

The image features a large, light blue rounded rectangle in the center. The word "KITZ" is written in a bold, white, sans-serif font across the middle of this rectangle. Below it, the words "GENERAL CATALOG" are written in a smaller, white, sans-serif font, extending across the width of the page. The background is a solid blue color with a dark blue triangle on the right side.

KITZ
GENERAL CATALOG

KITZ CORPORATION

The Reliable Brand

Since its establishment in 1951, KITZ Corporation has supplied products for applications ranging from those for homes to those for industrial processes, as a manufacturer of valves and other devices for the control of fluids.

Over the years, we have grown into one of the world's leading valve manufacturers. Today, the KITZ brand has a solid reputation for outstanding quality in Japan and worldwide.

As we enter a new century, concerns are growing about the global environment and access to sustainable sources of energy. We are simultaneously witnessing the advent of a society driven by sophisticated information and telecommunication technologies.

These developments will significantly alter our operating environment in the years ahead. KITZ Corporation is dedicated to increasing its corporate value through the provision of products and services rooted in originality and quality. We will focus on providing even greater satisfaction to our customers, shareholders, and the communities in which we operate.

KITZ Corporation will remain a manufacturer that concentrates on valves and other devices for controlling fluids, constantly working toward the goals of helping make our lives more fulfilling and earning the trust of all stakeholders.



A chrysanthemum-handle is a symbol of KITZ, the brand of valve reliability.

Product Lineup Targeting Requirements for Flow Control

Valves must be engineered to meet the demands of a broad spectrum of applications. Their designs need to match the material—whether water, gas, oil, or another substance—that is to be controlled. Temperature, pressure, control systems and other factors are also key considerations. With a diverse assortment of products, KITZ Corporation is able to meet every customer need involving valves.

Technology

Starting out as a manufacturer of manual valves, KITZ Corporation now employs advanced technology and quality control expertise to meet the present-day market needs with automated, centralized, and other sophisticated fluid control techniques.

Products that are even more innovative are being developed by sharing technology within the KITZ Group and through alliances with other companies.

This is what the KITZ brand stands for.

Production

An exclusive production system, extending from order receipt through development, manufacture, and delivery, eliminates waste, cuts costs, and speeds up deliveries.

Backing up the reliability of KITZ products further are exacting testing standards and a rigorous quality management program.

This is what the KITZ brand Stands for.

Major Production Locations

Japan

Plants in Japan handle everything from product development through manufacture, concentrating on value-added products. Priority is given to new markets, new materials, and new design functions. Japan also plays a vital role as the “control tower” for global manufacturing activities.

Taiwan

Utilizing expertise in materials and processing technologies, our production plants in Taiwan produce mainly steel valves. These valves are sold in Japan and other countries worldwide.

Spain

This plant is a supply base for EU customers. Its main products are steel ball valves.

Thailand

KITZ's plants in Thailand produce mainly copper alloy valves and butterfly valves. The plants combine sophisticated equipment with the just-in-time production method to achieve high productivity and adhere to the market-driven concept. These advantages make our plants in Thailand reliable suppliers of products to customers in many countries.

China

This country—often referred to as the world's factory—is an extremely cost-efficient location for manufacturing valves. The KITZ plants in China manufacture steel valves for industrial applications.

Global Marketing Network www.kitz.com



Bronze & Brass
 Cast Iron
 Ductile Iron
 Stainless Steel
 Carbon Steel
 Butterfly Valve
 Ball Valve
 Ball Valve Seat
 Actuated Valve

Bronze & Brass

S	GATE	4
H	GATE	4
E	GATE	4
FH	GATE	4
FR	GATE	4
M	GATE	4
L	GATE	4
LB	GATE	4
150S	GATE	4
CH	GATE	4
CFS	GATE	5
CFH	GATE	5
C150L	GATE	5
AKH	GATE	5
AKFS	GATE	5
AKFH	GATE	5
AK125E	GATE	5
AK125M	GATE	5
AK150E	GATE	5
AK150L	GATE	5
AK150LU	GATE	6
AK300LU	GATE	6
AS-FH	GATE	6
PN16S(N)	GATE	6
PN16FH	GATE	6
PN25S	GATE	6
A	GLOBE	6
Q	GLOBE	6
QA	GLOBE	6
G	GLOBE	6
C	GLOBE	7
CA	GLOBE	7
B	GLOBE	7
BH	GLOBE	7
D	GLOBE	7
DB	GLOBE	7
DBH	GLOBE	7
K	GLOBE	7
J	GLOBE	7
JB	GLOBE	7
300D	GLOBE	8
C150D	GLOBE	8
AKA	GLOBE	8
AKG	GLOBE	8
AKC	GLOBE	8
AKCA	GLOBE	8
AK125C	GLOBE	8
AK150D	GLOBE	8
AK300D	GLOBE	8
AK300J	GLOBE	8
PN16A(N)	GLOBE	9
PN25A	GLOBE	9
F	LIFT CHECK	9
R	SWING CHECK	9
O	SWING CHECK	9
OB	SWING CHECK	9
YR	SWING CHECK	9
10BWZ	WAFER CHECK	9
RF	LIFT CHECK	9
VF	LIFT CHECK	9
FT	FOOT CHECK	10
FTS	FOOT CHECK	10
150YR	SWING CHECK	10
CYR	SWING CHECK	10
CAF	LIFT CHECK	10
AKYR	SWING CHECK	10
AK150YR	SWING CHECK	10
AK300YR	SWING CHECK	10
AKAF	LIFT CHECK	10

PN16R(N)	SWING CHECK	10
PN25R	SWING CHECK	11
Y	Y TYPE STRAINER	11
CY	Y TYPE STRAINER	11
AKY	Y TYPE STRAINER	11
PN25YE	Y TYPE STRAINER	11
PN16YE	Y TYPE STRAINER	11
PN25YE	Y TYPE STRAINER	11

Cast Iron

10FCHI	GATE	16
10FCL	GATE	16
10FCLS	GATE	16
125FCHI	GATE	16
125FCL	GATE	16
125FCLS	GATE	16
125FCWI	GATE	16
10FCJ	GLOBE	16
10FCJS	GLOBE	16
125FCJ	GLOBE	16
125FCJS	GLOBE	17
10FCO	SWING CHECK	17
10FCOC	SWING CHECK	17
125FCO	SWING CHECK	17
10FWZ	WAFER CHECK	17
125FWNB	WAFER CHECK	17
125FWNBE	WAFER CHECK	17
PN16FWNB	WAFER CHECK	17
PN16FWNBME	WAFER CHECK	17
10FCY	Y TYPE STRAINER	18
125FCY	Y TYPE STRAINER	18

Ductile Iron

10SMS	GATE	22
10SMBF	GATE	22
10SMBOF	GATE	22
16SMB	GATE	22
16SMBO	GATE	22
16SMS	GATE	22
20SLS	GATE	22
150SMBO	GATE	22
10SJ	GLOBE	22
10SJBF	GLOBE	22
10SP	GLOBE	23
10SPBF	GLOBE	23
10SPBOF	GLOBE	23
10SPD	GLOBE	23
10SPDBF	GLOBE	23
10SPDBOF	GLOBE	23
10SD	GLOBE	23
10SDBF	GLOBE	23
10SDL	GLOBE	23
10SDLBF	GLOBE	23
16SP	GLOBE	24
16SPB	GLOBE	24
16SPBO	GLOBE	24
20SY	GLOBE	24
20SYB	GLOBE	24
150SPB	GLOBE	24
150SPDB	GLOBE	24
10SF	LIFT CHECK	24
10SFBF	LIFT CHECK	24
10SN	LIFT CHECK	24
10SNBF	LIFT CHECK	25
16SF	LIFT CHECK	25
16SFB	LIFT CHECK	25
20SN	LIFT CHECK	25
10SRBF	SWING CHECK	25
16SRB	SWING CHECK	25

20SOB	SWING CHECK	25
150SRB	SWING CHECK	25
10SWZU	WAFER CHECK	26
20SWZ	WAFER CHECK	26
20SWZU	WAFER CHECK	26
10FDY	Y TYPE STRAINER	26
10FDYBF	Y TYPE STRAINER	26
16FDY	Y TYPE STRAINER	26
16FDYB	Y TYPE STRAINER	26
20FDY	Y TYPE STRAINER	26

Stainless Steel

UE	B-SERIES GATE	30
UEM	B-SERIES GATE	30
UEB	B-SERIES GATE	30
UEBM	B-SERIES GATE	30
UEL	B-SERIES GATE	30
UELM	B-SERIES GATE	30
DKUELM	B-SERIES GATE	30
10UMA / 10UMAT	A-SERIES GATE	30
10UMAM / 10UMAMT	A-SERIES GATE	30
20UMA / 20UMAT	A-SERIES GATE	30
20UMAM / 20UMAMT	A-SERIES GATE	31
150UMA / 150UMAT	A-SERIES GATE	31
150UMAM / 150UMAMT	A-SERIES GATE	31
300UMA	A-SERIES GATE	31
300UMAM	A-SERIES GATE	31
600UMA	A-SERIES GATE	31
600UMAM	A-SERIES GATE	31
10UMAJ	AJ-SERIES GATE	32
20UMAJ	AJ-SERIES GATE	32
150UMAJ	AJ-SERIES GATE	32
300UMAJ	AJ-SERIES GATE	32
UAB	B-SERIES GLOBE	32
UCL	B-SERIES GLOBE	33
UCB	B-SERIES GLOBE	33
UD	B-SERIES GLOBE	33
UDM	B-SERIES GLOBE	33
UDB	B-SERIES GLOBE	33
UDBM	B-SERIES GLOBE	33
UJ	B-SERIES GLOBE	33
UJM	B-SERIES GLOBE	33
UJB	B-SERIES GLOBE	33
UJBM	B-SERIES GLOBE	33
10UPA / G-10UPA / 10UPAT	A-SERIES GLOBE	34
10UPAM / G-10UPAM / 10UPAMT	A-SERIES GLOBE	34
20UPA / G-20UPA / 20UPAT	A-SERIES GLOBE	34
20UPAM / G-20UPAM / 20UPAMT	A-SERIES GLOBE	34
150UPA / G-150UPA / 150UPAT	A-SERIES GLOBE	34
150UPAM / G-150UPAM / 150UPAMT	A-SERIES GLOBE	34
300UPA / G-300UPA	A-SERIES GLOBE	34
300UPAM / G-300UPAM	A-SERIES GLOBE	34
600UPA	A-SERIES GLOBE	34
600UPAM	A-SERIES GLOBE	34
10UPAJ	AJ-SERIES GLOBE	35
20UPAJ	AJ-SERIES GLOBE	35
150UPAJ	AJ-SERIES GLOBE	35
300UPAJ	AJ-SERIES GLOBE	35
10UPAW	A-SERIES GLOBE	35
10UPAWM	A-SERIES GLOBE	35
20UPAW	A-SERIES GLOBE	35
20UPAWM	A-SERIES GLOBE	35
150UPAW	A-SERIES GLOBE	35
150UPAWM	A-SERIES GLOBE	35
300UPAW	A-SERIES GLOBE	36
300UPAWM	A-SERIES GLOBE	36
UN	B-SERIES LIFT CHECK	36
UO	B-SERIES SWING CHECK	36
UOM	B-SERIES SWING CHECK	36
UOB	B-SERIES SWING CHECK	36

UOBM	B-SERIES SWING CHECK	36
10UNA / 10UNAT	A-SERIES LIFT CHECK	36
10UNAM / 10UNAMT	A-SERIES LIFT CHECK	36
20UNA / 20UNAT	A-SERIES LIFT CHECK	36
20UNAM / 20UNAMT	A-SERIES LIFT CHECK	37
150UNA / 150UNAT	A-SERIES LIFT CHECK	37
150UNAM	A-SERIES LIFT CHECK	37
300UNA	A-SERIES LIFT CHECK	37
300UNAM	A-SERIES LIFT CHECK	37
10UOA / 10UOAT	A-SERIES SWING CHECK	37
10UOAM / 10UOAMT	A-SERIES SWING CHECK	37
20UOA / 20UOAT	A-SERIES SWING CHECK	37
20UOAM / 20UOAMT	A-SERIES SWING CHECK	37
150UOA / 150UOAT	A-SERIES SWING CHECK	37
150UOAM / 150UOAMT	A-SERIES SWING CHECK	38
300UOA	A-SERIES SWING CHECK	38
300UOAM	A-SERIES SWING CHECK	38
600UOA	A-SERIES SWING CHECK	38
600UOAM	A-SERIES SWING CHECK	38
10UW	WAFER CHECK	38
10UWS	WAFER CHECK	38
10UNAJ	AJ-SERIES LIFT CHECK	39
10UNAJM	AJ-SERIES LIFT CHECK	39
20UNAJ	AJ-SERIES LIFT CHECK	39
150UNAJ	AJ-SERIES LIFT CHECK	39
300UNAJ	AJ-SERIES LIFT CHECK	39
10UOAJ	AJ-SERIES SWING CHECK	39
20UOAJ	AJ-SERIES SWING CHECK	39
150UOAJ	AJ-SERIES SWING CHECK	39
300UOAJ	AJ-SERIES SWING CHECK	39
10UFT	BALL CHECK	40
10UFTE	BALL CHECK	40
UY	B-SERIES Y TYPE STRAINER	40
UYM	B-SERIES Y TYPE STRAINER	40
UYB	B-SERIES Y TYPE STRAINER	40
UYBM	B-SERIES Y TYPE STRAINER	40
10UYA	A-SERIES Y TYPE STRAINER	40
10UYAM	A-SERIES Y TYPE STRAINER	40
20UYA	A-SERIES Y TYPE STRAINER	40
UN3-AP-	NEEDLE mm. Series	41
UN3-BP-	NEEDLE mm. Series	41
UN3-CP-	NEEDLE mm. Series	41
UN3-DP-	NEEDLE mm. Series	41
UN3-EP-	NEEDLE mm. Series	41
UN3-FP-	NEEDLE mm. Series	41
UN26-AP-	NEEDLE mm. Series	41
UN26-CP-	NEEDLE mm. Series	41
UN26-SP-	NEEDLE mm. Series	41
UN3-CP-	NEEDLE inch Series	41
UN3-DP-	NEEDLE inch Series	41
UN3-EP-	NEEDLE inch Series	41
UN3-FP-	NEEDLE inch Series	41
UN26-CP-	NEEDLE inch Series	41

Carbon Steel

10SCLS	GATE	46
20SCLS	GATE	46
150SCLS	GATE	46
300SCLS	GATE	46
10SCJS / G-10SCJS	GLOBE	46
20SCJS / G-20SCJS	GLOBE	46
150SCJS / G-150SCJS	GLOBE	46
300SCJS / G-300SCJS	GLOBE	46
10SCOS	SWING CHECK	46
20SCOS	SWING CHECK	46
150SCOS	SWING CHECK	47
300SCOS	SWING CHECK	47

Butterfly Valve

10XJME	BUTTERFLY	56
G-10XJME	BUTTERFLY	56
PN16XJME < ZOP01 >	BUTTERFLY	56
G-PN16XJME < ZOP01 >	BUTTERFLY	56
10DJ	BUTTERFLY	56
G-10DJ	BUTTERFLY	56
G-10DJUE	BUTTERFLY	56
G-16DJUE	BUTTERFLY	56
VG-10DJ	BUTTERFLY	56
PN16DJ	BUTTERFLY	56
G-PN16DJ	BUTTERFLY	57
PN16DJL	BUTTERFLY	57
G-PN16DJL	BUTTERFLY	57
PN25DJE	BUTTERFLY	57
PN25DJLE	BUTTERFLY	57
G-150DJ	BUTTERFLY	57
G-150DJL	BUTTERFLY	57
200DJ	BUTTERFLY	57
200DJL	BUTTERFLY	57
G-200DJ	BUTTERFLY	58
G-200DJL	BUTTERFLY	58
G-200DJLE	BUTTERFLY	58
250DJ	BUTTERFLY	58
G-250DJ	BUTTERFLY	58
G-250DJE	BUTTERFLY	58
250DJL	BUTTERFLY	58
G-250DJL	BUTTERFLY	58
G-250DJLE	BUTTERFLY	58
G-250DJA	BUTTERFLY	59
G-250DJA	BUTTERFLY	59
G-250DJLA	BUTTERFLY	59
G-250DJLAE	BUTTERFLY	59
10SHB	BUTTERFLY	59
16SHB	BUTTERFLY	59
150SHB	BUTTERFLY	59
G-10SHB	BUTTERFLY	59
G-16SHB	BUTTERFLY	59
G-150SHB	BUTTERFLY	59
10UB	BUTTERFLY	60
GL-10UB	BUTTERFLY	60
GL-150UB	BUTTERFLY	60
10NFJNE	BUTTERFLY	60
G-10NFJNE	BUTTERFLY	60
10NFJNW	BUTTERFLY	60
G-10NFJNW	BUTTERFLY	60
10D	DAMPER	60
GL-10D	DAMPER	60
GL-10A	DAMPER	60
UV	BUTTERFLY	61
FV	BUTTERFLY	61
PN10EJMF	BUTTERFLY	61
PN10EJMQ	BUTTERFLY	61
PN10EJMW	BUTTERFLY	61

Ball Valve

T	FLOATING BALL	74
AKT	FLOATING BALL	74
TT	FLOATING BALL	74
TO	FLOATING BALL	74
TG	FLOATING BALL	74
TB	FLOATING BALL	74
TL	FLOATING BALL	74
TLT	FLOATING BALL	74
TFJ	FLOATING BALL	74
TM	FLOATING BALL	74
TK	FLOATING BALL	75

AKTK	FLOATING BALL	75
TKT	FLOATING BALL	75
TKW	FLOATING BALL	75
TN	3WAY FLOATING BALL	75
AKTN	3WAY FLOATING BALL	75
T4T	3WAY FLOATING BALL	75
T4L	3WAY FLOATING BALL	75
AK3TM	3 PIECE FLOATING BALL	75
AKTAF	FLOATING BALL	75
AKTAFM	FLOATING BALL	76
SZA	FLOATING BALL	76
AKSZA	FLOATING BALL	76
PN40SZA	FLOATING BALL	76
AKSZAW	FLOATING BALL	76
AKTAFLL	FLOATING BALL	76
10FCT	FLOATING BALL	76
10FCTB	FLOATING BALL	76
10FCTR	FLOATING BALL	76
125FCTB	FLOATING BALL	76
125FCTR	FLOATING BALL	77
10FCTB2L	3WAY FLOATING BALL	77
10FCTR2L	3WAY FLOATING BALL	77
STZ	FLOATING BALL	77
20ST	FLOATING BALL	77
10STBF	FLOATING BALL	77
10STB4TAF	3WAY FLOATING BALL	77
10STB4LAF	3WAY FLOATING BALL	77
10STR4TAF	3WAY FLOATING BALL	77
10STR4LAF	3WAY FLOATING BALL	77
10STLBF	FLOATING BALL	78
20STLB	FLOATING BALL	78
UTK	FLOATING BALL	78
UTKM	FLOATING BALL	78
UTKW	FLOATING BALL	78
UTKMW	FLOATING BALL	78
UTFM	FLOATING BALL	78
UTH	FLOATING BALL	78
UTHM	FLOATING BALL	78
UTHL	FLOATING BALL	78
UTH4LM	3WAY FLOATING BALL	79
UTH4TM	3WAY FLOATING BALL	79
U3TZM	3 PIECE FLOATING BALL	79
SWU3TZM	3 PIECE FLOATING BALL	79
10UT	FLOATING BALL	79
10UTB / G-10UTB	FLOATING BALL	79
10UTDZ	FLOATING BALL	79
10UTDZM	FLOATING BALL	79
20UTDZ	FLOATING BALL	79
20UTDZM	FLOATING BALL	79
10UTR	FLOATING BALL	80
20UTR	FLOATING BALL	80
150UTB / G-150UTB	FLOATING BALL	80
150UTBM	FLOATING BALL	80
150UTDZ / G-150UTDZ	FLOATING BALL	80
150UTDZM / G-150UTDZM	FLOATING BALL	80
300UTDZ	FLOATING BALL	80
300UTDZM	FLOATING BALL	80
150UTR	FLOATING BALL	80
300UTR	FLOATING BALL	80
10UTB2T	3WAY FLOATING BALL	81
10UTB2TM	3WAY FLOATING BALL	81
10UTB2L	3WAY FLOATING BALL	81
10UTR2L	3WAY FLOATING BALL	81
10UTB2LM	3WAY FLOATING BALL	81
10UTB4LA	3WAY FLOATING BALL	81
10UTB4LAM	3WAY FLOATING BALL	81
10UTB4TA	3WAY FLOATING BALL	81
10UTB4TAM	3WAY FLOATING BALL	81
10UTBLN	FLOATING BALL	81
10UTBT	FLOATING BALL	82
10UTBJ	FLOATING BALL	82

10UTBJM	FLOATING BALL	82
150UTBJ	FLOATING BALL	82
300UTBJ	FLOATING BALL	82
L-10UVC	LAMBDA PORT	82
L-150UVC / G-150UVC	LAMBDA PORT	82
10UTDZ1H	FLOATING BALL	82
10UTDZ1HM	FLOATING BALL	82
20UTDZ1H / G-20UTDZ1H	FLOATING BALL	82
10UTDZ3H / G-10UTDZ3H	FLOATING BALL	83
20UTDZ3H / G-20UTDZ3H	FLOATING BALL	83
10UTDZ5H / G-10UTDZ5H	FLOATING BALL	83
20UTDZ5H / G-20UTDZ5H	FLOATING BALL	83
10UTDZ6H / G-10UTDZ6H	FLOATING BALL	83
10UTDZ6HM / G-10UTDZ6HM	FLOATING BALL	83
20UTDZ6H / G-20UTDZ6H	FLOATING BALL	83
150UTDZ / G-150UTDZ	FLOATING BALL	83
150UTDZ1H / G-150UTDZ1H	FLOATING BALL	83
150UTDZ1HM / G-150UTDZ1HM	FLOATING BALL	83
300UTDZ1H	FLOATING BALL	84
300UTDZ1HM	FLOATING BALL	84
150UTDZ3H / G-150UTDZ3H	FLOATING BALL	84
150UTDZ3HM / G-150UTDZ3HM	FLOATING BALL	84
300UTDZ3H / G-300UTDZ3H	FLOATING BALL	84
300UTDZ3HM / G-300UTDZ3HM	FLOATING BALL	84
150UTDZ5H / G-150UTDZ5H	FLOATING BALL	84
150UTDZ5HM / G-150UTDZ5HM	FLOATING BALL	84
300UTDZ5H / G-300UTDZ5H	FLOATING BALL	84
300UTDZ5HM / G-300UTDZ5HM	FLOATING BALL	84
150UTDZ6H / G-150UTDZ6H	FLOATING BALL	85
150UTDZ6HM / G-150UTDZ6HM	FLOATING BALL	85
300UTDZ6H / G-300UTDZ6H	FLOATING BALL	85
300UTDZ6HM / G-300UTDZ6HM	FLOATING BALL	85
150UTDZXL / G-150UTDZXL	FLOATING BALL	85
300UTDZXL / G-300UTDZXL	FLOATING BALL	85
SCTK	FLOATING BALL	85
10SCTDZ	FLOATING BALL	85
20SCTDZ	FLOATING BALL	85
150SCTDZ / G-150SCTDZ	FLOATING BALL	85
150SCTDZM	FLOATING BALL	86
300SCTDZ	FLOATING BALL	86
300SCTDZM	FLOATING BALL	86
10SCTDZ1H	FLOATING BALL	86
20SCTDZ1H / G-20SCTDZ1H	FLOATING BALL	86
150SCTDZ1H / G-150SCTDZ1H	FLOATING BALL	86
300SCTDZ1H / G-300SCTDZ1H	FLOATING BALL	86
10SCTDZ3H / G-10SCTDZ3H	FLOATING BALL	86
20SCTDZ3H / G-20SCTDZ3H	FLOATING BALL	86
150SCTDZ3H / G-150SCTDZ3H	FLOATING BALL	86
300SCTDZ3H / G-300SCTDZ3H	FLOATING BALL	87
10SCTDZ5H / G-10SCTDZ5H	FLOATING BALL	87
20SCTDZ5H / G-20SCTDZ5H	FLOATING BALL	87
150SCTDZ5H / G-150SCTDZ5H	FLOATING BALL	87
300SCTDZ5H / G-300SCTDZ5H	FLOATING BALL	87
10SCTDZ6H / G-10SCTDZ6H	FLOATING BALL	87
20SCTDZ6H / G-20SCTDZ6H	FLOATING BALL	87
150SCTDZ6H / G-150SCTDZ6H	FLOATING BALL	87
300SCTDZ6H / G-300SCTDZ6H	FLOATING BALL	87

Ball Valve Seat

90

Actuated Valve

EA100/200-TE	FLOATING BALL	106
EA100/200-TFE	FLOATING BALL	106
EA100/200-TNE	3WAY FLOATING BALL/3WAY TRUNNION BALL	106
EA100/200-UTE	FLOATING BALL	106
EA100/200-UTFE	FLOATING BALL	106
EA100/200-UTGE	FLOATING BALL	106
EA100/200-UTNE	3WAY FLOATING BALL	106

ED12/24-TE	FLOATING BALL/TRUNNION BALL	106
ED12/24-TNE	3WAY FLOATING BALL/3WAY TRUNNION BALL	106
ED12/24-UTE	FLOATING BALL	106
ED12/24-UTFE	FLOATING BALL/TRUNNION BALL	107
ED12/24-UTGE	FLOATING BALL	107
EXS100/200-10DJ	BUTTERFLY	107
EXS100/200-10DJE	BUTTERFLY	107
EXS100/200-10XJME	BUTTERFLY	107
C-TE	FLOATING BALL/TRUNNION BALL	108
C-TFE	FLOATING BALL/TRUNNION BALL	108
C-TLE	FLOATING BALL/TRUNNION BALL	108
C-TNE	3WAY FLOATING BALL/3WAY TRUNNION BALL	108
C-TUE	FLOATING BALL	108
C-UTE	FLOATING BALL	108
C-UTGE	FLOATING BALL	108
C-UTNE	3WAY FLOATING BALL	108
CS-TE	FLOATING BALL	108
CS-TLE	FLOATING BALL	108
CS-TNE	3WAY FLOATING BALL	109
CS-TUE	FLOATING BALL	109
CS-UTE	FLOATING BALL	109
CS-UTGE	FLOATING BALL	109
CS-UTNE	3WAY FLOATING BALL	109
FA-10FCT	FLOATING BALL	109
FA-10FCTB	FLOATING BALL	109
FA-10FCTB2L	3WAY FLOATING BALL	109
FA-10SCTDZ	FLOATING BALL	109
FA-10UT	FLOATING BALL	109
FA-10UTB2L	3WAY FLOATING BALL	110
FA-10UTB4LA	3WAY FLOATING BALL	110
FA-10UTBLN	FLOATING BALL	110
FA-10UTDZ	FLOATING BALL	110
FA-150SCTDZ	FLOATING BALL	110
FA-150UTDZ	FLOATING BALL	110
FA-20SCTDZ	FLOATING BALL	110
FA-20UTDZ	FLOATING BALL	110
FA-300SCTDZ	FLOATING BALL	110
FA-300UTDZ	FLOATING BALL	110
FA-300UTDZM	FLOATING BALL	111
FA-10XJME	BUTTERFLY	111
FA-10DJ	BUTTERFLY	111
FA-10DJE	BUTTERFLY	111
FAS-10FCT	FLOATING BALL	111
FAS-10FCTB	FLOATING BALL	111
FAS-10FCTB2L	3WAY FLOATING BALL	111
FAS-10SCTDZ	FLOATING BALL	111
FAS-10UT	FLOATING BALL	111
FAS-10UTB2L	3WAY FLOATING BALL	111
FAS-10UTB4LA	3WAY FLOATING BALL	112
FAS-10UTBLN	FLOATING BALL	112
FAS-10UTDZ	FLOATING BALL	112
FAS-150SCTDZ	FLOATING BALL	112
FAS-150UTDZ	FLOATING BALL	112
FAS-150UTDZM	FLOATING BALL	112
FAS-20SCTDZ	FLOATING BALL	112
FAS-20UTDZ	FLOATING BALL	112
FAS-300SCTDZ	FLOATING BALL	112
FAS-300UTDZ	FLOATING BALL	112
FAS-300UTDZM	FLOATING BALL	113
FAS-10XJME	BUTTERFLY	113
FAS-10DJ	BUTTERFLY	113
FAS-10DJE	BUTTERFLY	113
FAS-10LJF	BUTTERFLY	113
B-10FCT	FLOATING BALL	113
B-10FCTB	FLOATING BALL	113
B-10FCTB2L	3WAY FLOATING BALL	113
B-10STLBF	FLOATING BALL	113
B-10UT	FLOATING BALL	113
B-10UTDZ	FLOATING BALL	114
B-10UTDZM	FLOATING BALL	114
B-10SCTDZ	FLOATING BALL	114

B-10UTB2L	3WAY FLOATING BALL	114
B-10UTB4LA	3WAY FLOATING BALL	114
B-10UTBLN	FLOATING BALL	114
B-150SCTDZ	FLOATING BALL	114
B-150UTDZ	FLOATING BALL	114
B-150UTDZM	FLOATING BALL	114
B-20SCTDZ	FLOATING BALL	114
B-20UTDZ	FLOATING BALL	115
B-20UTDZM	FLOATING BALL	115
B-300SCTDZ	FLOATING BALL	115
B-300UTDZ	FLOATING BALL	115
B-300UTDZM	FLOATING BALL	115
B-10DJ	BUTTERFLY	115
B-10DJE	BUTTERFLY	115
B-10LJF	BUTTERFLY	115
BS-10FCT	FLOATING BALL	115
BS-10FCTB	FLOATING BALL	115
BS-10FCTB2L	3WAY FLOATING BALL	116
BS-10STLBF	FLOATING BALL	116
BS-10UT	FLOATING BALL	116
BS-10UTDZ	FLOATING BALL	116
BS-10UTDZM	FLOATING BALL	116
BS-10SCTDZ	FLOATING BALL	116
BS-10UTB2L	3WAY FLOATING BALL	116
BS-10UTB4LA	3WAY FLOATING BALL	116
BS-10UTBLN	FLOATING BALL	116
BS-10UVC	LAMBDA PORT	116
BS-150SCTDZ	FLOATING BALL	117
BS-150UTDZ	FLOATING BALL	117
BS-20SCTDZ	FLOATING BALL	117
BS-20UTDZ	FLOATING BALL	117
BS-20UTDZM	FLOATING BALL	117
BS-300SCTDZ	FLOATING BALL	117
BS-300UTDZ	FLOATING BALL	117
BS-300UTDZM	FLOATING BALL	117
BS-10DJ	BUTTERFLY	117
BS-10DJE	BUTTERFLY	117
BS-10LJF	BUTTERFLY	118
BSW-10LJF	BUTTERFLY	118

BRONZE & BRASS

Presenting Design Features of KITZ Bronze/Brass Valves

Human Engineering in Handwheel Design

Computer-designed handwheels of all KITZ bronze/brass valves, the product of KITZ human engineering, are featured with an ideal combination of operational efficiency and high mechanical strength for reliability.

Asbestos-free Gland Packings

All KITZ bronze/brass gate and globe valves employ aramid fiber PTFE as the material of the asbestos-free gland packing, meeting the latest industrial demand to minimize pollution concerns. With its leak-free sealing performance and reduced valve operating torque, aramid fiber PTFE is considered a reliable substitution for conventional asbestos sheets for the service of water, oil, gas and saturated steam pressure of a maximum 300 psi within the temperature range of 300°C.

Pressure Rating

The pressure rating designation of KITZ valves follows the accepted practice of the present-day valve and pipe fitting industry. Each product is rated for W.O.G. (non-shock cold water, oil, and gas*) and saturated steam pressure service.

*Please refer to our website (www.kitz.co.jp) or contact KITZ for details.

Inspection and Testing

KITZ valves are manufactured under strict quality control throughout all stages of production, beginning with the inspection of the chemical composition and mechanical properties of materials. Extra care is given to inspection and testing at all machine shops and assembly plants, with the utilization of up-to-date precision equipment. All KITZ valves are subjected to strict pressure testing of the body and seat sealing to ensure a long service life and quality performance.

*The valves introduced in this catalog are not designed to handle toxic gases. Use specially designed or certified valves for flammable gas service.

Pressure-Temperature Ratings of PN Series Valves

Maximum permissible working pressure (bar)

Service temperature (°C)	Bronze & Brass valves		
	PN16	PN20	PN25
-10 to 66			
100	16.0	20.0	25.0
120	13.5	17.2	21.8
150	9.5	13.0	16.5
170	7.0	10.3	12.8
180	-	9.0	11.3
186	-	-	10.5
198	-	-	-
200	-	-	-

(Note) : Intermediate values may be obtained by linear interpolation.


Bronze/Brass Valve Solder Joints

Copper tubing is widely used with bronze/brass valves in steam and waterline applications in schools, hospitals, hotels, and private houses because of its excellent physical characteristics. It resists corrosion, meets sanitation requirements, and is easy to install.

Copper Tubes: There are three types of copper tubing for complying with ASTM B88, as listed below.

Each type is provided with a different wall thickness to meet application requirements.

Type K	For use in steam, oil, and gas lines for underground installation and/or severe conditions.
Type L	For general cooling and heating systems and related water piping and ventilation systems.
Type M	For home air-conditioning and heating applications.

 CAUTION	Solder-jointed end valves should not be used in service where the temperature of the line fluid is higher than the softening point of the solder.
----------------------------------------------------------------------------------------------------	---------------------------------------------------------------------------------------------------------------------------------------------------

Soldering Leak-free Joints

Use a solder of 95-5 tin-antimony or 96-4 tin-silver, and an open-flame torch. Keep the torch temperature relatively low to ensure a firmly soldered joint. Because the solder melting point is around 500°F (260°C), jointed valves cannot be used for high-temperature service.

Solder P-T Rating

Solder	Max. temp. (°C)	Max. working pressure					
		size 1/4 ^B to 1 ^B		size 1 1/4 ^B to 2 ^B		size 2 1/4 ^B to 4 ^B	
		MPa	psi	MPa	psi	MPa	psi
95-5 tin-antimony [H95 Sb-5A]	38	3.45	500	2.76	400	2.07	300
	66	2.76	400	2.41	350	1.90	275
96-4 tin-silver [H96 Ag-3.5A]	93	2.07	300	1.72	250	1.38	200
	121	1.38	200	1.21	175	1.03	150

KITZ Bronze and Brass Materials to JIS Standards

JIS H5120-2009 (Copper & Copper Alloy Castings)

Cast bronze Class 6	Designation	Chemical composition (%)										Mechanical properties	
		Cu	Sn	Zn	Pb	Ni	Fe	P	Sb	Al	Si	Tensile strength 195 Min. (N/mm ²)	Elongation (%) 15 Min.
	CAC406 (BC6)	83.0-87.0	4.0-6.0	4.0-6.0	4.0-6.0	1.0 Max.	0.3 Max.	0.05 Max.	0.2 Max.	0.01 Max.	0.01 Max.		

JIS H3250-2015 (Copper & Copper Alloy Rods and Bars)

Forged brass Alloy No.3771	Designation		Chemical composition (%)				Mechanical properties	
	Extruded	Drawn	Cu	Pb	Fe + Sn	Zn	Tensile strength 315 Min. (N/mm ²)	Elongation (%) 15 Min.
	C3771BE	C3771BD	57.0-61.0	1.0-2.5	1.0 Max.	Remainder		

JIS H3250-2015 (Copper & Copper Alloy Rods and Bars)

Free-cutting brass Alloy No.3604	Designation		Chemical composition (%)					Mechanical properties	
	Extruded	Drawn	Cu	Pb	Fe	Fe + Sn	Zn	Tensile strength 335 Min. (N/mm ²)	Elongation (%) -
	C3604BE	C3604BD	57.0-61.0	1.8-3.7	0.5 Max.	1.0 Max.	Remainder		

KITZ Bronze and Brass Materials to ASTM Standards

ASTM B62-2009

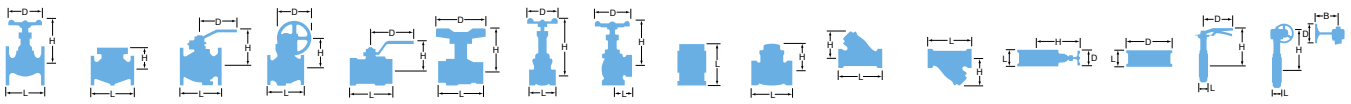
Chemical composition (%)											Mechanical properties		
Copper	Tin	Lead	Zinc	Nickel & Cobalt	Iron	Sulfur	Phosphorus	Antimony	Aluminum	Silicon	Minimum		
84.0-86.0	4.0-6.0	4.0-6.0	4.0-6.0	1.0 Max.	0.30 Max.	0.08 Max.	0.05 Max.	0.25 Max.	0.005 Max.	0.005 Max.	Tensile strength 30 ksi	Yield strength 14 ksi	Elongation in 2 in. 20%

ASTM B584 C84400-2014

Chemical composition (%)											Mechanical properties		
Copper	Tin	Lead	Zinc	Nickel & Cobalt	Iron	Sulfur	Phosphorus	Antimony	Aluminum	Silicon	Minimum		
78.0-82.0	2.3-3.5	6.0-8.0	7.0-10.0	1.0 Max.	0.40 Max.	0.08 Max.	0.02 Max.	0.25 Max.	0.005 Max.	0.005 Max.	Tensile strength 29 ksi	Yield strength 13 ksi	Elongation in 2 in. 18%

ASTM B283 C37700-2014

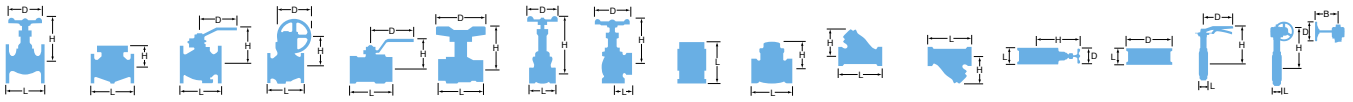
Chemical composition (%)				Mechanical properties		
Copper	Lead	Iron	Zinc	Minimum		
58.0-61.0	1.5-2.5	0.30 Max.	Remainder	Tensile strength 50 ksi	Yield strength 18 ksi	Elongation in 4x thickness 25%



Bronze & Brass
 Cast Iron
 Ductile Iron
 Stainless Steel
 Carbon Steel
 Butterfly Valve
 Ball Valve
 Actuated Valve

TYPE		GATE					GATE					GATE					GATE					GATE				
Bronze&Brass																										
FIG		S					H					E					FH					FR				
PRESSURE		Class 125					Class 125					Class 150					Class 125					Class 125				
END CONNECTION		BS21 (JIS B0203)					BS21 (JIS B0203)					BS21 (JIS B0203)					BS21 (JIS B0203)					BS21 (JIS B0203)				
DIMENSIONS		inch	mm	L	H	D	L	H	D	L	H	D	L	H	D	L	H	D	L	H	D	L	H	D		
	1/4	8	—	—	—	—	—	—	—	—	—	—	35	70	50	—	—	—	—	—	—	—	—	—		
	3/8	10	38	75	50	42	74	50	43	86	50	38	73	50	38	73	50	42	73	50	42	73	50			
	1/2	15	42	75	50	45	80	50	48	96	55	42	73	50	42	73	50	42	73	50	42	73	50			
	3/4	20	47	86	55	50	90	55	53	111	60	47	87	55	47	87	55	47	87	55	47	87	55			
	1	25	50	97	60	57	105	60	62	122	70	50	97	60	50	97	60	50	97	60	50	97	60			
	1 1/4	32	60	117	70	61	118	70	69	141	80	60	118	70	60	117	70	60	117	70	60	117	70			
	1 1/2	40	63	126	80	67	135	80	75	164	90	63	126	80	63	126	80	63	126	80	63	126	80			
	2	50	72	154	90	74	159	90	86	197	100	72	154	90	72	154	90	72	154	90	72	154	90			
	2 1/2	65	80	167	100	90	202	115	105	225	115	82	187	100	—	—	—	—	—	—	—	—	—			
	3	80	90	200	115	100	223	135	116	261	135	92	205	115	—	—	—	—	—	—	—	—	—			
	4	100	—	—	—	121	280	155	—	—	—	—	—	—	—	—	—	—	—	—	—	—	—			
BODY		Cast Bronze					Cast Bronze					Cast Bronze					Forged Brass					Forged Brass				
BONNET		Forged Brass					Cast Bronze					Forged Brass / Cast Bronze					Forged Brass					Forged Brass				
STEM		Special Brass					Special Brass					Special Brass					Special Brass					Special Brass				
DISC		Forged Brass					Cast Bronze / Special Brass					Cast Bronze					Forged Brass					Forged Brass				
		Non-rising Stem					Non-rising Stem					Non-rising Stem					Non-rising Stem					Non-rising Stem				

TYPE		GATE					GATE					GATE					GATE					GATE				
Bronze&Brass																										
FIG		M					L					LB					150S					CH				
PRESSURE		5K					10K					10K					Class 150					Class 125				
END CONNECTION		BS21 (JIS B0203)					BS21 (JIS B0203)					JIS B2011					BS21 (JIS B0203)					ASME B16.18				
DIMENSIONS		inch	mm	L	H	D	L	H	D	L	H	D	L	H	D	L	H	D	L	H	D	L	H	D		
	3/8	10	—	—	—	—	—	—	—	—	—	—	—	—	—	39	74	50	—	—	—	—	—	—		
	1/2	15	50	126	60	55	126	60	—	—	—	42	75	50	46	80	50	—	—	—	—	—	—	—		
	3/4	20	60	145	60	65	151	70	90	153	70	47	86	55	61	90	55	—	—	—	—	—	—	—		
	1	25	65	169	70	70	176	80	100	178	80	50	97	60	72	105	60	—	—	—	—	—	—	—		
	1 1/4	32	75	209	90	80	219	90	110	223	90	60	117	70	78	118	70	—	—	—	—	—	—	—		
	1 1/2	40	85	239	100	90	250	100	125	254	100	63	126	80	87	135	80	—	—	—	—	—	—	—		
	2	50	95	285	115	100	292	115	140	302	115	72	154	90	102	159	90	—	—	—	—	—	—	—		
	2 1/2	65	115	366	135	120	376	155	170	376	155	80	167	100	115	202	115	—	—	—	—	—	—	—		
	3	80	130	428	155	140	436	180	190	436	180	90	200	115	130	223	135	—	—	—	—	—	—	—		
	4	100	—	—	—	—	—	—	220	327	225	—	—	—	173	280	155	—	—	—	—	—	—	—		
BODY		Cast Bronze					Cast Bronze					Cast Bronze					Cast Bronze					Cast Bronze				
BONNET		Cast Bronze					Cast Bronze					Cast Bronze					Forged Brass					Cast Bronze				
STEM		Special Brass					Special Brass					Special Brass					Special Brass					Special Brass				
DISC		Cast Bronze					Cast Bronze					Cast Bronze					Forged Brass					Cast Bronze / Special Brass				
																	Non-rising Stem					Solder end joint Non-rising Stem				



TYPE		GATE					GATE			GATE			GATE			GATE		
Bronze&Brass																		
FIG		CFS					CFH			C150L			AKH			AKFS		
PRESSURE		Class 125					Class 125			Class 150			Class 125			ASME B1.20.1		
END CONNECTION		ASME B16.18					ASME B16.18			ASME B16.18			ASME B1.20.1			ASME B1.20.1		
DIMENSIONS		inch	mm	L	H	D	L	H	D	L	H	D	L	H	D	L	H	D
		3/8	10	—	—	—	37	77	50	—	—	—	42	74	50	38	73	50
		1/2	15	45	75	50	45	77	50	49	137	55	45	80	50	42	73	50
		3/4	20	60	86	55	60	87	55	64	157	70	50	90	55	47	87	55
		1	25	70	97	60	70	97	60	76	180	70	57	105	60	50	97	60
		1 1/4	32	77	117	70	77	118	70	82	216	80	61	118	70	60	118	70
		1 1/2	40	86	126	80	86	126	80	86	257	90	67	135	80	63	126	80
		2	50	104	154	90	104	154	90	109	296	100	74	159	90	72	154	90
		2 1/2	65	—	—	—	115	187	100	—	—	—	90	202	115	80	167	100
		3	80	—	—	—	127	205	115	—	—	—	100	223	135	90	200	115
		4	100	—	—	—	—	—	—	—	—	—	121	280	155	—	—	—
BODY		Forged Brass					Forged Brass			Cast Bronze			Cast Bronze			Forged Brass		
BONNET		Forged Brass					Forged Brass			Cast Bronze			Cast Bronze			Forged Brass		
STEM		Special Brass					Special Brass			Cast Bronze			Special Brass			Special Brass		
DISC		Forged Brass					Forged Brass			Cast Bronze			Cast Bronze / Special Brass			Forged Brass		
		Solder end joint Non-rising Stem					Solder end joint Non-rising Stem			Solder end joint			Non-rising Stem			Non-rising Stem		

TYPE		GATE					GATE			GATE			GATE			GATE		
Bronze&Brass																		
FIG		AKFH					AK125E			AK125M			AK150E			AK150L		
PRESSURE		Class 125					Class 125			Class 125			Class 150			Class 150		
END CONNECTION		ASME B1.20.1					ASME B1.20.1			ASME B1.20.1			ASME B1.20.1			ASME B1.20.1		
DIMENSIONS		inch	mm	L	H	D	L	H	D	L	H	D	L	H	D	L	H	D
		1/4	8	35	70	50	—	—	—	—	—	—	—	—	—	—	—	—
		3/8	10	38	73	50	43	86	50	—	—	—	43	86	50	—	—	—
		1/2	15	42	73	50	49	93	55	51	129	55	49	98	55	51	137	55
		3/4	20	47	87	55	53	110	60	56	155	60	53	114	70	56	157	70
		1	25	50	97	60	61	126	70	66	180	70	61	126	70	66	180	70
		1 1/4	32	60	118	70	64	145	80	68	216	80	68	145	80	68	216	80
		1 1/2	40	63	126	80	68	170	90	74	257	90	74	176	90	74	257	90
		2	50	72	154	90	74	189	100	84	296	100	84	201	100	84	296	100
		2 1/2	65	82	187	100	—	—	—	115	371	135	—	—	—	120	385	155
		3	80	92	205	115	—	—	—	130	432	155	—	—	—	140	432	155
BODY		Forged Brass					Cast Bronze			Cast Bronze			Cast Bronze			Cast Bronze		
BONNET		Forged Brass					Cast Bronze			Cast Bronze			Cast Bronze			Cast Bronze		
STEM		Special Brass					Cast Bronze			Cast Bronze			Cast Bronze			Cast Bronze		
DISC		Forged Brass					Cast Bronze			Cast Bronze			Cast Bronze			Cast Bronze		
		Non-rising Stem					Non-rising Stem						Non-rising Stem					

Bronze & Brass

Cast Iron

Ductile Iron

Stainless Steel

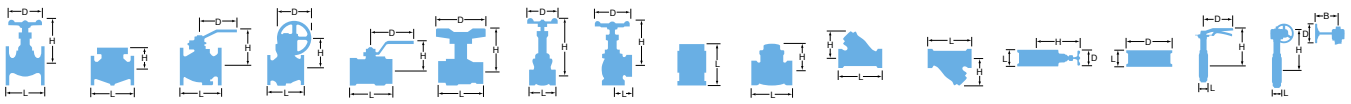
Carbon Steel

Butterfly Valve

Ball Valve

Ball Valve Seal

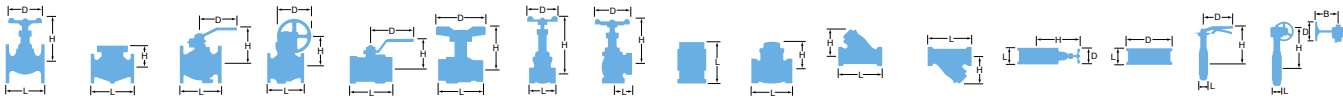
Actuated Valve



Bronze & Brass
 Cast Iron
 Ductile Iron
 Stainless Steel
 Carbon Steel
 Butterfly Valve
 Ball Valve
 Ball Valve Seat
 Actuated Valve

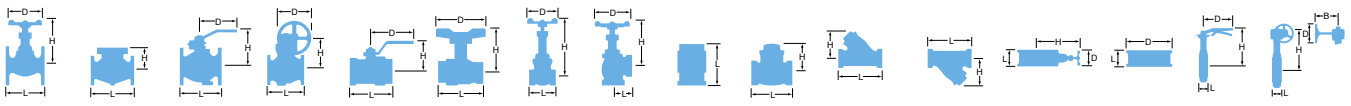
TYPE		GATE					GATE					GATE					GATE									
Bronze&Brass																										
FIG		AK150LU					AK300LU					AS-FH					PN16S					PN16FH				
PRESSURE		Class 150					Class 300					PN16					PN16					PN16				
END CONNECTION		ASME B1.20.1					ASME B1.20.1					AS 1722.1					BS21 (JIS B0203)					BS21 (JIS B0203)				
DIMENSIONS		inch	mm	L	H	D	L	H	D	L	H	D	L	H	D	L	H	D	L	H	D					
	1/4	8	45	108	50	—	—	—	—	—	—	—	—	—	—	35	70	50								
	3/8	10	46	108	50	46	125	60	—	—	—	—	—	—	—	38	73	50								
	1/2	15	51	137	55	51	149	70	55	74	55	42	75	50	42	73	50									
	3/4	20	56	157	70	56	173	80	60	86	55	47	86	55	47	87	55									
	1	25	66	180	70	66	194	80	68	94	60	50	97	60	50	97	60									
	1 1/4	32	68	216	80	74	228	100	78	116	70	60	117	70	60	118	70									
	1 1/2	40	74	257	90	84	274	115	81	128	80	63	126	80	63	126	80									
	2	50	84	297	100	98	313	135	94	158	90	72	154	90	72	154	90									
	2 1/2	65	—	—	—	—	—	—	—	—	—	—	—	—	—	82	187	100								
	3	80	—	—	—	—	—	—	—	—	—	—	—	—	—	92	205	115								
BODY		Cast Bronze					Cast Bronze					Dezincification Resistance Brass					Cast Bronze					Forged Brass				
BONNET		Cast Bronze					Cast Bronze					Dezincification Resistance Brass					Forged Brass					Forged Brass				
STEM		Cast Bronze					Cast Bronze					Dezincification Resistance Brass					Special Brass					Special Brass				
DISC		Cast Bronze					Cast Bronze					Dezincification Resistance Brass					Forged Brass					Forged Brass				
												Non-rising Stem					Non-rising Stem					Non-rising Stem				

TYPE		GATE					GLOBE					GLOBE					GLOBE					GLOBE				
Bronze&Brass																										
FIG		PN25S					A					Q					QA					G				
PRESSURE		PN25					Class 100					Class 100					Class 100					Class 125				
END CONNECTION		BS21 (JIS B0203)					BS21 (JIS B0203)					BS21 (JIS B0203)					BS21 (JIS B0203)					BS21 (JIS B0203)				
DIMENSIONS		inch	mm	L	H	D	L	H	D	L	H	D	L	H	D	L	H	D	L	H	D					
	1/4	8	—	—	—	40	66	50	—	—	—	—	—	—	—	47	68	50								
	3/8	10	—	—	—	42	67	50	—	—	—	—	—	—	—	53	88	55								
	1/2	15	75	75	50	48	69	55	44	70	50	44	70	50	57	100	60									
	3/4	20	86	86	55	53	80	60	50	73	55	50	73	55	66	110	70									
	1	25	97	97	60	63	94	70	63	86	60	63	86	60	76	120	80									
	1 1/4	32	117	117	70	73	104	80	—	—	—	73	108	80	88	140	90									
	1 1/2	40	126	126	80	81	127	90	—	—	—	81	132	90	100	156	100									
	2	50	154	154	90	94	147	100	—	—	—	94	150	100	120	185	115									
	2 1/2	65	—	—	—	115	179	115	—	—	—	—	—	—	147	210	135									
	3	80	—	—	—	131	200	135	—	—	—	—	—	—	162	229	155									
	4	100	—	—	—	171	250	180	—	—	—	—	—	—	—	—	—									
BODY		Cast Bronze					Cast Bronze					Cast Bronze					Cast Bronze					Cast Bronze				
BONNET		Forged Brass					Forged Brass / Cast Bronze					Forged Brass					Forged Brass					Forged Brass / Cast Bronze				
STEM		Special Brass					Special Brass					Special Brass					Special Brass					Special Brass				
DISC		Forged Brass					Cast Bronze					Uletan Rubber					PTFE					G/F PTFE				
		Non-rising Stem										Soft Seated disc					Soft Seated disc					Soft Seated disc				



TYPE	GLOBE					GLOBE			GLOBE			GLOBE			GLOBE		
Bronze&Brass																	
FIG	C					CA			B			BH			D		
PRESSURE	Class 150					Class 150			Class 150			Class 150			Class 150		
END CONNECTION	BS21 (JIS B0203)					BS21 (JIS B0203)			JIS B2240			JIS B2240			BS21 (JIS B0203)		
DIMENSIONS	inch	mm	L	H	D	L	H	D	L	H	D	L	H	D	L	H	D
	1/4	8	44	66	50	21	66	50	—	—	—	—	—	—	—	—	—
	3/8	10	44	68	50	24	68	50	—	—	—	—	—	—	—	—	—
	1/2	15	53	79	60	28	79	60	83	79	60	83	79	60	64	113	60
	3/4	20	65	93	70	34	93	70	88	94	70	88	94	70	78	138	90
	1	25	77	104	80	40	104	80	100	105	80	100	105	80	90	156	100
	1 1/4	32	85	127	90	47	127	90	113	127	90	113	127	90	105	184	115
	1 1/2	40	100	145	100	52	145	100	120	145	100	120	145	100	120	187	115
	2	50	119	174	115	61	174	115	145	174	115	145	174	115	145	212	135
	2 1/2	65	139	199	135	74	199	135	165	198	135	165	198	135	—	—	—
3	80	158	215	155	85	215	155	177	215	155	177	215	155	—	—	—	
4	100	—	—	—	—	—	—	—	220	250	180	220	250	180	—	—	—
BODY	Cast Bronze					Cast Bronze			Cast Bronze			Cast Bronze			Cast Bronze		
BONNET	Forged Brass / Cast Bronze					Forged Brass / Cast Bronze			Forged Brass / Cast Bronze			Forged Brass / Cast Bronze			Forged Brass / Cast Bronze		
STEM	Special Brass					Special Brass			Special Brass			Special Brass			Special Brass		
DISC	Cast Bronze					Cast Bronze			Cast Bronze			Cast Bronze			G/F PTFE		
									Fringed ends undrilled						Soft Seated disc		

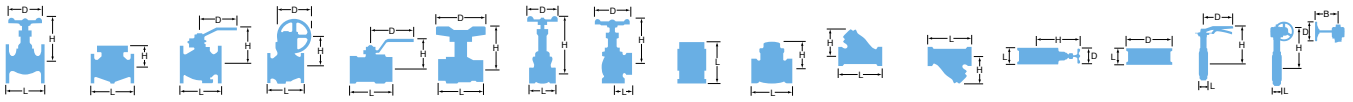
TYPE	GLOBE					GLOBE			GLOBE			GLOBE			GLOBE		
Bronze&Brass																	
FIG	DB					DBH			K			J			JB		
PRESSURE	Class 150					Class 150			5K			10K			10K		
END CONNECTION	JIS B2240					JIS B2240			BS21 (JIS B0203)			BS21 (JIS B0203)			JIS B2011		
DIMENSIONS	inch	mm	L	H	D	L	H	D	L	H	D	L	H	D	L	H	D
	1/4	8	—	—	—	—	—	—	—	—	—	50	86	50	—	—	—
	3/8	10	—	—	—	—	—	—	50	87	55	55	87	55	—	—	—
	1/2	15	82	113	60	82	113	60	60	90	60	65	93	60	85	93	60
	3/4	20	95	138	90	95	138	90	70	102	70	80	122	80	95	122	80
	1	25	108	156	100	108	156	100	80	112	80	90	135	90	110	135	90
	1 1/4	32	120	184	115	120	184	115	100	137	90	105	157	100	130	157	100
	1 1/2	40	140	187	115	140	187	115	110	142	100	120	171	115	150	171	115
	2	50	165	212	135	165	212	135	135	173	115	140	196	135	180	196	135
	2 1/2	65	190	244	155	190	244	155	160	203	135	180	232	155	210	232	155
3	80	220	281	180	220	281	180	190	233	155	200	268	180	240	268	180	
4	100	270	321	225	270	321	225	—	—	—	—	—	—	280	323	225	
BODY	Cast Bronze					Cast Bronze			Cast Bronze			Cast Bronze			Cast Bronze		
BONNET	Forged Brass / Cast Bronze					Forged Brass / Cast Bronze			Forged Brass / Cast Bronze			Forged Brass / Cast Bronze			Forged Brass / Cast Bronze		
STEM	Special Brass					Special Brass			Special Brass			Special Brass			Special Brass		
DISC	G/F PTFE					G/F PTFE			Cast Bronze/Cast Bronze			Cast Bronze			Cast Bronze		
	Soft Seated disc Fringed ends undrilled					Soft Seated disc											



Bronze & Brass
 Cast Iron
 Ductile Iron
 Stainless Steel
 Carbon Steel
 Butterfly Valve
 Ball Valve
 Actuated Valve

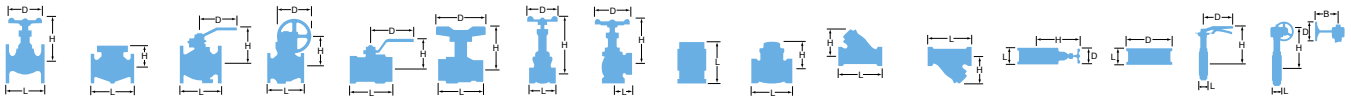
TYPE		GLOBE					GLOBE					GLOBE					GLOBE									
Bronze&Brass																										
FIG		300D					C150D					AKA					AKG					AKC				
PRESSURE		Class 300					Class 150					Class 100					Class 125					Class 150				
END CONNECTION		BS21 (JIS B0203)					ASME B16.18					ASME B1.20.1					ASME B1.20.1					ASME B1.20.1				
DIMENSIONS		inch	mm	L	H	D	L	H	D	L	H	D	L	H	D	L	H	D								
	1/4	8	53	113	60	58	109	60	40	66	50	47	68	50	44	66	50	50								
	3/8	10	55	113	60	61	109	60	42	67	50	53	88	55	44	68	50	50								
	1/2	15	64	126	80	72	116	70	48	69	55	57	100	60	53	79	60	60								
	3/4	20	78	139	90	95	136	90	53	80	60	66	110	70	65	93	70	70								
	1	25	90	157	100	112	149	100	63	94	70	76	120	80	77	104	80	80								
	1 1/4	32	105	187	115	126	173	115	73	104	80	88	140	90	85	127	90	90								
	1 1/2	40	120	192	135	145	182	115	81	127	90	100	156	100	100	145	100	100								
	2	50	145	221	155	180	209	135	94	147	100	120	185	115	119	174	115	115								
	2 1/2	65	-	-	-	205	247	155	115	179	115	147	210	135	139	199	135	135								
	3	80	-	-	-	244	275	180	131	200	135	162	229	155	158	215	155	155								
	4	100	-	-	-	312	298	225	171	250	180	-	-	-	-	-	-	-								
BODY		Cast Bronze					Cast Bronze					Cast Bronze					Cast Bronze									
BONNET		Cast Bronze					Cast Bronze					Forged Brass / Cast Bronze					Forged Brass / Cast Bronze									
STEM		Cast Bronze					Cast Bronze					Special Brass					Special Brass									
DISC		G/F PTFE					G/F PTFE					Cast Bronze					G/F PTFE									
		Soft Seated disc					Soft Seated disc Solder end joint										Soft Seated disc									

TYPE		GLOBE					GLOBE					GLOBE					GLOBE					GLOBE				
Bronze&Brass																										
FIG		AKCA					AK125C					AK150D					AK300D					AK300J				
PRESSURE		Class 150					Class 125					Class 150					Class 300					Class 300				
END CONNECTION		ASME B1.20.1					ASME B1.20.1					ASME B1.20.1					ASME B1.20.1					ASME B1.20.1				
DIMENSIONS		inch	mm	L	H	D	L	H	D	L	H	D	L	H	D	L	H	D								
	1/4	8	21	66	50	-	-	-	53	109	60	53	113	60	53	113	60	60								
	3/8	10	24	68	50	-	-	-	55	109	60	55	113	60	55	113	60	60								
	1/2	15	28	79	60	53	76	60	64	116	70	64	126	80	64	126	80	80								
	3/4	20	34	93	70	65	98	70	78	136	90	78	139	90	78	139	90	90								
	1	25	40	104	80	77	108	80	90	149	100	90	157	100	90	159	100	100								
	1 1/4	32	47	127	90	85	137	90	105	173	115	105	187	115	105	187	115	115								
	1 1/2	40	52	145	100	100	160	100	120	182	115	120	192	135	120	195	135	135								
	2	50	61	174	115	119	180	115	145	209	135	145	221	155	145	224	155	155								
	2 1/2	65	74	199	135	150	202	135	170	247	155	-	-	-	-	-	-	-								
	3	80	85	215	155	178	246	155	200	275	180	-	-	-	-	-	-	-								
	4	100	-	-	-	-	-	-	245	298	225	-	-	-	-	-	-	-								
BODY		Cast Bronze					Cast Bronze					Cast Bronze					Cast Bronze									
BONNET		Forged Brass / Cast Bronze					Forged Brass / Cast Bronze					Cast Bronze					Cast Bronze									
STEM		Special Brass					Cast Bronze					Cast Bronze					Cast Bronze									
DISC		Cast Bronze					Cast Bronze					G/F PTFE					G/F PTFE									
												Soft Seated disc					Soft Seated disc									



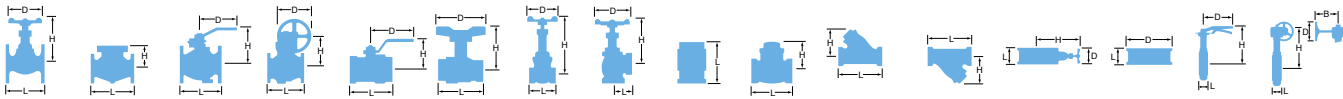
TYPE	GLOBE			GLOBE			LIFT CHECK			SWING CHECK			SWING CHECK				
BRONZE&BRASS																	
FIG	PN16A			PN25A			F			R			O				
PRESSURE	PN16			PN25			Class 150			Class 125			10K				
END CONNECTION	BS21 (JIS B0203)			BS21 (JIS B0203)			BS21 (JIS B0203)			BS21 (JIS B0203)			JIS B0203				
DIMENSIONS	inch	mm	L	H	D	L	H	D	L	H	D	L	H	D	L	H	D
	3/8	10	-	-	-	-	-	-	44	26	-	53	39	-	55	38.5	-
	1/2	15	48	69	55	48	69	55	53	28	-	60	39	-	65	43	-
	3/4	20	53	80	60	53	80	60	65	34	-	70	45	-	80	51.5	-
	1	25	63	94	70	63	94	70	77	42	-	80	52	-	90	58.5	-
	1 1/4	32	73	104	80	73	104	80	85	50	-	92	62	-	105	67	-
	1 1/2	40	81	127	90	81	127	90	100	56	-	102	67	-	120	73.5	-
	2	50	94	147	100	94	147	100	119	67	-	122	79	-	140	86	-
	2 1/2	65	-	-	-	-	-	-	139	79	-	150	91	-	180	97	-
	3	80	-	-	-	-	-	-	158	91	-	165	102	-	200	108	-
4	100	-	-	-	-	-	-	-	-	-	195	119	-	-	-	-	
BODY	Cast Bronze			Cast Bronze			Cast Bronze			Cast Bronze			Cast Bronze				
BONNET	Forged Brass			Forged Brass			-			-			-				
CAP	-			-			Forged Brass / Cast Bronze			Forged Brass / Cast Bronze			Forged Brass				
STEM	Special Brass			Special Brass			-			-			-				
HINGE PIN	-			-			-			Brass			Brass Rod				
DISC	Cast Bronze			Cast Bronze			Cast Bronze			Forged Brass / Cast Bronze			Cast Bronze				

TYPE	SWING CHECK			SWING CHECK			WAFER CHECK			LIFT CHECK			LIFT CHECK				
BRONZE&BRASS																	
FIG	OB			YR			10BWZ			RF			VF				
PRESSURE	10K			Class 125			10K			10K			-				
END CONNECTION	JIS B2240			BS21 (JIS B0203)			Wafer Type			BS21 (JIS B0203)			BS21 (JIS B0203)				
DIMENSIONS	inch	mm	L	H	D	L	H	D	L	H	D	L	H	D	L	H	D
	3/8	10	-	-	-	54	40	-	-	-	-	-	-	-	-	-	-
	1/2	15	85	43	-	56	40	-	-	-	-	53	-	-	37	-	-
	3/4	20	95	52	-	70	49	-	-	-	-	59	-	-	44	-	-
	1	25	110	59	-	80	58	-	-	-	-	67	-	-	51	-	-
	1 1/4	32	130	67	-	95	71	-	-	-	-	78	-	-	62	-	-
	1 1/2	40	150	74	-	110	80	-	54	132	55	84	-	-	69	-	-
	2	50	180	86	-	128	95	-	56	139	70	98	-	-	82	-	-
	2 1/2	65	210	97	-	-	-	-	56	146	70	-	-	-	-	-	-
	3	80	240	108	-	-	-	-	59	152	70	-	-	-	-	-	-
	4	100	280	127	-	-	-	-	66	165	70	-	-	-	-	-	-
	5	125	-	-	-	-	-	-	72	183	70	-	-	-	-	-	-
	6	150	-	-	-	-	-	-	78	208	80	-	-	-	-	-	-
8	200	-	-	-	-	-	-	96	237	80	-	-	-	-	-	-	
10	250	-	-	-	-	-	-	109	289	90	-	-	-	-	-	-	
12	300	-	-	-	-	-	-	145	316	90	-	-	-	-	-	-	
BODY	Cast Bronze			Cast Bronze			Cast Bronze+NBR			Cast Bronze			Cast Bronze				
CAP	Forged Brass / Cast Bronze			Forged Brass			-			Cast Bronze			Forged Brass / Cast Bronze				
HINGE PIN	Brass			Copper			SUS304			-			-				
DISC	Cast Bronze			Cast Bronze			Cast Bronze / Brass			NBR			Special Brass/Cast Bronze				
										Soft Seated disc							



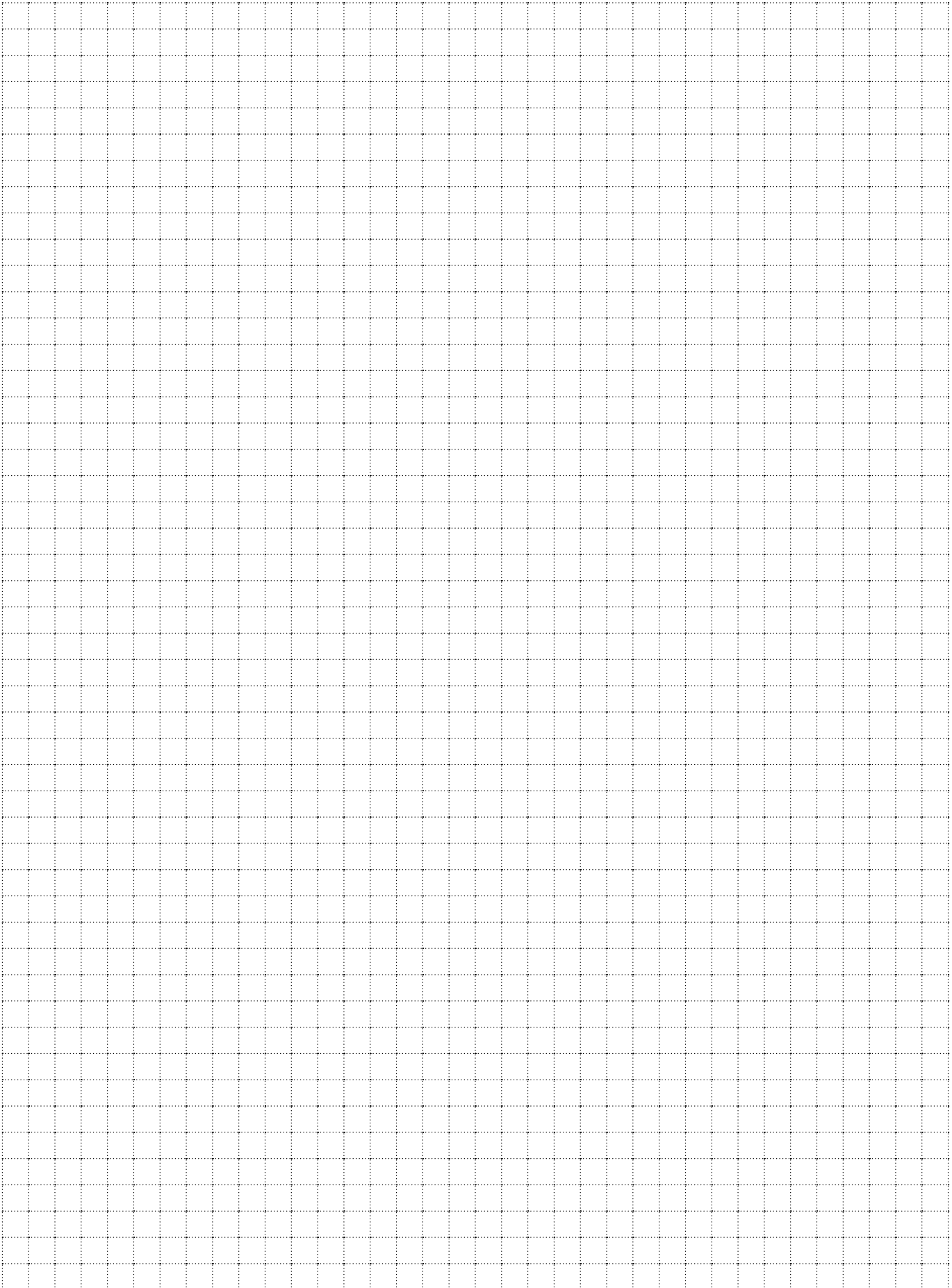
TYPE	FOOT CHECK			FOOT CHECK			SWING CHECK			SWING CHECK			LIFT CHECK				
Bronze&Brass																	
FIG	FT			FTS			150YR			CYR			CAF				
PRESSURE	-			-			Class 150			Class 125			Class 150				
END CONNECTION	BS21 (JIS B0203)			BS21 (JIS B0203)			BS21 (JIS B0203)			ASME B16.18			ASME B16.18				
DIMENSIONS	inch	mm	L	H	D	L	H	D	L	H	D	L	H	D	L	H	D
	3/8	10	-	-	-	-	-	-	54	39	-	-	-	-	-	-	-
	1/2	15	-	-	-	-	-	-	60	39	-	67	38	-	61	-	-
	3/4	20	-	48	-	-	25	-	72	49	-	86	47	-	76	-	-
	1	25	-	58	-	-	29	-	84	58	-	105	56	-	89	-	-
	1 1/4	32	-	62	-	-	32	-	99	70	-	121	69	-	97	-	-
	1 1/2	40	-	70	-	-	35	-	113	79	-	137	77	-	110	-	-
	2	50	-	80	-	-	43	-	131	95	-	170	92	-	132	-	-
	2 1/2	65	-	90	-	-	50	-	-	-	-	194	111	-	-	-	-
3	80	-	100	-	-	51	-	-	-	-	222	127	-	-	-	-	
BODY	Cast Bronze			Cast Bronze			Cast Bronze			Cast Bronze			Cast Bronze				
CAP	Cast Bronze			-			Forged Brass			Forged Brass			Cast Bronze				
HINGE PIN	-			-			Copper			Copper			-				
DISC	NBR			-			Cast Bronze			Cast Bronze			FKM				
	Soft Seated disc									Solder end joint			Solder end joint Soft Seated disc				

TYPE	SWING CHECK			SWING CHECK			SWING CHECK			LIFT CHECK			SWING CHECK				
Bronze&Brass																	
FIG	AKYR			AK150YR			AK300YR			AKAF			PN16R				
PRESSURE	Class 125			Class 150			Class 300			Class 150			PN16				
END CONNECTION	ASME B1.20.1			ASME B1.20.1			ASME B1.20.1			ASME B1.20.1			BS21 (JIS B0203)				
DIMENSIONS	inch	mm	L	tH	D	L	H	D	L	H	D	L	H	D	L	H	D
	3/8	10	-	-	-	54	39	-	-	-	-	-	-	-	-	-	-
	1/2	15	56	40	-	60	39	-	60	42	-	53	-	-	60	39	-
	3/4	20	70	49	-	72	49	-	72	51	-	59	-	-	70	45	-
	1	25	80	58	-	84	58	-	84	61	-	67	-	-	80	52	-
	1 1/4	32	95	71	-	99	70	-	99	74	-	78	-	-	92	62	-
	1 1/2	40	110	80	-	113	79	-	113	83	-	84	-	-	102	67	-
	2	50	128	95	-	131	95	-	131	98	-	98	-	-	122	79	-
	2 1/2	65	156	114	-	162	114	-	-	-	-	-	-	-	-	-	-
3	80	184	131	-	186	132	-	-	-	-	-	-	-	-	-	-	
BODY	Cast Bronze			Cast Bronze			Cast Bronze			Cast Bronze			Cast Bronze				
CAP	Forged Brass			Forged Brass			Cast Bronze			Cast Bronze			Forged Brass				
HINGE PIN	Copper			Copper			Copper			-			Forged Brass				
DISC	Cast Bronze			Cast Bronze			Cast Bronze			FKM			Forged Brass				
										Soft Seated disc							



TYPE	SWING CHECK					Y TYPE STRAINER			Y TYPE STRAINER			Y TYPE STRAINER			Y TYPE STRAINER		
Bronze&Brass																	
FIG	PN25R					Y			CY			AKY			PN16YE		
PRESSURE	PN25					10K			10K			Class 150			PN16		
END CONNECTION	BS21 (JIS B0203)					BS21 (JIS B0203)			JIS B2011			ASME B1.20.1			BS21 (JIS B0203)		
DIMENSIONS	inch	mm	L	H	D	L	H	D	L	H	D	L	H	D	L	H	D
	3/8	10	-	-	-	70	44	-	-	-	-	70	44	-	-	-	-
	1/2	15	53	39	-	80	49	-	80	49	-	80	49	-	65	42	-
	3/4	20	61	45	-	100	57	-	105	57	-	100	57	-	80	52	-
	1	25	70	50	-	115	70	-	125	70	-	115	70	-	92	60	-
	1 1/4	32	81	58	-	135	82	-	145	82	-	135	82	-	110	72	-
	1 1/2	40	91	65	-	160	98	-	170	98	-	160	98	-	122	81	-
	2	50	109	75	-	195	121	-	210	121	-	195	121	-	150	101	-
	2 1/2	65	-	-	-	230	150	-	250	150	-	-	-	-	-	-	-
	3	80	-	-	-	240	183	-	280	183	-	-	-	-	-	-	-
BODY	Cast Bronze					Cast Bronze			Cast Bronze			Cast Bronze			Cast Bronze		
CAP	Forged Brass					Forged Brass			Forged Brass			Forged Brass			Forged Brass		
HINGE PIN	Brass Rod					-			-			-			-		
DISC	Forged Brass					-			-			-			-		
SCREEN	-					304SS			304SS			Stainless Steel			Stainless Steel		
									Solder end joint								

TYPE	Y TYPE STRAINER				
Bronze&Brass					
FIG	PN25YE				
PRESSURE	PN25				
END CONNECTION	BS21 (JIS B0203)				
DIMENSIONS	inch	mm	L	H	D
	1/2	15	65	42	-
	3/4	20	80	52	-
	1	25	92	60	-
	1 1/4	32	110	72	-
	1 1/2	40	122	81	-
	2	50	150	101	-
BODY	Cast Bronze				
CAP	Forged Brass				
SCREEN	Stainless Steel				



CAST IRON

Cast Iron

Basic Design Specifications

Class	JIS5K/10K	Class 100/125
Face to face dimension	JIS B2031	ASME B16.10
End flange dimension		ASME B16.1
Wall thickness		KITZ Std.

*Please refer to our website (www.kitz.co.jp) or contact KITZ for details.

Material Specifications for Grey Iron Casting

JIS materials	FC200	FC250	FC300
	Mechanical properties		
Tensile strength (N/mm ²) min.	200	250	300
Brinell hardness (HB) max.	223	241	262
ASTM A126 Class B	Tensile strength (min)		31ksi
Transverse test requirement	Face at center, min.		3,300 lb
	Deflection at center, min.		0.12 in

ASME Valves Pressure-Temperature Ratings

Maximum Allowable Non-Shock Pressure

Service temperature		Class 125				
		Size 2" to 12"		Size 14" to 24"		
°F	°C	Psi.	MPa	Psi.	MPa	
-20 to 150	-29 to 66	200	1.37	150	1.03	
200	93	190	1.30	135	0.93	
225	107	180	1.24	130	0.89	
250	121	175	1.20	125	0.86	
275	135	170	1.17	120	0.82	
300	149	165	1.13	110	0.75	
325	163	155	1.06	105	0.72	
350	177	150	1.03	100	0.69	
375	191	145	1.00			
400	204	140	0.96			
425	218	130	0.89			
450	232	125	0.86			
Saturated steam		125	0.86	100	0.69	
Test pressure	Hydro-static	Shell	350	2.41	265	1.83
		Seat	220	1.51	165	1.13
	Air	Seat	80	0.59	80	0.59

Remarks:

- All pressures are given in pounds per square inch gage (PSIG).
- Pressure-temperature ratings extracted from MSS SP-70, 71, 85 apply to iron flanged end valves designed for primary working pressures in Class 125.

Conditions of Fluids and Maximum Permissible Pressures

Standards		5 K	10 K				10 K	
Nominal pressure		JIS B2031	JIS B2031				KITZ standard	
Valve type		Outside screw gate valve	Outside screw gate valve	Glove valve, Swing check valve		Inside screw gate valve	Valve 350 A or more	FC300 valve
Disc seat structure		Press-fit seat	Screw seat	Screw seat		Press-fit seat	Screw seat	Press-fit seat
Main section		CAC406	CAC 406 13 chrome 18-8 stainless steel	CAC 406	13 chrome 18-8 stainless steel	CAC 406	CAC 406 13 chrome 18-8 stainless steel	CAC 406 13 chrome
Maximum permissible working pressure	Steady flow below 120 degrees in centigrade	0.7	1.4	1.4	—	1.4	1.0	1.0
	Oil, pulsating flow and water below 120 degrees in centigrade	0.5	1.0	1.0	—	1.0	0.9	0.9
	Saturated steam*1	0.2	0.7	0.7	—	0.2	0.7	0.7
	Gas below 120 degrees in centigrade	0.2	0.2	0.2	—	0.2	0.2	0.2
	120 degrees in centigrade	—	—	—	1.4	—	—	—
	220 degrees in centigrade	—	—	—	1.0	—	—	—

*1 When the main section is made of 18-8 stainless steel and used for steam piping, it is necessary to weld hardened metal cladding on the seat surface.

Please designate the same together with the steam specification.

When it is used for saturated steam at a pressure of 0.5 MPa or more, please designate accordingly.

*2 Such gases as set forth in the High Pressure Gas Safety Act shall be excluded.

Gases—Gases other than flammable and toxic gases

PN Series Valves Pressure-Temperature Ratings

Maximum permissible working pressure (bar)

Service temperature (°C)	Cast iron valves
	PN16
-10 to 66	16
100	
120	
150	
170	
180	
186	
198	
200	
200	

(Note) : Intermediate values may be obtained by linear interpolation.

Simplified Material Indication (as referred to in each page)

Bronze trim : Iron body with bronze trim

13 Cr. trim : Iron body with 13 Cr. trim

18-8 trim : Iron body with 18 Cr.-8 Ni trim

Certification by JIS Mark

The Industrial Standardization Law of Japan provides an effective measure to promote the introduction of a high-level quality assurance system of manufacture and processing. KITZ valves that are identified with the JIS Mark are officially certified as being produced under strict quality assurance procedures and practices to satisfy the designated quality level stably and constantly.

Valve Position Indicators



A valve position indicator is provided on gate valves with an inside screw design as illustrated here. Opening or closing the valves does not move the vertical position of the handwheel. Instead, the position indicator visually indicates three valve operating positions: fully opened, fully closed, or half opened.

Trim Materials

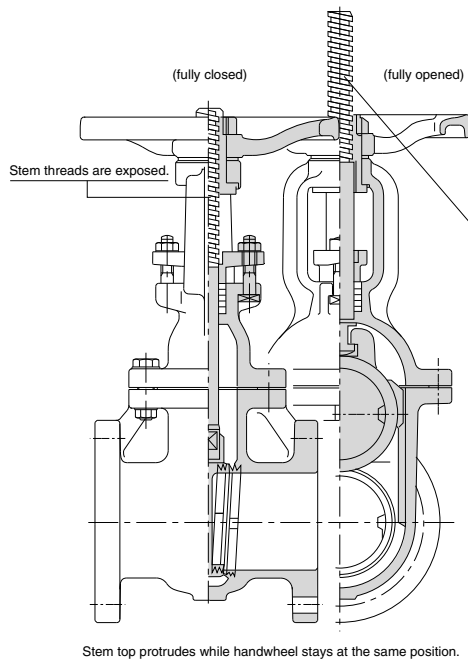
KITZ cast iron valves are provided with any one of the three trim materials listed below for versatility of service applications.

Color coding is made on a spoke of the handwheel of the gate or globe valves and on the cover of swing check valves.

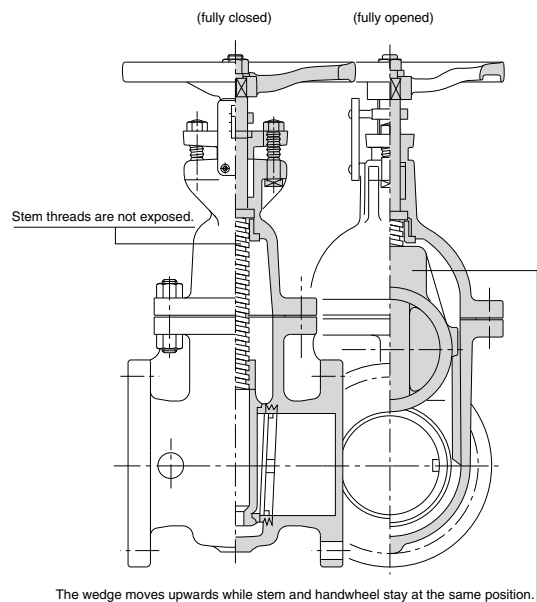
Trim material	Color coding	Suffix of Fig.
■ Bronze seats / Brass stem	None	—
■ 13 Cr. seats / stem	Yellow	S
■ 18-8 seats / stem	Red	U

Outside Screw (O.S.) Valves and Inside Screw (I.S.) Valves

Outside Screw Gate Valve



Inside Screw Gate Valve



Outside Screw Gate Valves

The stem threads are exposed to air, and the valve opening operation moves the stem upward while the handwheel stays at the same position. The valve operating position can be visually known by observing the stem travel. KITZ Figs. FCM, FCL, FCLS and FCLU are designed this way.

Outside Screw Globe Valves

The stem and handwheel move upward or downward simultaneously, following the valve opening or closing operation. All KITZ globe valves have this design.

Inside Screw Gate Valves

The stem threads are not exposed to air and the valve opening operation does not cause movement of the stem or handwheel, and so, the valve operating position is not visible. A position indicator is provided for this reason. Inside screw gate valves are generally designed to be shorter than outside screw gate valves and the stem and handwheels always stay at the same position. On account of this feature, inside screw gate valves are widely employed for underground installation or for service in narrow areas with limited room. KITZ Figs. FCWI and FCHI are designed this way.

Asbestos-free Packings and Gaskets

KITZ has led the industry in employing asbestos-free sealers for all cast iron valves, meeting the requirement of pollution-free valve materials. PTFE-impregnated glass fiber gland packings and compressed glass and aramid fiber gaskets are the standard sealers for KITZ cast iron valves.

Product Coding

125 FC L S

① ② ③ ④

① Valve class

100 Class 100
125 Class 125
5 JIS 5K
10 JIS 10K
EN16 PN16

② Symbol of shell material

FC Cast Iron

③ Type of valve

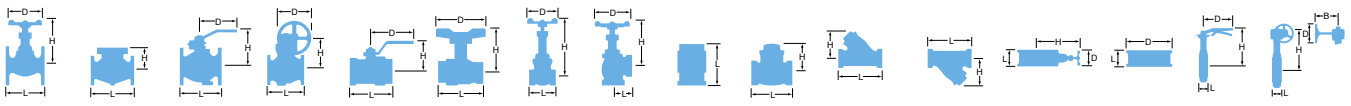
L Gate valve
WI & HI ... Gate valve with indicator
J Globe valve
O Check valve
TB Full port ball valve
TR Reduced port ball valve

④ Trim material

None ... Bronze trim
U Type 304 stainless steel
S Type 403 stainless steel
M Type 316 stainless steel

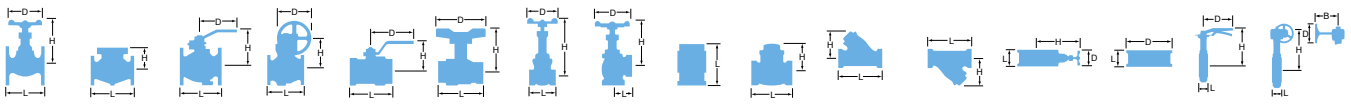
NOTE

B.B. Bolted bonnet I.S. Inside screw
O.S.&Y ... Outside screw & yoke N.R.S. Non-rising stem



TYPE	GATE						GATE			GATE			GATE			GATE		
Cast Iron																		
FIG	10FCHI						10FCL			10FCLS			125FCHI			125FCL		
PRESSURE	10K						10K			10K			Class 125			Class 125		
END CONNECTION	JIS B2239						JIS B2239			JIS B2239			ASME B16.1			ASME B16.1		
DIMENSIONS	inch	mm	L	H	D	L	H	D	L	H	D	L	H	D	L	H	D	
	1½	40	140	210	140	165	306	160	165	306	160	140	210	140	—	—	—	
	2	50	146	250	140	180	343	170	180	343	170	146	250	140	178	328	160	
	2½	65	159	285	160	190	389	170	190	389	170	159	285	160	190	382	170	
	3	80	165	350	160	200	462	200	200	462	200	165	350	160	203	436	170	
	4	100	171	400	180	230	547	250	230	547	250	171	400	180	229	532	225	
	5	125	190	460	225	250	648	280	250	648	280	190	465	225	254	627	225	
	6	150	210	515	225	270	759	300	270	759	300	210	515	225	267	726	250	
	8	200	241	635	300	290	956	350	290	956	350	241	630	300	292	919	280	
	10	250	273	760	350	330	1168	400	330	1168	400	—	—	—	330	1134	350	
	12	300	305	870	350	350	1363	450	350	1363	450	—	—	—	356	1363	450	
	14	350	—	—	—	381	1560	500	381	1560	500	—	—	—	381	1560	500	
	16	400	—	—	—	—	—	—	406	1795	600	—	—	—	—	—	—	
	18	450	—	—	—	—	—	—	432	1995	600	—	—	—	—	—	—	
	20	500	—	—	—	—	—	—	457	2230	680	—	—	—	—	—	—	
	22	550	—	—	—	—	—	—	508	2640	760	—	—	—	—	—	—	
BODY	Cast Iron						Cast Iron			Cast Iron			Cast Iron			Cast Iron		
BONNET	Cast Iron						Cast Iron			Cast Iron			Cast Iron			Cast Iron		
STEM	Forged Brass						Forged Brass			Stainless Steel			Forged Brass			Forged Brass		
DISC	Cast Bronze / Cast Iron						Cast Iron			Cast Iron			Cast Bronze / Cast Iron			Cast Iron		
SEAT	Cast Bronze						Cast Bronze			Stainless Steel			Cast Bronze			Cast Bronze		

TYPE	GATE						GATE			GLOBE			GLOBE			GLOBE		
Cast Iron																		
FIG	125FCLS						125FCWI			10FCJ			10FCJS			125FCJ		
PRESSURE	Class 125						Class 125			10K			10K			Class 125		
END CONNECTION	ASME B16.1						ASME B16.1			JIS B2239			JIS B2239			ASME B16.1		
DIMENSIONS	inch	mm	L	H	D	L	H	D	L	H	D	L	H	D	L	H	D	
	1½	40	—	—	—	—	—	—	190	260	160	190	260	160	—	—	—	
	2	50	178	328	160	178	250	140	200	277	180	200	277	180	203	277	180	
	2½	65	190	382	170	190	285	160	220	307	180	220	307	180	216	307	180	
	3	80	203	436	170	203	350	160	240	353	225	240	353	225	241	353	225	
	4	100	229	532	225	229	400	180	290	404	280	290	404	280	292	404	280	
	5	125	254	627	225	254	465	225	360	467	300	360	467	300	330	467	300	
	6	150	267	726	250	267	515	225	410	533	350	410	533	350	356	533	350	
	8	200	292	919	280	292	630	300	500	620	450	500	620	450	495	620	450	
	10	250	330	1134	350	330	760	350	—	—	—	620	665	450	—	—	—	
	12	300	356	1363	450	356	870	350	—	—	—	700	755	500	—	—	—	
	14	350	381	1560	500	—	—	—	—	—	—	—	—	—	—	—	—	
BODY	Cast Iron						Cast Iron			Cast Iron			Cast Iron			Cast Iron		
BONNET	Cast Iron						Cast Iron			Cast Iron			Cast Iron			Cast Iron		
STEM	Stainless Steel						Forged Brass			Forged Brass			Stainless Steel			Forged Brass		
DISC	Cast Iron						Cast Iron			Cast Bronze / Cast Iron			Cast Iron / Stainless Steel			Cast Bronze / Cast Iron		



TYPE		GLOBE				SWING CHECK			SWING CHECK			SWING CHECK			WAFER CHECK			
Cast Iron																		
FIG		125FCJS				10FCO			10FCOC			125FCO			10FWZ			
PRESSURE		Class 125				10K			10K			Class 125			10K			
END CONNECTION		ASME B16.1				JIS B2239			JIS B2239			ASME B16.1			Wafer Type			
DIMENSIONS		inch	mm	L	H	D	L	H	D	L	H	D	L	H	D	L	H	D
	1 1/2	40	—	—	—	—	190	106	—	—	—	—	—	—	—	54	128	55
	2	50	203	277	180	200	111	—	—	200	116	—	203	111	—	56	143	70
	2 1/2	65	216	307	180	220	121	—	—	220	126	—	216	121	—	56	150	70
	3	80	241	353	225	240	145	—	—	240	153	—	241	145	—	59	156	70
	4	100	292	404	280	290	165	—	—	290	170	—	292	165	—	66	169	70
	5	125	330	467	300	360	207	—	—	360	217	—	330	207	—	72	183	70
	6	150	356	533	350	410	225	—	—	410	235	—	356	225	—	78	216	80
	8	200	495	620	450	500	268	—	—	500	273	—	495	268	—	96	243	80
	10	250	—	—	—	620	315	—	—	—	—	—	622	315	—	109	290	90
	12	300	—	—	—	700	356	—	—	—	—	—	—	—	—	145	315	90
	14	350	—	—	—	—	—	—	—	—	—	—	—	—	—	184	330	90
	16	400	—	—	—	—	—	—	—	—	—	—	—	—	—	191	355	90
	18	450	—	—	—	—	—	—	—	—	—	—	—	—	—	204	388	90
BODY		Cast Iron				Cast Iron			Cast Iron			Cast Iron			Cast Iron+NBR			
BONNET		Cast Iron				—			—			—			Cast Bronze / Forged Brass			
COVER		—				Cast Iron			Cast Iron			Cast Iron			—			
STEM		Stainless Steel				—			—			—			Brass			
HINGE PIN		—				Forged Brass			Forged Brass			Forged Brass			Stainless Steel / Brass			
DISC		Cast Iron / Stainless Steel				Cast Bronze / Cast Iron			Cast Bronze			Cast Bronze / Cast Iron			Cast Bronze			

TYPE		WAFER CHECK				WAFER CHECK			WAFER CHECK			WAFER CHECK			
Cast Iron															
FIG		125FWNB				125FWNBE			PN16FWNB			PN16FWNBME			
PRESSURE		Class 125				125FWNBE			PN16			PN16			
END CONNECTION		Wafer Type				Wafer Type			Wafer Type			Wafer Type			
DIMENSIONS		inch	mm	L	H	D	L	H	D	L	H	D	L	H	D
	2	50	54	—	105	54	—	105	—	—	—	—	—	—	—
	2 1/2	65	54	—	124	54	—	124	—	—	—	—	—	—	—
	3	80	57	—	137	57	—	137	—	—	—	—	—	—	—
	4	100	64	—	175	64	—	175	—	—	—	—	—	—	—
	5	125	70	—	197	70	—	197	—	—	—	—	—	—	—
	6	150	76	—	222	76	—	222	—	—	—	—	—	—	—
	8	200	95	—	279	95	—	279	—	—	—	—	—	—	—
	10	250	108	—	340	108	—	340	—	—	—	—	—	—	—
	12	300	143	—	410	143	—	410	—	—	—	—	—	—	—
	14	350	—	—	—	—	—	—	184	—	446	184	—	446	—
	16	400	—	—	—	—	—	—	191	—	498	191	—	498	—
	18	450	—	—	—	—	—	—	203	—	558	203	—	558	—
	20	500	—	—	—	—	—	—	213	—	620	213	—	620	—
	24	600	—	—	—	—	—	—	222	—	737	222	—	737	—
BODY		Cast Iron				Cast Iron			Cast Iron			Cast Iron			
HINGE PIN		Stainless Steel				Stainless Steel			Stainless Steel			Stainless Steel			
DISC		Bronze				Bronze			Stainless Steel			Stainless Steel			
SEAT		NBR				EPDM			NBR			EPDM			

Bronze & Brass

Cast Iron

Ductile Iron

Stainless Steel

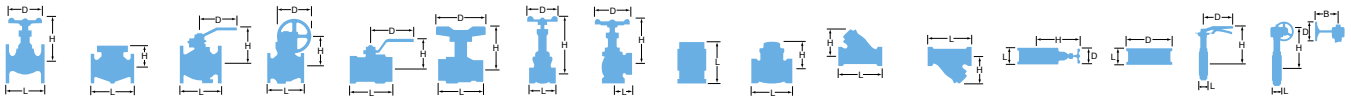
Carbon Steel

Butterfly Valve

Ball Valve

Ball Valve Seat

Actuated Valve



TYPE		Y TYPE STRAINER				Y TYPE STRAINER			
Cast Iron									
FIG		10FCY				125FCY			
PRESSURE		10K				Class 125			
END CONNECTION		JIS B2239				ASME B16.1			
DIMENSIONS	inch	mm	L	H	D	L	H	D	
	3/8	10	115	46	-	-	-	-	
	1/2	15	125	57	-	-	-	-	
	3/4	20	140	63	-	-	-	-	
	1	25	150	77	-	-	-	-	
	1 1/4	32	170	90	-	-	-	-	
	1 1/2	40	190	100	-	-	-	-	
	2	50	230	138	-	250	168	-	
	2 1/2	65	305	208	-	285	212	-	
	3	80	360	237	-	315	242	-	
	4	100	415	280	-	370	284	-	
	5	125	465	325	-	420	325	-	
	6	150	515	370	-	490	370	-	
	8	200	580	457	-	570	440	-	
	10	250	680	536	-	680	515	-	
	12	300	800	625	-	800	600	-	
	14	350	950	741	-	950	740	-	
BODY		Cast Iron				Cast Iron			
COVER		Forged Brass / Cast Iron				Cast Iron			
SCREEN		304SS				304SS			

DUCTILE IRON

What is Ductile Iron ?

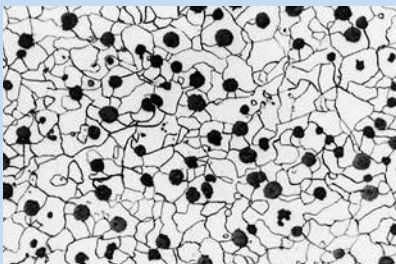
Gray iron, ductile iron, and malleable iron are the three kinds of iron used for valve construction. Unlike gray iron, which has thin, flake-like molecular formations, the metallic structures of both ductile and malleable iron contain nodular graphite. (Refer to the microscopic views shown here.) Ductile and malleable iron have superior mechanical properties compared to gray iron. They have properties almost equivalent to cast steel, which is an expensive material for industrial valves. Furthermore, their superior casting characteristics and ease of machining help to increase their suitability as a valve material.

Ductile iron outperforms malleable iron owing to its better mechanical characteristics for building the valve body, which is a kind of pressure-containing device. For example, ductile iron has a 20% higher tensile strength and 70% to 80% better elongation than malleable iron. This difference is attributed to the different formation processes of nodulated graphite molecules.

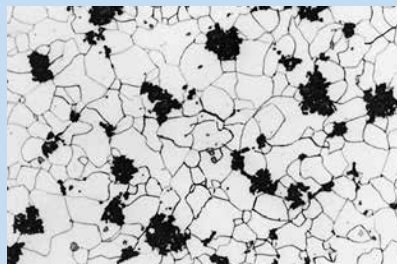
KITZ ductile iron valves are made of JIS FCD-S or ASTM A395 ductile iron. The history of the introduction of ductile iron valves on the market is rather short; however, their demand is steadily increasing owing to their economic advantage as well as the fact that their wide range of service applications is comparable to that of cast steel valves.

This catalog serves to provide the design specifications, construction materials, and external dimensions of the following ductile iron valves and strainers manufactured by KITZ Corporation :

- JIS 10K, 16K, and 20K Gate, Globe, and Check Valves
- JIS 10K and 20K Ball Valves
- JIS 10K, 16K, and 20K Strainers
- ASME 150 and 300 Gate, Globe, and Check Valves



Ductile iron



Malleable iron



Gray iron

Service Recommendation

For achieving higher mechanical shock resistance under high or low temperature and for achieving better tensile strength and elongation characteristics than those of ordinary gray iron valves, the use of ductile iron valves is highly recommended for the following services, sometimes, in place of cast:

- Piping for steam supply
- Air-conditioning and heating systems
- High-pressure gaseous service in general
- Piping for poisonous gas service

The range of high-pressure gaseous service for iron valves is specified by the Ministry of Economy, Trade and Industry of Japan as follows :

Valve material	Poisonous gas*	Inflammable gas	Other gas
Ductile iron (JIS FCD-S)		2.4 MPa maximum -5°C to + 350°C	
Ductile iron (JIS FCD400)	not recommended	1.6 MPa maximum 0°C to + 250°C	
Gray iron (JIS FC200)		not recommended	0.2 MPa maximum 0°C to + 250°C

*Phosgene and hydrogen cyanide are excluded.

Material Specifications of JIS FCD-S

1. Chemical composites:

Carbon : 3.00% minimum
 Phosphor : 0.08% maximum
 Silicon : 2.50% maximum; however, 0.08% may be added for every decrease of 0.01% phosphor within the total maximum of 2.75%

2. Mechanical properties:

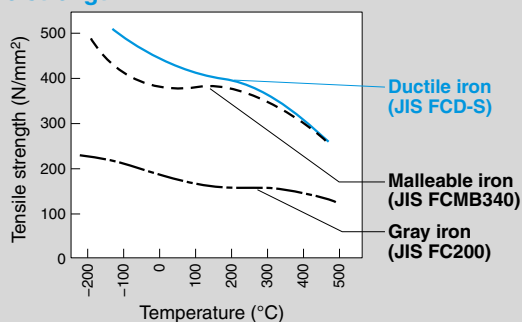
Tensile strength : 412 N/mm² (42 kgf/mm²) minimum
 Yield strength : 275 N/mm² (28 kgf/mm²) minimum
 Elongation : 18% minimum
 Brinell hardness : 143 to 187

Charpy impact value:

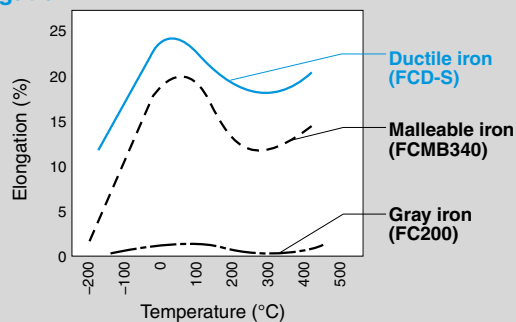
- for ambient temperature service;
 17 N-m/cm² (1.7 kgf-m/cm²) minimum in an average of three test pieces.
 15 N-m/cm² (1.5 kgf-m/cm²) minimum for the lowest impact value.
- for -10°C or lower temperature service;
 15.3 N-m/cm² (1.53 kgf-m/cm²) minimum in an average of three test pieces.
 13.3 N-m/cm² (1.33 kgf-m/cm²) minimum for the lowest impact value.

Compared Mechanical Properties of JIS Materials

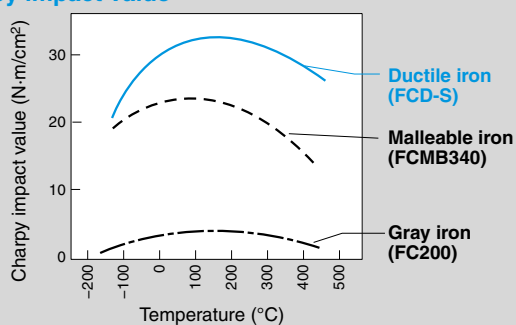
Tensile strength



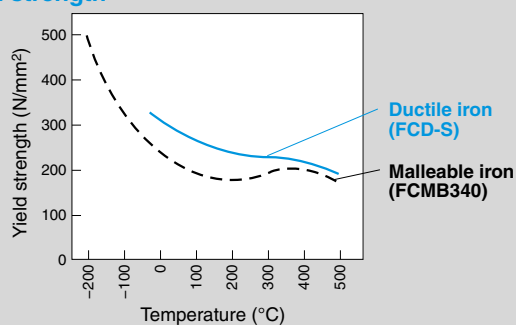
Elongation



Charpy impact value

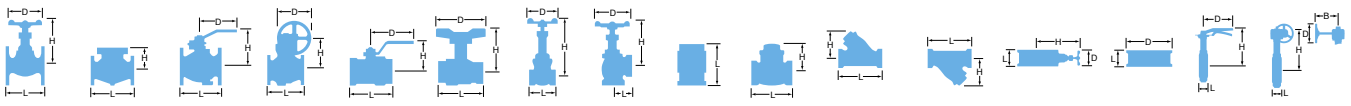


Yield strength



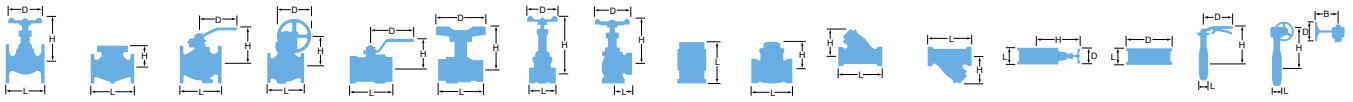
Design Specifications (Please refer to our website (www.kitz.co.jp) or contact KITZ for details.)

Class	JIS 10K/16K/20K	ASME 150/300
Face to face dimension	JIS B 2011, B 2002, or KITZ Std.	ASME B16. 10
End to end dimension	JIS B 2051 or KITZ Std.	—
End flange dimension	JIS B 2239	ASME B16. 5
End thread dimension	JIS B 0203	—
Shell wall thickness	KITZ standard, unless otherwise indicated on the following pages	



TYPE		GATE				GATE				GATE				GATE				GATE			
Ductile Iron																					
FIG		10SMS				10SMBF				10SMBOF				16SMB				16SMBO			
PRESSURE		10K				10K				10K				16K				16K			
END CONNECTION		BS21 (JIS B0203)				JIS B2239				JIS B2239				JIS B2239				JIS B2239			
DIMENSIONS	inch	mm	L	H	D	L	H	D	L	H	D	L	H	D	L	H	D				
	1/2	15	60	150	60	90	164	70	-	-	-	108	163	70	-	-	-				
	3/4	20	70	171	70	100	165	70	-	-	-	117	164	70	-	-	-				
	1	25	75	198	80	110	188	80	-	-	-	127	187	80	-	-	-				
	1 1/4	32	85	233	90	120	219	90	-	-	-	140	219	90	-	-	-				
	1 1/2	40	95	274	100	130	253	100	165	300	160	165	253	100	165	300	160				
	2	50	105	318	115	140	285	115	178	352	200	178	285	115	178	352	200				
	2 1/2	65	-	-	-	-	-	-	190	410	200	-	-	-	190	410	200				
	3	80	-	-	-	-	-	-	203	479	250	-	-	-	203	479	250				
	4	100	-	-	-	-	-	-	229	566	250	-	-	-	229	566	250				
	5	125	-	-	-	-	-	-	254	667	300	-	-	-	254	667	300				
	6	150	-	-	-	-	-	-	267	779	300	-	-	-	267	779	300				
	8	200	-	-	-	-	-	-	292	969	350	-	-	-	292	969	350				
	10	250	-	-	-	-	-	-	330	1181	400	-	-	-	330	1181	400				
	12	300	-	-	-	-	-	-	356	1404	450	-	-	-	356	1404	450				
	14	350	-	-	-	-	-	-	381	1538	500	-	-	-	-	-	-				
	16	400	-	-	-	-	-	-	406	1702	600	-	-	-	-	-	-				
	18	450	-	-	-	-	-	-	432	1538	500	-	-	-	-	-	-				
	20	500	-	-	-	-	-	-	457	1702	600	-	-	-	-	-	-				
BODY		Ductile Iron				Ductile Iron				Ductile Iron				Ductile Iron				Ductile Iron			
BONNET		Ductile Iron				Ductile Iron				Ductile Iron				Ductile Iron				Ductile Iron			
STEM		Stainless Steel				Stainless Steel				Stainless Steel				Stainless Steel				Stainless Steel			
DISC		Stainless Steel				Stainless Steel				Stainless Steel / Carbon Steel / Cast Steel				Stainless Steel				Stainless Steel / Carbon Steel / Cast Steel			

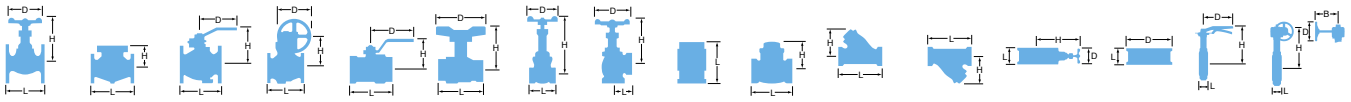
TYPE		GATE				GATE				GATE				GLOBE				GLOBE			
Ductile Iron																					
FIG		16SMS				20SLS				150SMBO				10SJ				10SJBF			
PRESSURE		16K				20K				Class 150				10K				10K			
END CONNECTION		BS21 (JIS B0203)				BS21 (JIS B0203)				ASME B16.5				BS21 (JIS B0203)				JIS B2239			
DIMENSIONS	inch	mm	L	H	D	L	H	D	L	H	D	L	H	D	L	H	D				
	1/4	8	-	-	-	-	-	-	-	-	-	50	108	60	-	-	-				
	3/8	10	-	-	-	-	-	-	-	-	-	55	108	60	85	108	60				
	1/2	15	65	163	70	70	175	90	-	-	-	65	122	70	85	122	70				
	3/4	20	75	182	80	75	177	90	-	-	-	80	125	80	95	125	80				
	1	25	80	212	90	85	214	100	-	-	-	90	146	90	110	146	90				
	1 1/4	32	90	245	100	95	241	115	-	-	-	105	160	100	130	160	100				
	1 1/2	40	100	285	115	105	277	135	165	300	160	120	180	115	150	180	115				
	2	50	110	330	135	115	301	135	178	352	200	140	198	135	180	198	135				
	2 1/2	65	-	-	-	-	-	-	190	408	200	180	250	180	210	250	180				
	3	80	-	-	-	-	-	-	203	473	250	200	280	225	240	280	225				
	4	100	-	-	-	-	-	-	229	566	250	-	-	-	-	-	-				
	5	125	-	-	-	-	-	-	254	667	300	-	-	-	-	-	-				
	6	150	-	-	-	-	-	-	267	779	300	-	-	-	-	-	-				
	8	200	-	-	-	-	-	-	292	969	350	-	-	-	-	-	-				
	10	250	-	-	-	-	-	-	330	1181	400	-	-	-	-	-	-				
	12	300	-	-	-	-	-	-	356	1404	450	-	-	-	-	-	-				
BODY		Ductile Iron				Ductile Iron				Ductile Iron				Ductile Iron				Ductile Iron			
BONNET		Ductile Iron				Ductile Iron				Ductile Iron				Ductile Iron				Ductile Iron			
STEM		Stainless Steel				Stainless Steel				Stainless Steel				Stainless Steel				Stainless Steel			
DISC		Stainless Steel				Stainless Steel				Stainless Steel / Carbon Steel / Cast Steel				Stainless Steel				Stainless Steel			



TYPE		GLOBE			GLOBE			GLOBE			GLOBE			GLOBE			
Ductile Iron																	
FIG		10SP			10SPBF			10SPBOF			10SPD			10SPDBF			
PRESSURE		10K			10K			10K			10K			10K			
END CONNECTION		BS21 (JIS B0203)			JIS B2239			JIS B2239			BS21 (JIS B0203)			JIS B2239			
DIMENSIONS	inch	mm	L	H	D	L	H	D	L	H	D	L	H	D	L	H	D
	3/8	10	64	107	60	108	107	60	-	-	-	-	-	-	-	-	-
	1/2	15	70	125	80	108	125	80	-	-	-	70	125	80	108	125	80
	3/4	20	80	125	80	117	125	80	-	-	-	80	125	80	117	125	80
	1	25	90	145	100	127	145	100	-	-	-	90	146	100	127	145	100
	1 1/4	32	110	162	115	140	162	115	-	-	-	110	162	115	140	162	115
	1 1/2	40	120	180	115	165	180	115	-	-	-	120	180	115	165	180	115
	2	50	140	198	135	203	198	135	203	302	200	140	198	135	203	198	135
	2 1/2	65	-	-	-	-	-	-	216	317	225	-	-	-	-	-	-
	3	80	-	-	-	-	-	-	241	356	250	-	-	-	-	-	-
	4	100	-	-	-	-	-	-	292	377	250	-	-	-	-	-	-
	5	125	-	-	-	-	-	-	356	460	300	-	-	-	-	-	-
	6	150	-	-	-	-	-	-	406	524	350	-	-	-	-	-	-
	8	200	-	-	-	-	-	-	495	585	400	-	-	-	-	-	-
BODY		Ductile Iron			Ductile Iron			Ductile Iron			Ductile Iron			Ductile Iron			
#ONNET		Ductile Iron			Ductile Iron			Ductile Iron			Ductile Iron			Ductile Iron			
STEM		Stainless Steel			Stainless Steel			Stainless Steel			Stainless Steel			Stainless Steel			
DISC		Stainless Steel			Stainless Steel			Stainless Steel / Ductile Iron			G/F PTFE			G/F PTFE			
											Soft Seated disc			Soft Seated disc			

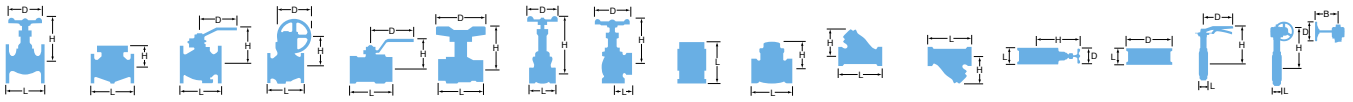
TYPE		GLOBE			GLOBE			GLOBE			GLOBE			GLOBE			
Ductile Iron																	
FIG		10SPDDBF			10SD			10SDDBF			10SDL			10SDLBF			
PRESSURE		10K			10K			10K			10K			10K			
END CONNECTION		JIS B2239			BS21 (JIS B0203)			JIS B2239			BS21 (JIS B0203)			JIS B2239			
DIMENSIONS	inch	mm	L	H	D	L	H	D	L	H	D	L	H	D	L	H	D
	1/4	8	-	-	-	50	108	60	-	-	-	-	-	-	-	-	-
	3/8	10	-	-	-	55	108	60	85	108	60	55	112	55	85	112	55
	1/2	15	-	-	-	65	123	70	85	123	70	65	122	60	85	122	60
	3/4	20	-	-	-	80	123	80	95	123	80	80	130	70	95	130	70
	1	25	-	-	-	90	144	90	110	144	90	90	149	80	110	149	80
	1 1/4	32	-	-	-	105	159	100	130	159	100	105	169	90	130	169	90
	1 1/2	40	-	-	-	120	178	115	150	178	115	120	187	100	150	187	100
	2	50	203	302	200	140	197	135	180	197	135	140	205	115	180	205	115
	2 1/2	65	216	317	225	180	262	180	210	262	180	-	-	-	-	-	-
	3	80	241	356	250	200	295	225	240	295	225	-	-	-	-	-	-
	4	100	292	377	250	-	-	-	-	-	-	-	-	-	-	-	-
	5	125	356	460	300	-	-	-	-	-	-	-	-	-	-	-	-
	6	150	406	527	350	-	-	-	-	-	-	-	-	-	-	-	-
	8	200	495	600	400	-	-	-	-	-	-	-	-	-	-	-	-
BODY		Ductile Iron			Ductile Iron			Ductile Iron			Ductile Iron			Ductile Iron			
#ONNET		Ductile Iron			Ductile Iron			Ductile Iron			Ductile Iron			Ductile Iron			
STEM		Stainless Steel			Stainless Steel			Stainless Steel			Stainless Steel			Stainless Steel			
DISC		G/F PTFE			G/F PTFE			G/F PTFE			G/F PTFE			G/F PTFE			
		Soft Seated disc			Soft Seated disc			Soft Seated disc			Soft Seated disc			Soft Seated disc			

Bronze & Brass
 Cast Iron
 Ductile Iron
 Stainless Steel
 Carbon Steel
 Butterfly Valve
 Ball Valve
 Ball Valve Seal
 Actuated Valve



TYPE		GLOBE					GLOBE			GLOBE			GLOBE			GLOBE		
Ductile Iron																		
FIG		16SP					16SPB			16SPBO			20SY			20SYB		
PRESSURE		16K					16K			16K			20K			20K		
END CONNECTION		BS21 (JIS B0203)					JIS B2239			JIS B2239			BS21 (JIS B0203)			JIS B2239		
DIMENSIONS	inch	mm	L	H	D	L	H	D	L	H	D	L	H	D	L	H	D	
	3/8	10	64	110	60	108	111	60	—	—	—	75	136	70	110	136	70	
	1/2	15	70	122	80	108	122	80	—	—	—	78	138	80	110	138	80	
	3/4	20	85	128	80	117	128	80	—	—	—	91	157	100	120	157	100	
	1	25	95	147	100	127	146	100	—	—	—	105	178	115	130	178	115	
	1 1/4	32	110	165	115	140	165	115	—	—	—	122	202	135	160	202	135	
	1 1/2	40	125	182	115	165	182	115	—	—	—	135	210	135	180	210	135	
	2	50	145	196	135	203	198	135	203	302	200	160	239	180	230	239	180	
	2 1/2	65	—	—	—	—	—	—	216	313	225	—	—	—	—	—	—	
	3	80	—	—	—	—	—	—	241	356	250	—	—	—	—	—	—	
	4	100	—	—	—	—	—	—	292	377	250	—	—	—	—	—	—	
	5	125	—	—	—	—	—	—	356	460	300	—	—	—	—	—	—	
	6	150	—	—	—	—	—	—	406	524	350	—	—	—	—	—	—	
	8	200	—	—	—	—	—	—	495	585	400	—	—	—	—	—	—	
BODY		Ductile Iron					Ductile Iron			Ductile Iron			Ductile Iron			Ductile Iron		
BONNET		Ductile Iron					Ductile Iron			Ductile Iron			Ductile Iron			Ductile Iron		
STEM		Stainless Steel					Stainless Steel			Stainless Steel			Stainless Steel			Stainless Steel		
DISC		Stainless Steel					Stainless Steel			Stainless Steel / Ductile Iron			Stainless Steel+HF			Stainless Steel+HF		

TYPE		GLOBE					GLOBE			LIFT CHECK			LIFT CHECK			LIFT CHECK		
Ductile Iron																		
FIG		150SPB					150SPDB			10SF			10SFBF			10SN		
PRESSURE		Class 150					Class 150			10K			10K			10K		
END CONNECTION		ASME B16.5					ASME B16.5			BS21 (JIS B0203)			JIS B2239			BS21 (JIS B0203)		
DIMENSIONS	inch	mm	L	H	D	L	H	D	L	H	D	L	H	D	L	H	D	
	1/2	15	108	122	80	108	127	70	65	39	—	85	39	—	70	50	—	
	3/4	20	117	128	80	117	135	70	80	42	—	95	42	—	80	53	—	
	1	25	127	146	100	127	155	90	90	48	—	110	48	—	90	61	—	
	1 1/4	32	140	165	115	140	172	100	105	56	—	130	56	—	110	69	—	
	1 1/2	40	165	179	115	165	193	115	120	65	—	150	65	—	120	75	—	
	2	50	203	198	135	203	208	135	140	73	—	180	73	—	140	87	—	
BODY		Ductile Iron					Ductile Iron			Ductile Iron			Ductile Iron			Ductile Iron		
BONNET		Ductile Iron					Ductile Iron			—			—			—		
CAP		—					—			Stainless Steel			Stainless Steel			Stainless Steel		
STEM		Stainless Steel					Stainless Steel			—			—			—		
DISC		Stainless Steel					G/F PTFE			Stainless Steel			Stainless Steel			Stainless Steel		
							Soft Seated disc											



TYPE	LIFT CHECK					LIFT CHECK			LIFT CHECK			LIFT CHECK			SWING CHECK		
Ductile Iron																	
FIG	10SNBF					16SF			16SFB			20SN			10SRBF		
PRESSURE	10K					16K			16K			20K			10K		
END CONNECTION	JIS B2239					BS21 (JIS B0203)			JIS B2239			BS21 (JIS B0203)			JIS B2239		
DIMENSIONS	inch	mm	L	H	D	L	H	D	L	H	D	L	H	D	L	H	D
	1/2	15	108	50	—	70	50	—	108	50	—	78	56	—	—	—	—
	3/4	20	117	53	—	85	53	—	117	53	—	91	60	—	—	—	—
	1	25	127	61	—	95	61	—	127	61	—	105	68	—	—	—	—
	1 1/4	32	140	69	—	110	69	—	140	69	—	122	80	—	—	—	—
	1 1/2	40	165	75	—	125	75	—	165	75	—	135	85	—	165	115	—
	2	50	203	87	—	145	87	—	203	87	—	160	99	—	203	120	—
	2 1/2	65	—	—	—	—	—	—	—	—	—	—	—	—	216	130	—
	3	80	—	—	—	—	—	—	—	—	—	—	—	—	241	145	—
	4	100	—	—	—	—	—	—	—	—	—	—	—	—	292	160	—
	5	125	—	—	—	—	—	—	—	—	—	—	—	—	330	195	—
	6	150	—	—	—	—	—	—	—	—	—	—	—	—	356	215	—
8	200	—	—	—	—	—	—	—	—	—	—	—	—	495	255	—	
10	250	—	—	—	—	—	—	—	—	—	—	—	—	622	310	—	
12	300	—	—	—	—	—	—	—	—	—	—	—	—	698	350	—	
BODY	Ductile Iron					Ductile Iron			Ductile Iron			Ductile Iron			Ductile Iron		
CAP	Stainless Steel					Stainless Steel			Stainless Steel			Stainless Steel			—		
COVER	—					—			—			—			Ductile Iron		
HINGE PIN	—					—			—			—			Stainless Steel		
DISC	Stainless Steel					Stainless Steel			Stainless Steel			Stainless Steel+HF			Stainless Steel / Cast Steel		
SEAT	—					—			—			—			—		

TYPE	SWING CHECK			SWING CHECK			SWING CHECK				
Ductile Iron											
FIG	16SRB			20SOB			150SRB				
PRESSURE	16K			20K			Class 150				
END CONNECTION	JIS B2239			JIS B2239			ASME B16.5				
DIMENSIONS	inch	mm	L	H	D	L	H	D	L	H	D
	1 1/2	40	—	—	—	—	—	—	165	115	—
	2	50	203	120	—	267	135	—	203	120	—
	2 1/2	65	216	135	—	292	145	—	216	130	—
	3	80	241	145	—	318	160	—	241	145	—
	4	100	292	165	—	356	185	—	292	165	—
	5	125	330	200	—	400	220	—	330	200	—
	6	150	356	220	—	444	240	—	356	220	—
	8	200	495	265	—	533	275	—	495	260	—
	10	250	622	320	—	622	335	—	622	320	—
	12	300	698	360	—	711	370	—	698	360	—
	BODY	Ductile Iron			Ductile Iron			Ductile Iron			
COVER	Ductile Iron			Ductile Iron			Ductile Iron				
HINGE PIN	Stainless Steel			Stainless Steel			Stainless Steel				
DISC	Stainless Steel / Cast Steel			Stainless Steel / Cast Steel			Stainless Steel / Cast Steel				

Bronze & Brass

Cast Iron

Ductile Iron

Stainless Steel

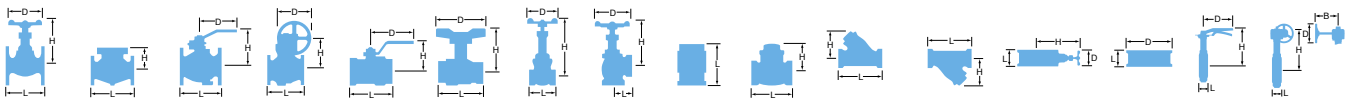
Carbon Steel

Butterfly Valve

Ball Valve

Ball Valve Seal

Actuated Valve



TYPE	WAFER CHECK					WAFER CHECK			WAFER CHECK		
Ductile Iron											
FIG	10SWZU					20SWZ			20SWZU		
PRESSURE	10K					20K			20K		
END CONNECTION	Wafer Type					Wafer Type			Wafer Type		
DIMENSIONS	inch	mm	L	H	D	L	H	D	L	H	D
	1 1/2	40	—	—	—	54	128	55	—	—	—
	2	50	56	161	70	56	133	60	56	146	60
	2 1/2	65	56	168	70	60	150	70	60	168	70
	3	80	59	174	70	67	156	70	67	174	70
	4	100	66	187	70	68	169	70	68	187	70
	5	125	72	201	70	83	183	70	83	201	70
	6	150	78	220	80	95	216	80	95	219	80
	8	200	96	247	80	127	243	80	127	247	80
	10	250	109	298	90	140	290	90	140	297	90
	12	300	145	324	90	181	315	90	181	324	90
	14	350	184	337	90	184	330	90	184	337	90
	16	400	191	365	90	191	355	90	191	365	90
	18	450	204	394	90	204	388	90	204	394	90
BODY	Ductile Iron+NBR					Ductile Iron+NBR			Ductile Iron+NBR		
BOHNET	Ductile Iron					Forged Brass / Cast Bronze			Ductile Iron		
HINGE PIN	Stainless Steel					Stainless Steel			Stainless Steel		
DISC	Stainless Steel					Cast Bronze / Brass			Stainless Steel		

TYPE	Y TYPE STRAINER					Y TYPE STRAINER			Y TYPE STRAINER			Y TYPE STRAINER			Y TYPE STRAINER		
Ductile Iron																	
FIG	10FDY					10FDYBF			16FDY			16FDYB			20FDY		
PRESSURE	10K					10K			16K			16K			20K		
END CONNECTION	BS21 (JIS B0203)					JIS B2239			BS21 (JIS B0203)			JIS 2239			BS21 (JIS B0203)		
DIMENSIONS	inch	mm	L	H	D	L	H	D	L	H	D	L	H	D	L	H	D
	1/4	8	65	46	—	—	—	—	—	—	—	—	—	—	—	—	—
	3/8	10	70	46	—	—	—	—	—	—	—	—	—	—	80	65	—
	1/2	15	85	60	—	125	57	—	85	60	—	125	57	—	85	65	—
	3/4	20	100	65	—	140	63	—	100	65	—	140	63	—	100	70	—
	1	25	115	75	—	150	77	—	115	75	—	150	77	—	115	83	—
	1 1/4	32	135	90	—	170	90	—	135	90	—	170	90	—	135	120	—
	1 1/2	40	150	100	—	190	100	—	150	100	—	190	100	—	150	130	—
	2	50	180	115	—	230	138	—	180	115	—	250	158	—	180	152	—
	2 1/2	65	220	191	—	305	212	—	—	—	—	305	212	—	—	—	—
	3	80	250	215	—	360	242	—	—	—	—	360	242	—	—	—	—
	4	100	—	—	—	415	284	—	—	—	—	415	284	—	—	—	—
	5	125	—	—	—	465	325	—	—	—	—	465	325	—	—	—	—
	6	150	—	—	—	515	370	—	—	—	—	515	370	—	—	—	—
	8	200	—	—	—	580	462	—	—	—	—	580	462	—	—	—	—
	10	250	—	—	—	680	536	—	—	—	—	680	536	—	—	—	—
	12	300	—	—	—	800	625	—	—	—	—	800	625	—	—	—	—
BODY	Ductile Iron					Ductile Iron			Ductile Iron			Ductile Iron			Ductile Iron		
CAP	Forged Brass					Forged Brass			Forged Brass			Forged Brass			—		
COVER	Ductile Iron					Ductile Iron			—			Ductile Iron			Ductile Iron		
SCREEN	Stainless Steel					Stainless Steel			Stainless Steel			Stainless Steel			Stainless Steel		

STAINLESS STEEL

Stainless Steel

General Design Specifications

Series	Normal pressure	Pressure - temperature ratings*	Face to face dimensions	End connection dimensions	Wall Thickness
A	10K	JIS B2220	JIS B2002	JIS B2220 10K flanged	ASME B16.34
	20K			JIS B2220 20K flanged	
	Class 150/300/600	ASME B16.34	ASME B16.10	ASME B16.5 flanged	
HA	10K	JIS B2220	JIS B2002	JIS B2220 10K flanged	API 603
	20K			JIS B2220 20K flanged	
	Class 150/300	ASME B16.34	ASME B16.10	ASME B16.5 flanged	
C	Class 150/300/600/900/1500	ASME B16.34	ASME B16.10	ASME B16.5 flanged	API 600
B	5K	0.5MPa 150°C	JIS B 2011 KITZ Std.	JIS B0203 threaded JIS B2220 5K 10K flanged	JIS B 2011 KITZ Std.
	10K	1.0MPa 180°C			
	20K	2.0MPa 180°C			
	Type 200	KITZ Std.		ASME B1.20.1 threaded	
D	Class 150/300/600	ASME B16.34	KITZ Std.	ASME B1.20.1 threaded ASME B16.11 socket welded	ASME B16.34
AJ	10K	JIS B2220	KITZ Std.	JIS B2220 10K flanged	ASME B16.34
	20K			JIS B2220 20K flanged	
	Class 150/300	ASME B16.34		ASME B16.5 flanged	

*Actual pressure-temperature rating in service depends on the materials of gland packing and gasket chosen for valves.

Bonnet Gasket Materials

Depending on the class ratings and servicing conditions, the following gasket materials are available* for the body/bonnet flange gaskets of KITZ stainless and high alloy steel valves. Specify your gasket material in your purchase order.

Series	Series C			Series A·HA·D·AJ		
	Class 150	Class 300	Class 600/900/1500	10K, Class 150	20k, Class 300	Class 600
Corrugated metal	●					
Ring joint metal			●			
Spiral wound metal, PTFE filled		●			●	●
Flexible graphite	●			●	●	
Spiral wound metal, flexible graphite filled		●			●	●
Stainless steel inserted flexible graphite	●			●	●	
Ceramic filled PTFE	●			●	●	

Please refer to our website (www.kitz.co.jp) or contact KITZ for details. *Except Series B valves, which employ only KITZ standard materials.

Gland Packing Materials



The following packing materials can be chosen for KITZ stainless and high alloy steel valves, depending on the service conditions or market requirements. Specify your packing material in your purchase order.

Asbestos-free	Packing material	Service conditions
		Braided PTFE fiber
	PTFE cup & cone / PTFE V-ring	150°C (300°F) corrosion resistant
	Carbon fiber	500°C (930°F) high pressure
	Flexible graphite	600°C (1110°F)* corrosion resistant
	Inconel wired flexible graphite	600°C (1110°F)* corrosion resistant

Please refer to our website (www.kitz.co.jp) or contact KITZ for details. *Except Series B valves, which employ only KITZ standard materials. *455°C (850°F) for oxidizing atmosphere.

Contact KITZ Corporation or your KITZ distributors for an optional requirement for gasket or gland packing materials other than those listed above.

Disc Construction

Series	Nominal pressure	Solid wedge 	Flexible wedge 
A	10K, 20K, Class 150, 300, 600	—	All sizes
HA	10K, 20K, Class 150, 300	—	All sizes
C	Class 150, 300, 600, 900, 1500	1 1/2 and smaller	2 and larger
B	5K, 10K, 20K, 200	All sizes	—
D	Class 150, 300, 600	—	All sizes
AJ	10K, 20K, Class 150, 300	—	All sizes

Pressure-Temperature Ratings for Series B (KITZ Standard)

Temperature	W	G1	G2
	120°C below	150°C below	180°C below
5K	0.7	0.5	—
10K	1.4	1.1	1.0
20K	2.0	1.2	1.0

MPa

W: Static water without pressure variation

G1,G2: Steam, air, non-inflammable gas and oil (lubricant and machining oil)

Note: Actual pressure-temperature rating in service depends on the materials of gland packing and gasket chosen for valves.

Product Coding (Except for Series B)

AK-150 U M A M 4

1 2 3 4 5 6 7

1 End connection

None.. RF-Flanged with smooth finished gasket face

AK..... Threaded Ends to ASME B1.20.1 NPT

AW..... Socket Welding Ends to ASME B16.11

2 Nominal pressure

Code	Nominal pressure	Code	Nominal pressure
5	JIS 5K	300	ASME 300
10	JIS 10K	600	ASME 600
20	JIS 20K	900	ASME 900
150	ASME Class150	1500	ASME Class1500

3 Product identification

U.. Identification code for stainless and high alloy steel valves in general.

4 Valve type

M... Gate valves
P... Globe valves
PD..Soft Seated Globe valves
O... Swing Check valves
N... Lift Check valves
Y... Y-pattern Strainers

5 Valve design

Code Series
A..... Series A
HA..... Series HA
C..... Series C
None.. Series D
AJ..... Series A, Jacketed
AW..... Series A, Bellows Seal

6 Shell material

None..CF8 (304)
M.....CF8M (316)
O.....CF3M (316L)
V..... CF3 (304L)
CB..... CF8C (321)
CG..... CG8M (317)
CK..... CK20 (310)
SD..... Super Duplex Stainless Steel (SDPV-K1)
CN..... CN7M (Alloy 20)
HB..... N-12MV (Hastelloy B)
HC..... CW-12MW (Hastelloy C)

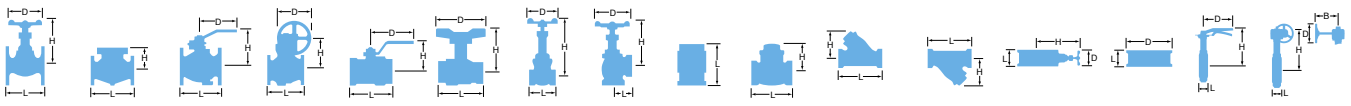
7 Nominal valve size

JIS flanged.. in mm base
Others..... in inches base

KITZ Low Emission Valves

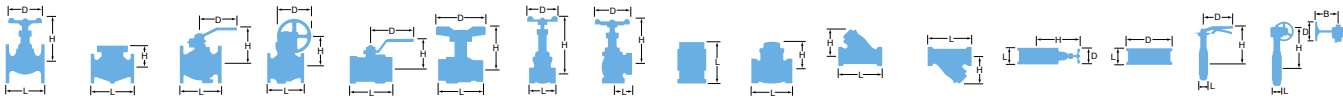
In the United States, the Federal Clean Air Act was amended drastically in 1990 in order to realize the new environmental protection policy of a 95% reduction in fugitive emission or leak levels of toxic gases and chemicals from plant equipment. Promulgated in April 1994, the new law requires all plants handling a toxic gas specified by the Environmental Protection Agency to periodically monitor their plant equipment for the detection of leaks exceeding 500 ppm, and to repair or replace all defective parts immediately. California has exceeded the Federal Law with a state regulation requiring a maximum leak level of 100 ppm for an astonishing 99% reduction in such environmental pollution for the Northern California Region after 1997.

Our low emission valves—the proud fruits of several years of trial and error at our laboratory—are designed, engineered, manufactured, and tested to now meet the 100-ppm maximum emission level. This is the standard specification in North America for KITZ Class 150, 300, and 600 Series A and C stainless and high alloy steel valves. In other markets, all these low emission valves are optionally available. Major design considerations for having upgraded our standard valves to low emission performance are introduced below.



TYPE		B-SERIES GATE			B-SERIES GATE			B-SERIES GATE			B-SERIES GATE			B-SERIES GATE			
Stainless Steel																	
FIG		UE			UEM			UEB			UEBM			UEL			
PRESSURE		10K			10K			10K			10K			10K			
END CONNECTION		BS21 (JIS B0203)			BS21 (JIS B0203)			JIS B2220			JIS B2220			BS21 (JIS B0203)			
DIMENSIONS	inch	mm	L	H	D	L	H	D	L	H	D	L	H	D	L	H	D
	1/2	15	-	-	-	-	-	-	85	99	70	-	-	-	54	96	70
	3/4	20	-	-	-	-	-	-	95	105	70	-	-	-	58	101	70
	1	25	-	-	-	-	-	-	100	116	80	100	116	80	65	112	80
	1 1/4	32	-	-	-	-	-	-	110	128	80	110	128	80	74	123	80
	1 1/2	40	-	-	-	-	-	-	125	170	100	125	170	100	78	150	100
	2	50	-	-	-	-	-	-	140	188	100	140	188	100	87	167	100
	2 1/2	65	115	248	135	115	248	135	170	248	135	170	248	135	-	-	-
	3	80	130	275	155	130	275	155	190	275	155	190	275	155	-	-	-
	4	100	155	315	200	155	315	200	-	-	-	-	-	-	-	-	-
BODY		Stainless Steel			Stainless Steel			Stainless Steel			Stainless Steel			Stainless Steel			
BONNET		Stainless Steel			Stainless Steel			Stainless Steel			Stainless Steel			Stainless Steel			
STEM		Stainless Steel			Stainless Steel			Stainless Steel			Stainless Steel			Stainless Steel			
DISC		Stainless Steel			Stainless Steel			Stainless Steel			Stainless Steel			Stainless Steel			

TYPE		B-SERIES GATE			B-SERIES GATE			A-SERIES GATE			A-SERIES GATE			A-SERIES GATE			
Stainless Steel																	
FIG		UELM			DKUELM			10UMA / 10UMAT			10UMAM / 10UMAMT			20UMA / 20UMAT			
PRESSURE		10K			PN16			10K			10K			20K			
END CONNECTION		BS21 (JIS B0203)			DIN 259			JIS B2220			JIS B2220			JIS B2220			
DIMENSIONS	inch	mm	L	H	D	L	H	D	L	H	D	L	H	D	L	H	D
	1/2	15	54	96	70	54	96	70	108	201	90	108	201	90	140	209	100
	3/4	20	58	101	70	58	101	70	117	211	90	117	211	90	152	220	100
	1	25	65	112	80	65	112	80	127	224	100	127	224	100	165	239	100
	1 1/4	32	74	123	80	74	123	80	140	240	100	140	240	100	-	-	-
	1 1/2	40	78	150	100	78	150	100	165	284	140	165	284	140	190	294	140
	2	50	87	167	100	87	167	100	178	336	160	178	336	160	216	355	180
	2 1/2	65	-	-	-	-	-	-	190	374	180	190	374	180	241	404	180
	3	80	-	-	-	-	-	-	203	444	200	203	444	200	283	472	225
	4	100	-	-	-	-	-	-	229	523	225	229	523	225	305	560	250
	5	125	-	-	-	-	-	-	254	606	250	254	606	250	381	626	300
	6	150	-	-	-	-	-	-	267	711	250	267	711	250	403	753	350
	8	200	-	-	-	-	-	-	292	924	300	292	924	300	419	968	400
	10	250	-	-	-	-	-	-	330	1126	350	330	1126	350	457	1177	450
	12	300	-	-	-	-	-	-	356	1336	400	356	1336	400	502	1378	500
	14	350	-	-	-	-	-	-	381	1491	450	381	1491	450	562	1590	600
	16	400	-	-	-	-	-	-	406	1692	600	406	1692	600	638	1810	600
	18	450	-	-	-	-	-	-	432	1891	600	432	1891	600	714	1980	680
	20	500	-	-	-	-	-	-	457	2102	680	457	2102	680	791	2190	760
	24	600	-	-	-	-	-	-	508	2463	760	508	2463	760	1143	2580	910
BODY		Stainless Steel			Stainless Steel			Stainless Steel			Stainless Steel			Stainless Steel			
BONNET		Stainless Steel			Stainless Steel			Stainless Steel			Stainless Steel			Stainless Steel			
STEM		Stainless Steel			Stainless Steel			Stainless Steel			Stainless Steel			Stainless Steel			
DISC		Stainless Steel			Stainless Steel			Stainless Steel			Stainless Steel			Stainless Steel			
								Fig. 10UMAT : Gland Packing / PTFE			Fig. 10UMAMT : Gland Packing / PTFE			Fig. 20UMAT : Gland Packing / PTFE			



TYPE		A-SERIES GATE					A-SERIES GATE			A-SERIES GATE			A-SERIES GATE			A-SERIES GATE		
Stainless Steel																		
FIG		20UMAM / 20UMAMT					150UMA / 150UMAT			150UMAM / 150UMAMT			300UMA			300UMAM		
PRESSURE		20K					Class 150			Class 150			Class 300			Class 300		
END CONNECTION		JIS B2220					ASME B16.5			ASME B16.5			ASME B16.5			ASME B16.5		
DIMENSIONS		inch	mm	L	H	D	L	H	D	L	H	D	L	H	D	L	H	D
		1/2	15	140	209	100	108	201	90	108	201	90	140	209	100	140	209	100
		3/4	20	152	220	100	117	211	90	117	211	90	152	220	100	152	220	100
		1	25	165	239	100	127	224	100	127	224	100	165	239	100	165	239	100
		1 1/2	40	190	294	140	165	284	140	165	284	140	190	294	140	190	294	140
		2	50	216	355	180	178	336	160	178	336	160	216	355	180	216	355	180
		2 1/2	65	241	404	180	190	374	180	190	374	180	241	404	180	241	404	180
		3	80	283	472	225	203	444	200	203	444	200	283	472	225	283	472	225
		4	100	305	560	250	229	523	225	229	523	225	305	560	250	305	560	250
		5	125	381	626	300	254	606	250	254	606	250	381	626	300	381	626	300
		6	150	403	753	350	267	711	250	267	711	250	403	753	350	403	753	350
		8	200	419	968	400	292	924	300	292	924	300	419	968	400	419	968	400
		10	250	457	1177	450	330	1126	350	330	1126	350	457	1177	450	457	1177	450
		12	300	502	1378	500	356	1336	400	356	1336	400	502	1378	500	502	1378	500
		14	350	762	1590	600	381	1491	450	381	1486	450	762	1590	600	762	1590	600
		16	400	838	1810	600	406	1690	600	406	1690	600	838	1810	600	838	1810	600
		18	450	914	1980	680	432	1890	600	432	1890	600	914	1980	680	914	1980	680
		20	500	991	2190	760	457	2100	680	457	2100	680	991	2190	760	991	2190	760
		24	600	1143	2580	910	508	2460	760	508	2460	760	1143	2580	910	1143	2580	910
BODY		Stainless Steel					Stainless Steel			Stainless Steel			Stainless Steel			Stainless Steel		
BONNET		Stainless Steel					Stainless Steel			Stainless Steel			Stainless Steel			Stainless Steel		
STEM		Stainless Steel					Stainless Steel			Stainless Steel			Stainless Steel			Stainless Steel		
DISC		Stainless Steel					Stainless Steel			Stainless Steel			Stainless Steel			Stainless Steel		
		Fig. 20UMAMT : Gland Packing / PTFE					Fig. 150UMAT : Gland Packing / PTFE			Fig. 150UMAMT : Gland Packing / PTFE								

TYPE		A-SERIES GATE				A-SERIES GATE			
Stainless Steel									
FIG		600UMA				600UMAM			
PRESSURE		Class 600				Class 600			
END CONNECTION		ASME B16.5				ASME B16.5			
DIMENSIONS		inch	mm	L	H	D	L	H	D
		1/2	15	165	210	100	165	210	100
		3/4	20	190	224	100	190	224	100
		1	25	216	251	140	216	251	140
		1 1/2	40	241	333	180	241	333	180
		2	50	292	451	200	292	451	200
		2 1/2	65	330	482	225	330	482	225
		3	80	356	545	250	356	545	250
		4	100	432	676	350	432	676	350
		6	150	559	904	450	559	904	450
		8	200	660	1128	500	660	1128	500
		10	250	787	1329	600	787	1329	600
		12	300	838	1521	680	838	1521	680
BODY		Stainless Steel				Stainless Steel			
BONNET		Stainless Steel				Stainless Steel			
STEM		Stainless Steel				Stainless Steel			
DISC		Stainless Steel				Stainless Steel			

Bronze & Brass

Cast Iron

Ductile Iron

Stainless Steel

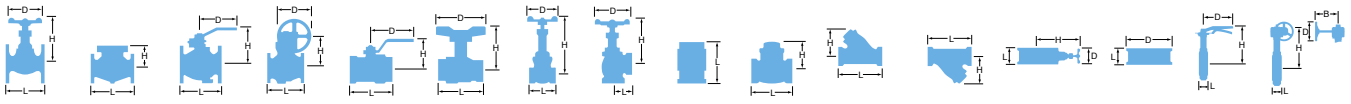
Carbon Steel






Butterfly Valve

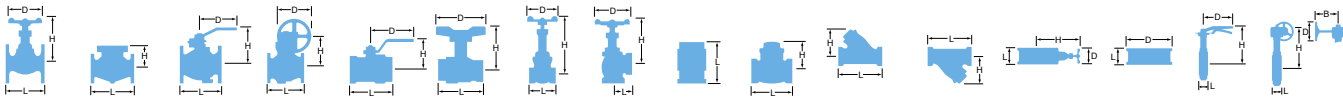
Ball Valve

Ball Valve Seal

Actuated Valve



TYPE		AJ-SERIES GATE			AJ-SERIES GATE			AJ-SERIES GATE			AJ-SERIES GATE			B-SERIES GLOBE			
Stainless Steel																	
FIG		100MAJ			200MAJ			150MAJ			300MAJ			UAB			
PRESSURE		10K			20K			Class 150			Class 300			5K			
END CONNECTION		JIS B2220			JIS B2220			ASME B16.5			ASME B16.5			JIS B2220			
DIMENSIONS	inch	mm	L	H	D	L	H	D	L	H	D	L	H	D	L	H	D
	3/8	10	—	—	—	—	—	—	—	—	—	—	—	—	73	106	70
	1/2	15	169	204	100	173	199	100	165	204	100	178	199	100	85	106	70
	3/4	20	169	214	100	173	213	100	165	214	100	178	213	100	95	108	70
	1	25	177	233	100	181	232	100	177	233	100	190	232	100	108	119	80
	1 1/4	32	—	—	—	—	—	—	—	—	—	—	—	—	120	142	90
	1 1/2	40	188	286	140	192	283	140	187	286	140	203	283	140	135	155	90
	2	50	201	336	160	270	353	180	203	336	160	283	353	180	155	186	115
	3	80	217	444	200	289	470	225	229	444	200	305	470	225	—	—	—
	4	100	260	523	225	386	560	250	267	523	225	403	560	250	—	—	—
	6	150	279	710	250	434	753	350	292	710	250	457	753	350	—	—	—
BODY		Stainless Steel			Stainless Steel			Stainless Steel			Stainless Steel			Stainless Steel			
BONNET		Stainless Steel			Stainless Steel			Stainless Steel			Stainless Steel			Stainless Steel			
STEM		Stainless Steel			Stainless Steel			Stainless Steel			Stainless Steel			Stainless Steel			
DISC		Stainless Steel			Stainless Steel			Stainless Steel			Stainless Steel			Stainless Steel			
		Full Jacketed			Full Jacketed			Full Jacketed			Full Jacketed						



TYPE		B-SERIES GLOBE					B-SERIES GLOBE			B-SERIES GLOBE			B-SERIES GLOBE			B-SERIES GLOBE		
Stainless Steel																		
FIG		UCL					UCB			UD			UDM			UDB		
PRESSURE		10K					10K			10K			10K			10K		
END CONNECTION		BS21 (JIS B0203)					JIS B2220			BS21 (JIS B0203)			BS21 (JIS B0203)			JIS B2220		
DIMENSIONS		inch	mm	L	H	D	L	H	D	L	H	D	L	H	D	L	H	D
		1/4	8	44	68	55	—	—	—	—	—	—	—	—	—	—	—	—
		3/8	10	48	68	55	73	106	70	55	109	60	55	109	60	—	—	—
		1/2	15	52	68	55	85	106	70	65	112	60	65	112	60	85	112	60
		3/4	20	60	93	60	95	108	70	80	113	70	80	113	70	95	113	70
		1	25	72	100	70	108	119	80	90	143	90	90	143	90	110	143	90
		1 1/4	32	80	122	80	120	142	90	105	150	90	105	150	90	130	150	90
		1 1/2	40	90	138	90	135	155	90	120	171	100	120	171	100	150	171	100
		2	50	100	153	100	155	186	115	140	189	115	140	189	115	180	189	115
		2 1/2	65	—	—	—	—	—	—	—	—	—	—	—	—	210	252	180
		3	80	—	—	—	—	—	—	—	—	—	—	—	—	240	277	225
BODY		Stainless Steel					Stainless Steel			Stainless Steel			Stainless Steel			Stainless Steel		
BONNET		Stainless Steel					Stainless Steel			Stainless Steel			Stainless Steel			Stainless Steel		
STEM		Stainless Steel					Stainless Steel			Stainless Steel			Stainless Steel			Stainless Steel		
DISC		Stainless Steel					Stainless Steel			PTFE			PTFE			PTFE		
										Soft-Seated disc			Soft-Seated disc			Soft-Seated disc		

TYPE		B-SERIES GLOBE					B-SERIES GLOBE			B-SERIES GLOBE			B-SERIES GLOBE			B-SERIES GLOBE		
Stainless Steel																		
FIG		UDBM					UJ			UJM			UJB			UJBM		
PRESSURE		10K					10K			10K			10K			10K		
END CONNECTION		JIS B2220					BS21 (JIS B0203)			BS21 (JIS B0203)			JIS B2220			JIS B2220		
DIMENSIONS		inch	mm	L	H	D	L	H	D	L	H	D	L	H	D	L	H	D
		3/8	10	—	—	—	55	109	60	55	109	60	85	109	60	85	109	60
		1/2	15	85	112	60	65	111	60	65	111	60	85	111	60	85	111	60
		3/4	20	95	113	70	80	112	70	80	112	70	95	112	70	95	112	70
		1	25	110	143	90	90	142	90	90	142	90	110	142	90	110	142	90
		1 1/4	32	130	150	90	105	150	90	105	150	90	130	150	90	130	150	90
		1 1/2	40	150	171	100	120	171	100	120	171	100	150	171	100	150	171	100
		2	50	180	189	115	140	189	115	140	189	115	180	189	115	180	189	115
		2 1/2	65	210	252	180	180	253	180	180	253	180	210	253	180	210	253	180
		3	80	240	277	225	200	280	225	200	280	225	240	280	225	240	280	225
BODY		Stainless Steel					Stainless Steel			Stainless Steel			Stainless Steel			Stainless Steel		
BONNET		Stainless Steel					Stainless Steel			Stainless Steel			Stainless Steel			Stainless Steel		
STEM		Stainless Steel					Stainless Steel			Stainless Steel			Stainless Steel			Stainless Steel		
DISC		PTFE					Stainless Steel			Stainless Steel			Stainless Steel			Stainless Steel		
		Soft-Seated disc																

Bronze & Brass

Cast Iron

Ductile Iron

Stainless Steel

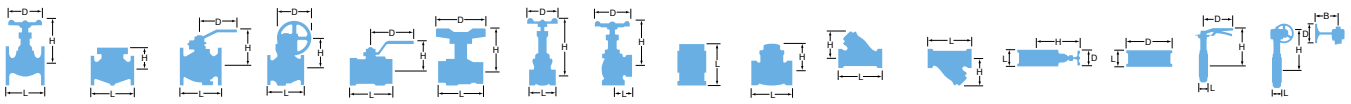
Carbon Steel

Butterfly Valve

Ball Valve

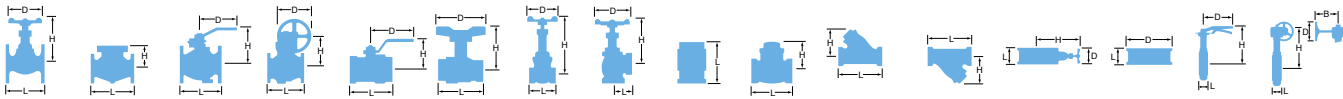
Ball Valve Seal

Actuated Valve



TYPE	A-SERIES GLOBE					A-SERIES GLOBE			A-SERIES GLOBE			A-SERIES GLOBE			A-SERIES GLOBE		
Stainless Steel																	
FIG	10UPA / G-10UPA / 10UPAT					10UPAM / G-10UPAM / 10UPAMT			20UPA / G-20UPA / 20UPAT			20UPAM / G-20UPAM / 20UPAMT			150UPA / G-150UPA / 150UPAT		
PRESSURE	10K					10K			20K			20K			Class 150		
END CONNECTION	JIS B2220					JIS B2220			JIS B2220			JIS B2220			ASME B16.5		
DIMENSIONS	inch	mm	L	H	D	L	H	D	L	H	D	L	H	D	L	H	D
	1/2	15	108	166	90	108	166	90	152	184	100	152	184	100	108	166	90
	3/4	20	117	168	90	117	168	90	178	182	100	178	182	100	117	168	90
	1	25	127	173	100	127	173	100	203	185	100	203	185	100	127	173	100
	1 1/4	32	140	191	120	140	191	120	—	—	—	—	—	—	—	—	—
	1 1/2	40	165	203	140	165	203	140	229	234	160	229	234	160	165	203	140
	2	50	203	234	160	203	234	160	267	286	180	267	286	180	203	234	160
	2 1/2	65	216	247	180	216	247	180	292	295	200	292	295	200	216	247	180
	3	80	241	292	200	241	292	200	318	341	250	318	341	250	241	292	200
	4	100	292	324	225	292	324	225	356	396	300	356	396	300	292	324	225
	5	125	356	381	250	356	381	250	400	492	350	400	492	350	356	381	250
	6	150	406	452	350	406	452	350	444	563	400	444	563	400	406	452	350
	8	200	495	556	400	495	556	400	559	874	500	559	874	500	495	556	400
10	250	622	923	500	622	923	500	622	1048	600	622	1048	600	622	923	500	
12	300	698	1013	500	698	1013	500	—	—	—	—	—	—	698	1013	500	
BODY	Stainless Steel					Stainless Steel			Stainless Steel			Stainless Steel			Stainless Steel		
BONNET	Stainless Steel					Stainless Steel			Stainless Steel			Stainless Steel			Stainless Steel		
STEM	Stainless Steel					Stainless Steel			Stainless Steel			Stainless Steel			Stainless Steel		
DISC	Stainless Steel					Stainless Steel			Stainless Steel			Stainless Steel			Stainless Steel		
	Fig. 10UPAT : Gland Packing / PTFE SIZE.10 & 12 Gear operation type					Fig. 10UPAMT : Gland Packing / PTFE SIZE.10 & 12 Gear operation type			Fig. 20UPAT : Gland Packing / PTFE SIZE.8 & 10 Gear operation type			Fig. 20UPAMT : Gland Packing / PTFE SIZE.8 & 10 Gear operation type			Fig. 150UPAT : Gland Packing / PTFE SIZE.10 & 12 Gear operation type		

TYPE	A-SERIES GLOBE					A-SERIES GLOBE			A-SERIES GLOBE			A-SERIES GLOBE			A-SERIES GLOBE		
Stainless Steel																	
FIG	150UPAM / G-150UPAM / 150UPAMT					300UPA / G-300UPA			300UPAM / G-300UPAM			600UPA			600UPAM		
PRESSURE	Class 150					Class 300			Class 300			Class 600			Class 600		
END CONNECTION	ASME B16.5					ASME B16.5			ASME B16.5			ASME B16.5			ASME B16.5		
DIMENSIONS	inch	mm	L	H	D	L	H	D	L	H	D	L	H	D	L	H	D
	1/2	15	108	166	90	152	184	100	152	184	100	165	212	120	165	212	120
	3/4	20	117	168	90	178	182	100	178	182	100	190	209	120	190	209	120
	1	25	127	173	100	203	185	100	203	185	100	216	245	160	216	245	160
	1 1/2	40	165	203	140	229	234	160	229	234	160	241	282	200	241	282	200
	2	50	203	234	160	267	286	180	267	286	180	292	373	225	292	373	225
	2 1/2	65	216	247	180	292	295	200	292	295	200	330	411	250	330	411	250
	3	80	241	292	200	318	341	250	318	341	250	356	491	350	356	491	350
	4	100	292	324	225	356	396	300	356	396	300	432	584	400	432	584	400
	5	125	356	381	250	400	492	350	400	492	350	—	—	—	—	—	—
	6	150	406	452	350	444	563	400	444	563	400	559	742	600	559	742	600
	8	200	495	556	400	559	874	500	559	874	500	660	875	600	660	875	600
	10	250	622	923	500	622	1048	600	622	1048	600	—	—	—	—	—	—
12	300	698	1013	500	—	—	—	—	—	—	—	—	—	—	—	—	
BODY	Stainless Steel					Stainless Steel			Stainless Steel			Stainless Steel			Stainless Steel		
BONNET	Stainless Steel					Stainless Steel			Stainless Steel			Stainless Steel			Stainless Steel		
STEM	Stainless Steel					Stainless Steel			Stainless Steel			Stainless Steel			Stainless Steel		
DISC	Stainless Steel					Stainless Steel			Stainless Steel			Stainless Steel			Stainless Steel		
	Fig. 150UPAMT : Gland Packing / PTFE SIZE.10 & 12 Gear operation type					SIZE.8 & 10 Gear operation type			SIZE.8 & 10 Gear operation type								



TYPE	AJ-SERIES GLOBE					AJ-SERIES GLOBE			AJ-SERIES GLOBE			AJ-SERIES GLOBE			A-SERIES GLOBE			
Stainless Steel																		
FIG	10UPAJ					20UPAJ			150UPAJ			300UPAJ			10UPAW			
PRESSURE	10K					20K			Class 150			Class 300			10K			
END CONNECTION	JIS B2220					JIS B2220			ASME B16.5			ASME B16.5			JIS B2220			
DIMENSIONS	inch	mm	L	H	D	L	H	D	L	H	D	L	H	D	L	H	D	
	1/2	15	156	186	100	160	186	100	152	186	100	165	186	100	108	166	90	
	3/4	20	156	186	100	160	186	100	152	186	100	165	186	100	117	166	90	
	1	25	190	187	100	194	187	100	190	187	100	203	187	100	127	169	100	
	1 1/2	40	214	236	160	218	236	160	213	236	160	229	236	160	165	201	140	
	2	50	239	237	160	254	289	180	241	237	160	267	289	180	203	231	160	
	2 1/2	65	-	-	-	-	-	-	-	-	-	-	-	-	-	216	244	180
	3	80	280	293	200	302	343	250	292	293	200	318	343	250	241	283	200	
4	100	349	326	225	339	398	300	356	326	225	356	398	300	292	363	225		
5	125	-	-	-	-	-	-	-	-	-	-	-	-	-	356	425	250	
6	150	-	-	-	-	-	-	-	-	-	-	-	-	-	406	482	350	
BODY	Stainless Steel					Stainless Steel			Stainless Steel			Stainless Steel			Stainless Steel			
BONNET	Stainless Steel					Stainless Steel			Stainless Steel			Stainless Steel			Stainless Steel			
STEM	Stainless Steel					Stainless Steel			Stainless Steel			Stainless Steel			Stainless Steel			
DISC	Stainless Steel					Stainless Steel			Stainless Steel			Stainless Steel			Stainless Steel			
	Full Jacketed					Full Jacketed			Full Jacketed			Full Jacketed			Bellows seal globe valve			

TYPE	A-SERIES GLOBE					A-SERIES GLOBE			A-SERIES GLOBE			A-SERIES GLOBE			A-SERIES GLOBE		
Stainless Steel																	
FIG	10UPAWM					20UPAW			20UPAWM			150UPAW			150UPAWM		
PRESSURE	10K					20K			20K			Class 150			Class 150		
END CONNECTION	JIS B2220					JIS B2220			JIS B2220			ASME B16.5			ASME B16.5		
DIMENSIONS	inch	mm	L	H	D	L	H	D	L	H	D	L	H	D	L	H	D
	1/2	15	108	166	90	152	184	100	152	184	100	108	166	90	108	166	90
	3/4	20	117	166	90	178	184	100	178	184	100	117	166	90	117	166	90
	1	25	127	169	100	203	185	100	203	185	100	127	169	100	127	169	100
	1 1/2	40	165	201	140	229	234	160	229	234	160	165	201	140	165	201	140
	2	50	203	231	160	267	287	180	267	287	180	203	231	160	203	231	160
	2 1/2	65	216	244	180	292	293	200	292	293	200	216	244	180	216	244	180
	3	80	241	283	200	318	402	250	318	402	250	241	283	200	241	283	200
4	100	292	363	225	356	453	300	356	453	300	292	363	225	292	363	225	
5	125	356	425	250	400	538	350	400	538	350	356	425	250	356	425	250	
6	150	406	482	350	444	606	400	444	606	400	406	482	350	406	482	350	
BODY	Stainless Steel					Stainless Steel			Stainless Steel			Stainless Steel			Stainless Steel		
BONNET	Stainless Steel					Stainless Steel			Stainless Steel			Stainless Steel			Stainless Steel		
STEM	Stainless Steel					Stainless Steel			Stainless Steel			Stainless Steel			Stainless Steel		
DISC	Stainless Steel					Stainless Steel			Stainless Steel			Stainless Steel			Stainless Steel		
	Bellows seal globe valve					Bellows seal globe valve			Bellows seal globe valve			Bellows seal globe valve			Bellows seal globe valve		

Bronze & Brass

Cast Iron

Ductile Iron

Stainless Steel

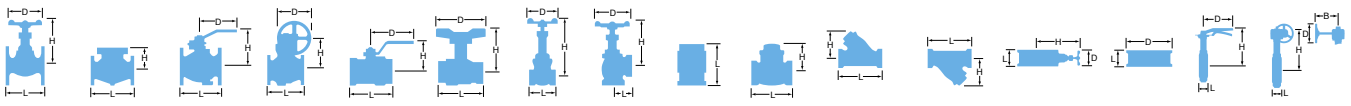
Carbon Steel

Butterfly Valve

Ball Valve

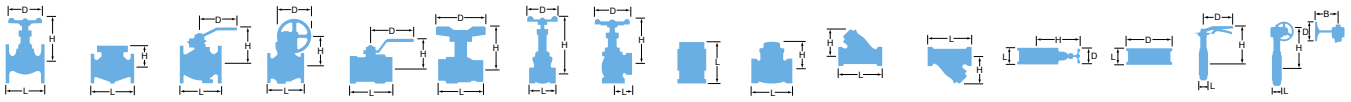
Ball Valve Seal





Actuated Valve








TYPE		A-SERIES GLOBE			A-SERIES GLOBE			B-SERIES LIFT CHECK			B-SERIES SWING CHECK			B-SERIES SWING CHECK			
Stainless Steel																	
FIG		300UPAW			300UPAWM			UN			UO			UOM			
PRESSURE		Class 300			Class 300			10K			10K			10K			
END CONNECTION		ASME B16.5			ASME B16.5			BS21 (JIS B0203)			BS21 (JIS B0203)			BS21 (JIS B0203)			
DIMENSIONS	inch	mm	L	H	D	L	H	D	L	H	D	L	H	D	L	H	D
	3/8	10	—	—	—	—	—	—	55	50	—	—	—	—	—	—	—
	1/2	15	152	184	100	152	184	100	65	53	—	65	45	—	65	45	—
	3/4	20	178	184	100	178	184	100	80	54	—	80	55	—	80	55	—
	1	25	203	185	100	203	185	100	90	62	—	90	61	—	90	61	—
	1 1/4	32	—	—	—	—	—	—	105	66	—	105	71	—	105	71	—
	1 1/2	40	229	234	160	229	234	160	120	76	—	120	72	—	120	72	—
	2	50	267	287	180	267	287	180	140	85	—	140	81	—	140	81	—
	2 1/2	65	292	293	200	292	293	200	—	—	—	180	93	—	180	93	—
	3	80	318	402	250	318	402	250	—	—	—	200	104	—	200	104	—
	4	100	356	453	300	356	453	300	—	—	—	—	—	—	—	—	—
	5	125	400	538	350	400	538	350	—	—	—	—	—	—	—	—	—
	6	150	444	606	400	444	606	400	—	—	—	—	—	—	—	—	—
BODY		Stainless Steel			Stainless Steel			Stainless Steel			Stainless Steel			Stainless Steel			
CAP		—			—			Stainless Steel			Stainless Steel			Stainless Steel			
BONNET		Stainless Steel			Stainless Steel			—			—			—			
STEM		Stainless Steel			Stainless Steel			—			—			—			
DISC		Stainless Steel			Stainless Steel			Stainless Steel			Stainless Steel			Stainless Steel			
HINGE PIN		—			—			—			Stainless Steel			Stainless Steel			
		Bellows seal globe valve			Bellows seal globe valve												

TYPE		B-SERIES SWING CHECK			B-SERIES SWING CHECK			A-SERIES LIFT CHECK			A-SERIES LIFT CHECK			A-SERIES LIFT CHECK			
Stainless Steel																	
FIG		UOB			UOBM			10UNA / 10UNAT			10UNAM / 10UNAMT			20UNA / 20UNAT			
PRESSURE		10K			10K			10K			10K			20K			
END CONNECTION		JIS B2220			JIS B2220			JIS B2220			JIS B2220			JIS B2220			
DIMENSIONS	inch	mm	L	H	D	L	H	D	L	H	D	L	H	D	L	H	D
	1/2	15	85	45	—	85	45	—	108	74	—	108	74	—	152	80	—
	3/4	20	95	55	—	95	55	—	117	76	—	117	76	—	178	78	—
	1	25	110	61	—	110	61	—	127	76	—	127	76	—	203	79	—
	1 1/4	32	130	71	—	130	71	—	140	84	—	140	84	—	—	—	—
	1 1/2	40	150	72	—	150	72	—	165	86	—	165	86	—	229	97	—
	2	50	180	81	—	180	81	—	—	—	—	—	—	—	—	—	—
	2 1/2	65	210	93	—	210	93	—	—	—	—	—	—	—	—	—	—
	3	80	240	104	—	240	104	—	—	—	—	—	—	—	—	—	—
BODY		Stainless Steel			Stainless Steel			Stainless Steel			Stainless Steel			Stainless Steel			
CAP		Stainless Steel			Stainless Steel			—			—			—			
COVER		—			—			Stainless Steel			Stainless Steel			Stainless Steel			
DISC		Stainless Steel			Stainless Steel			Stainless Steel			Stainless Steel			Stainless Steel			
HINGE PIN		Stainless Steel			Stainless Steel			—			—			—			
								Fig. 10UNAT : Gasket / PTFE			Fig. 10UNAMT : Gasket / PTFE			Fig. 20UNAT : Gasket / PTFE			



TYPE	A-SERIES LIFT CHECK					A-SERIES LIFT CHECK					A-SERIES LIFT CHECK					A-SERIES LIFT CHECK					A-SERIES LIFT CHECK				
Stainless Steel																									
FIG	20UNAM / 20UNAMT					150UNA / 150UNAT					150UNAM					300UNA					300UNAM				
PRESSURE	20K					Class 150					Class 150					Class 300					Class 300				
END CONNECTION	JIS B2220					ASME B16.5					ASME B16.5					ASME B16.5					ASME B16.5				
DIMENSIONS		inch	mm	L	H	D	L	H	D	L	H	D	L	H	D	L	H	D	L	H	D				
	1/2	15	152	80	—	108	74	—	108	74	—	152	80	—	152	80	—	152	80	—					
	3/4	20	178	78	—	117	76	—	117	76	—	178	78	—	178	78	—	178	78	—					
	1	25	203	79	—	127	76	—	127	76	—	203	79	—	203	79	—	203	79	—					
1 1/2	40	229	97	—	165	86	—	165	86	—	229	97	—	229	97	—	229	97	—						
BODY	Stainless Steel					Stainless Steel					Stainless Steel					Stainless Steel					Stainless Steel				
COVER	Stainless Steel					Stainless Steel					Stainless Steel					Stainless Steel					Stainless Steel				
DISC	Stainless Steel					Stainless Steel					Stainless Steel					Stainless Steel					Stainless Steel				
	Fig. 20UNAMT : Gasket / PTFE					Fig. 150UNAT : Gasket / PTFE					Fig. 10UOAT : Gasket / PTFE														

TYPE	A-SERIES SWING CHECK					A-SERIES SWING CHECK					A-SERIES SWING CHECK					A-SERIES SWING CHECK					A-SERIES SWING CHECK				
Stainless Steel																									
FIG	10UOAT / 10UOAT					10UOAM / 10UOAMT					20UOAT / 20UOAT					20UOAM / 20UOAMT					150UOAT / 150UOAT				
PRESSURE	10K					10K					20K					20K					Class 150				
END CONNECTION	JIS B2220					JIS B2220					JIS B2220					JIS B2220					ASME B16.5				
DIMENSIONS		inch	mm	L	H	D	L	H	D	L	H	D	L	H	D	L	H	D	L	H	D				
	1 1/2	40	165	111	—	165	111	—	241	121	—	241	121	—	165	111	—								
	2	50	203	121	—	203	121	—	267	143	—	267	143	—	203	121	—								
	2 1/2	65	216	134	—	216	134	—	292	163	—	292	163	—	216	134	—								
	3	80	241	148	—	241	148	—	318	178	—	318	178	—	241	148	—								
	4	100	292	162	—	292	162	—	356	201	—	356	201	—	292	162	—								
	5	125	330	192	—	330	192	—	400	231	—	400	231	—	330	192	—								
	6	150	356	217	—	356	217	—	444	259	—	444	259	—	356	217	—								
	8	200	495	264	—	495	264	—	533	292	—	533	292	—	495	264	—								
	10	250	622	287	—	622	287	—	622	356	—	622	356	—	622	287	—								
	12	300	698	315	—	698	315	—	711	373	—	711	373	—	698	315	—								
14	350	787	363	—	787	363	—	—	—	—	—	—	—	787	363	—									
16	400	864	407	—	864	407	—	—	—	—	—	—	—	864	407	—									
BODY	Stainless Steel					Stainless Steel					Stainless Steel					Stainless Steel					Stainless Steel				
COVER	Stainless Steel					Stainless Steel					Stainless Steel					Stainless Steel					Stainless Steel				
DISC	Stainless Steel					Stainless Steel					Stainless Steel					Stainless Steel					Stainless Steel				
HINGE PIN	Stainless Steel					Stainless Steel					Stainless Steel					Stainless Steel					Stainless Steel				
	Fig. 10UOAT : Gasket / PTFE					Fig. 10UOAMT : Gasket / PTFE					Fig. 20UOAT : Gasket / PTFE					Fig. 10UOAMT : Gasket / PTFE					Fig. 20UOAT : Gasket / PTFE				

Bronze & Brass

Cast Iron

Ductile Iron

Stainless Steel

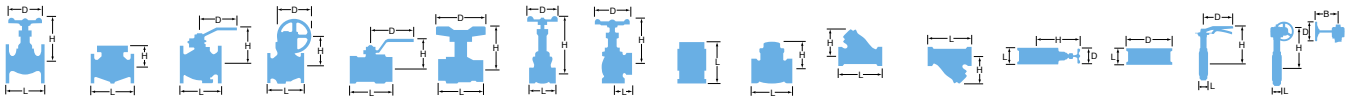
Carbon Steel

Butterfly Valve

Ball Valve

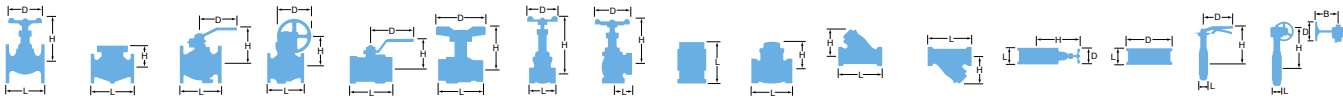
Ball Valve Seal

Actuated Valve



TYPE		A-SERIES SWING CHECK					A-SERIES SWING CHECK					A-SERIES SWING CHECK					A-SERIES SWING CHECK					A-SERIES SWING CHECK				
Stainless Steel																										
FIG		150UOAM / 150UOAMT					300UOA					300UOAM					600UOA					600UOAM				
PRESSURE		Class 150					Class 300					Class 300					Class 600					Class 600				
END CONNECTION		ASME B16.5					ASME B16.5					ASME B16.5					ASME B16.5					ASME B16.5				
DIMENSIONS		inch	mm	L	H	D	L	H	D	L	H	D	L	H	D	L	H	D	L	H	D	L	H	D		
1/2		15	—	—	—	—	—	—	—	—	—	—	165	90	—	165	90	—	165	90	—	165	90	—		
3/4		20	—	—	—	—	—	—	—	—	—	—	190	96	—	190	96	—	190	96	—	190	96	—		
1		25	—	—	—	—	—	—	—	—	—	—	216	109	—	216	109	—	216	109	—	216	109	—		
1 1/2		40	165	111	—	241	121	—	241	121	—	241	126	—	241	126	—	241	126	—	241	126	—	241		
2		50	203	121	—	267	143	—	267	143	—	267	143	—	292	202	—	292	202	—	292	202	—	292		
2 1/2		65	216	134	—	292	163	—	292	163	—	292	163	—	330	213	—	330	213	—	330	213	—	330		
3		80	241	148	—	318	178	—	318	178	—	318	178	—	356	239	—	356	239	—	356	239	—	356		
4		100	292	162	—	356	201	—	356	201	—	356	201	—	432	279	—	432	279	—	432	279	—	432		
5		125	330	192	—	400	231	—	400	231	—	400	231	—	—	—	—	—	—	—	—	—	—	—		
6		150	356	217	—	444	259	—	444	259	—	444	259	—	559	339	—	559	339	—	559	339	—	559		
8		200	495	264	—	533	292	—	533	292	—	533	292	—	660	414	—	660	414	—	660	414	—	660		
10		250	622	287	—	622	356	—	622	356	—	622	356	—	787	430	—	787	430	—	787	430	—	787		
12		300	698	315	—	711	373	—	711	373	—	711	373	—	838	477	—	838	477	—	838	477	—	838		
14		350	787	363	—	—	—	—	—	—	—	—	—	—	—	—	—	—	—	—	—	—	—	—		
16		400	864	407	—	—	—	—	—	—	—	—	—	—	—	—	—	—	—	—	—	—	—	—		
BODY		Stainless Steel					Stainless Steel					Stainless Steel					Stainless Steel					Stainless Steel				
COVER		Stainless Steel					Stainless Steel					Stainless Steel					Stainless Steel					Stainless Steel				
DISC		Stainless Steel					Stainless Steel					Stainless Steel					Stainless Steel					Stainless Steel				
HINGE PIN		Stainless Steel					Stainless Steel					Stainless Steel					Stainless Steel					Stainless Steel				
		Fig. 150UOAMT : Gasket / PTFE																								

TYPE		WAFER CHECK					WAFER CHECK					
Stainless Steel												
FIG		10UW					10UWS					
PRESSURE		10K					10K					
END CONNECTION		Wafer Type					Wafer Type					
DIMENSIONS		inch	mm	L	H	D	L	H	D	L	H	D
2		50	60	147	60	60	60	147	60	60	147	60
2 1/2		65	67	155	60	67	67	155	60	67	155	60
3		80	73	163	60	73	73	163	60	73	163	60
4		100	73	175	60	73	73	175	60	73	175	60
5		125	89	189	70	89	89	189	70	89	189	70
6		150	98	202	70	98	98	202	70	98	202	70
8		200	127	229	70	127	127	229	70	127	229	70
10		250	146	280	90	146	146	280	90	146	280	90
12		300	181	307	90	181	181	307	90	181	307	90
BODY		Stainless Steel+NBR					Stainless Steel					
BONNET		Stainless Steel					Stainless Steel					
STEM		Stainless Steel					Stainless Steel					
DISC		Stainless Steel					Stainless Steel					
HINGE PIN		Stainless Steel					Stainless Steel					



TYPE	AJ-SERIES LIFT CHECK					AJ-SERIES LIFT CHECK			AJ-SERIES LIFT CHECK			AJ-SERIES LIFT CHECK			AJ-SERIES LIFT CHECK		
Stainless Steel																	
FIG	10UNAJ					10UNAJM			20UNAJ			150UNAJ			300UNAJ		
PRESSURE	10K					10K			20K			Class 150			Class 300		
END CONNECTION	JIS B2220					JIS B2220			JIS B2220			ASME B16.5			ASME B16.5		
DIMENSIONS	inch	mm	L	H	D	L	H	D	L	H	D	L	H	D	L	H	D
	1/2	15	156	78	—	156	78	—	160	78	—	152	78	—	165	78	—
	3/4	20	156	76	—	156	76	—	160	76	—	152	76	—	165	76	—
	1	25	190	77	—	190	77	—	194	77	—	190	77	—	203	77	—
	1 1/2	40	214	102	—	214	102	—	218	102	—	213	102	—	229	102	—
BODY	Stainless Steel					Stainless Steel			Stainless Steel			Stainless Steel			Stainless Steel		
COVER	Stainless Steel					Stainless Steel			Stainless Steel			Stainless Steel			Stainless Steel		
DISC	Stainless Steel					Stainless Steel			Stainless Steel			Stainless Steel			Stainless Steel		
	Full Jacketed					Full Jacketed			Full Jacketed			Full Jacketed			Full Jacketed		

TYPE	AJ-SERIES SWING CHECK					AJ-SERIES SWING CHECK			AJ-SERIES SWING CHECK			AJ-SERIES SWING CHECK		
Stainless Steel														
FIG	10UOAJ					20UOAJ			150UOAJ			300UOAJ		
PRESSURE	10K					20K			Class 150			Class 300		
END CONNECTION	JIS B2220					JIS B2220			ASME B16.5			ASME B16.5		
DIMENSIONS	inch	mm	L	H	D	L	H	D	L	H	D	L	H	D
	2	50	239	125	—	254	150	—	241	125	—	267	150	—
	3	80	280	152	—	314	179	—	292	152	—	330	179	—
	4	100	349	169	—	383	203	—	356	169	—	400	203	—
	6	150	393	219	—	421	262	—	406	219	—	444	262	—
BODY	Stainless Steel					Stainless Steel			Stainless Steel			Stainless Steel		
COVER	Stainless Steel					Stainless Steel			Stainless Steel			Stainless Steel		
DISC	Stainless Steel					Stainless Steel			Stainless Steel			Stainless Steel		
HINGE PIN	Stainless Steel					Stainless Steel			Stainless Steel			Stainless Steel		
	Full Jacketed					Full Jacketed			Full Jacketed			Full Jacketed		

Bronze & Brass

Cast Iron

Ductile Iron

Stainless Steel

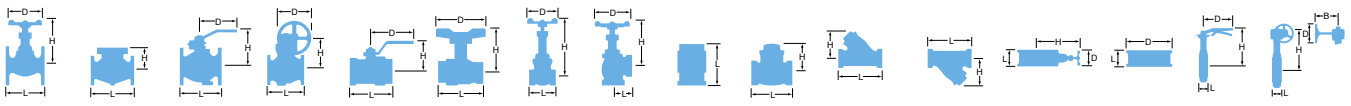
Carbon Steel

Butterfly Valve

Ball Valve

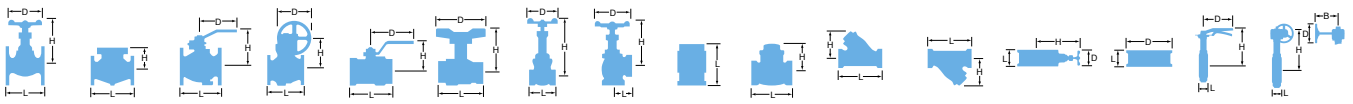
Ball Valve Seal

Actuated Valve



TYPE		BALL CHECK			BALL CHECK			B-SERIES Y TYPE STRAINER			B-SERIES Y TYPE STRAINER			B-SERIES Y TYPE STRAINER		
Stainless Steel																
FIG		10UFT			10UFTE			UY			UYM			UYB		
PRESSURE		10K			10K			20K			20K			10K		
END CONNECTION		JIS B2220			JIS B2220			BS21 (JIS B0203)			BS21 (JIS B0203)			JIS B2220		
DIMENSIONS		inch	mm	L	H	D	L	H	D	L	H	D	L	H	D	
Stainless Steel	1/4	8	—	—	—	—	—	—	—	65	50	—	65	50	—	
	3/8	10	—	—	—	—	—	—	—	70	50	—	70	50	—	
	1/2	15	—	—	—	—	—	—	—	85	60	—	85	60	—	
	3/4	20	—	—	—	—	—	—	—	100	65	—	100	65	—	
	1	25	—	—	—	—	—	—	—	115	77	—	115	77	—	
	1 1/4	32	—	—	—	—	—	—	—	135	90	—	135	90	—	
	1 1/2	40	190	87	—	—	—	—	—	150	100	—	150	100	—	
	2	50	200	100.5	—	200	97	—	180	115	—	180	115	—	220	122
	2 1/2	65	220	123.5	—	220	120.5	—	220	150	—	220	150	—	—	—
	3	80	240	150	—	240	146	—	250	193	—	250	193	—	—	—
	4	100	290	187	—	290	187	—	—	—	—	—	—	—	—	—
	6	150	410	275	—	410	275	—	—	—	—	—	—	—	—	—
8	200	—	—	—	500	366	—	—	—	—	—	—	—	—	—	
BODY		Stainless Steel			Stainless Steel			Stainless Steel			Stainless Steel			Stainless Steel		
COVER		Stainless Steel			Stainless Steel			—			—			—		
CAP		—			—			Stainless Steel			Stainless Steel			Stainless Steel		
DISC		NBR			NBR			—			—			—		
SCREEN		—			—			Stainless Steel			Stainless Steel			Stainless Steel		

TYPE		B-SERIES Y TYPE STRAINER			A-SERIES Y TYPE STRAINER			A-SERIES Y TYPE STRAINER			A-SERIES Y TYPE STRAINER		
Stainless Steel													
FIG		UYBM			10UYA			10UYAM			20UYA		
PRESSURE		10K			10K			10K			20K		
END CONNECTION		JIS B2220			JIS B2220			JIS B2220			JIS B2220		
DIMENSIONS		inch	mm	L	H	D	L	H	D	L	H	D	
Stainless Steel	3/8	10	110	50	—	—	—	—	—	—	—	—	
	1/2	15	120	58	—	—	—	—	—	160	70	—	
	3/4	20	130	66	—	—	—	—	—	160	80	—	
	1	25	150	78	—	—	—	—	—	190	92	—	
	1 1/4	32	170	93	—	—	—	—	—	—	—	—	
	1 1/2	40	190	104	—	—	—	—	—	240	125	—	
	2	50	220	122	—	—	—	—	—	250	150	—	
	2 1/2	65	—	—	—	270	160	—	—	270	160	—	
	3	80	—	—	—	290	197	—	—	290	197	—	
	4	100	—	—	—	350	233	—	—	350	233	—	
	5	125	—	—	—	390	267	—	—	390	267	—	
	6	150	—	—	—	440	320	—	—	440	320	—	
8	200	—	—	—	540	380	—	—	540	380	—		
10	250	—	—	—	760	538	—	—	760	538	—		
12	300	—	—	—	870	635	—	—	870	635	—		
BODY		Stainless Steel			Stainless Steel			Stainless Steel			Stainless Steel		
CAP		Stainless Steel			—			—			—		
COVER		—			Stainless Steel			Stainless Steel			Stainless Steel		
SCREEN		Stainless Steel			Stainless Steel			Stainless Steel			Stainless Steel		



TYPE		NEEDLE				NEEDLE				NEEDLE				NEEDLE				NEEDLE			
mm., Series																					
FIG		UN3-AP-				UN3-BP-				UN3-CP-				UN3-DP-				UN3-EP-			
PRESSURE		30K				30K				30K				30K				30K			
END CONNECTION		BS21 (JIS B0203)				BS21 (JIS B0203)				COUPLE LOK				COUPLE LOK				JIS B0203 / COUPLE LOK			
DIMENSIONS	mm	L	H	D	L	H	D	L	H	D	L	H	D	L	H	D	L	H	D		
	6	40	59	40	15	59	40	60.8	59	40	30.4	59	40	55.4	59	40	55.4	59	40		
	8	40	59	40	15	59	40	60.8	59	40	30.4	59	40	55.4	59	40	55.4	59	40		
	10	45	64	40	18	64	40	62.4	64	40	—	—	—	56.2	64	40	56.2	64	40		
	12	—	—	—	—	—	—	—	—	—	—	—	—	—	—	—	—	—	—	—	
	12	55	79	50	—	—	—	70.2	64	40	—	—	—	60.1	64	40	60.1	64	40		
12	—	—	—	—	—	—	—	—	—	—	—	—	—	—	—	—	60.1	64	40		
BODY		Stainless Steel				Stainless Steel				Stainless Steel				Stainless Steel				Stainless Steel			
STEM		Stainless Steel				Stainless Steel				Stainless Steel				Stainless Steel				Stainless Steel			
FIG		Rc1/8": UN3-AP-1 Rc1/4": UN3-AP-2 Rc3/8": UN3-AP-3 Rc1/2": UN3-AP-4				Rc1/8": UN3-BP-1 Rc1/4": UN3-BP-2 Rc3/8": UN3-BP-3				6mm : UN3-CP-6 8mm : UN3-CP-8 10mm : UN3-CP-10 12mm : UN3-CP-12				6mm : UN3-DP-6 8mm : UN3-DP-8				6mm x R1/8" : UN3-EP-6-2 8mm x R1/8" : UN3-EP-8-2 10mm x R1/8" : UN3-EP-10-2 10mm x R3/8" : UN3-EP-10-3 12mm x R1/8" : UN3-EP-12-2 12mm x R3/8" : UN3-EP-12-3			

TYPE		NEEDLE				NEEDLE				NEEDLE				NEEDLE			
mm., Series																	
FIG		UN3-FP-				UN26-AP-				UN26-CP-				UN26-SP-			
PRESSURE		30K				260K				260K				260K			
END CONNECTION		JIS B0203 / COUPLE LOK				BS21 (JIS B0203)				COUPLE LOK				JIS B2316			
DIMENSIONS	mm	L	H	D	L	H	D	L	H	D	L	H	D	L	H	D	
	6	30.4	59	40	48	69	40	64.8	69	40	60	69	40	60	69	40	
	8	30.4	59	40	48	69	40	64.8	69	40	60	69	40	60	69	40	
	10	31.2	64	40	55	81	70	68.4	83	50	65	81	70	—	—	—	
	12	35.1	64	40	—	—	—	74.7	83	50	—	—	—	—	—	—	
	15	—	—	—	60	86	70	—	—	—	75	86	70	—	—	—	
	20	—	—	—	70	99	85	—	—	—	85	99	85	—	—	—	
25	—	—	—	85	119	85	—	—	—	100	119	85	—	—	—		
BODY		Stainless Steel				Stainless Steel				Stainless Steel				Stainless Steel			
STEM		Stainless Steel				Stainless Steel				Stainless Steel				Stainless Steel			
FIG		6mm x R1/4" : UN3-FP-6-2 8mm x R1/4" : UN3-FP-8-2 10mm x R1/4" : UN3-FP-10-2 10mm x R3/8" : UN3-FP-10-3 12mm x R1/4" : UN3-FP-12-2 12mm x R3/8" : UN3-FP-12-3				Rc1/8" : UN26-AP-1 Rc1/4" : UN26-AP-2 Rc3/8" : UN26-AP-3 Rc1/2" : UN26-AP-4 Rc3/4" : UN26-AP-6 Rc1" : UN26-AP-8				6mm : UN26-CP-6 8mm : UN26-CP-8 10mm : UN26-CP-10 12mm : UN26-CP-12				1/8" : UN26-SP-1 1/4" : UN26-SP-2 3/8" : UN26-SP-3 1/2" : UN26-SP-4 3/4" : UN26-SP-6 1" : UN26-SP-8			

TYPE		NEEDLE				NEEDLE				NEEDLE				NEEDLE				NEEDLE			
Inch Series																					
FIG		UN3-CP-				UN3-DP-				UN3-EP-				UN3-FP-				UN26-CP-			
PRESSURE		30K				30K				30K				30K				260K			
END CONNECTION		COUPLE LOK				COUPLE LOK				JIS B0203 / COUPLE LOK				JIS B0203 / COUPLE LOK				COUPLE LOK			
DIMENSIONS	inch	mm	L	H	D	L	H	D	L	H	D	L	H	D	L	H	D				
	1/4	8	60.8	59	40	30.4	59	40	55.4	59	40	30.4	59	40	64.8	69	40				
	3/8	10	62.4	64	40	—	—	—	56.2	64	40	31.2	64	40	68.4	83	50				
	1/2	15	70.2	64	40	—	—	—	60.1	64	40	35.1	64	40	74.7	83	50				
BODY		Stainless Steel				Stainless Steel				Stainless Steel				Stainless Steel				Stainless Steel			
STEM		Stainless Steel				Stainless Steel				Stainless Steel				Stainless Steel				Stainless Steel			
FIG		1/4": UN3-CP-02 3/8": UN3-CP-03 1/2": UN3-CP-04				1/4": UN3-DP-02				1/4": UN3-EP-02-2 3/8": UN3-EP-03-2 3/8": UN3-EP-03-3 1/2": UN3-EP-04-2 1/2": UN3-EP-04-3				1/4": UN3-FP-02-2 3/8": UN3-FP-03-2 3/8": UN3-FP-03-3 1/2": UN3-FP-04-2 1/2": UN3-FP-04-3				1/4": UN26-CP-02 3/8": UN26-CP-03 1/2": UN26-CP-04			

Brass & Bronze

Cast Iron

Ductile Iron

Stainless Steel

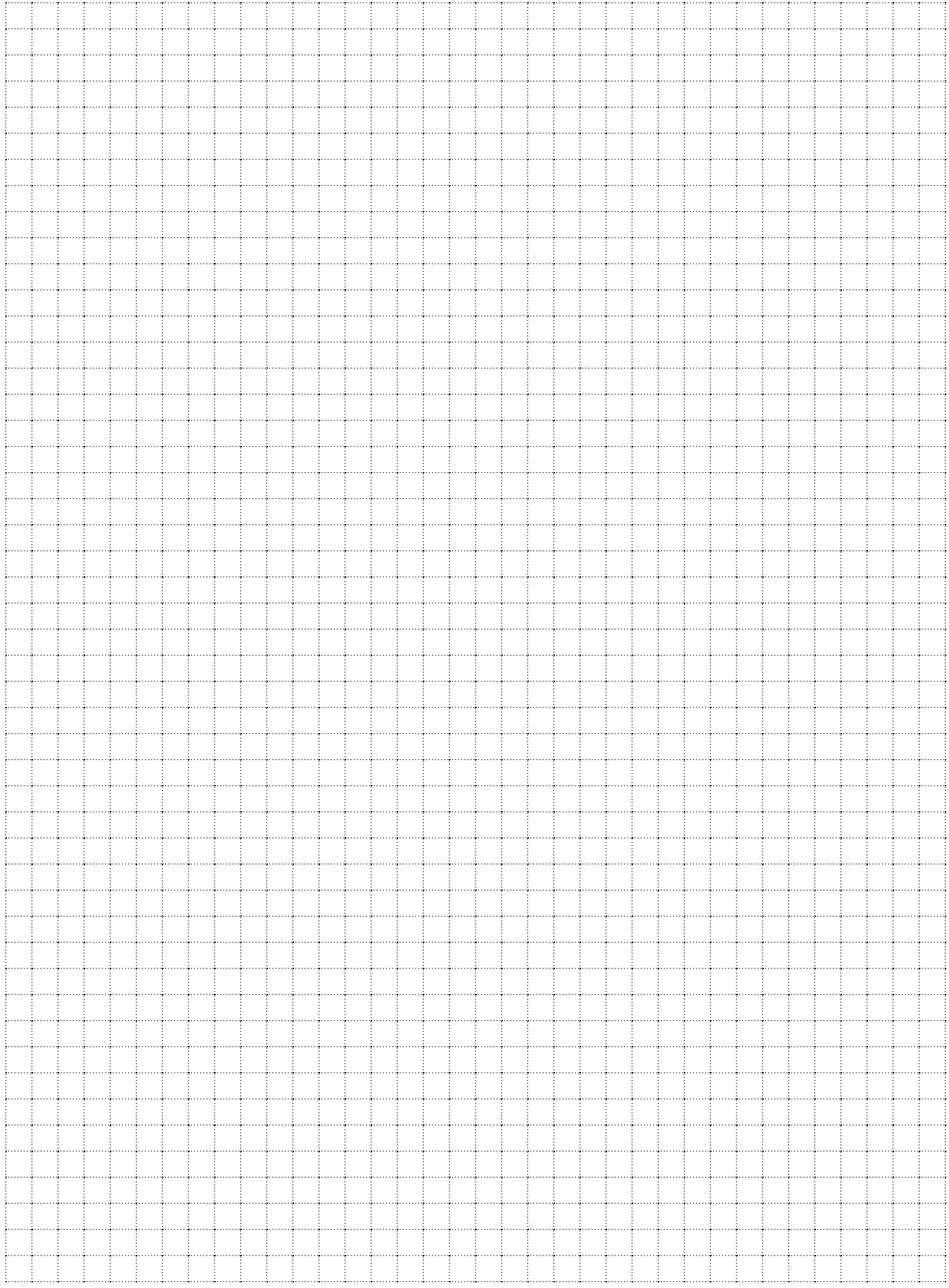
Carbon Steel

Butterfly Valve

Ball Valve

Ball Valve Seal

Actuated Valve



CARBON STEEL

Carbon Steel

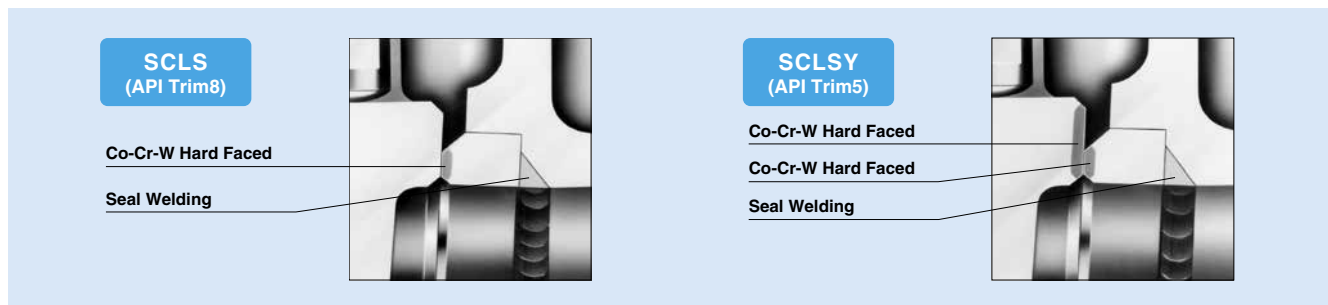
General Design Specifications

Items	American Std.	British Std.
Shell wall thickness and general valve design	API 600	BS 1414 (Gate valve) BS 1873 (Globe valve) BS 1868 (Check valve)
Pressure-temperature ratings	ASME B16.34	BS 1560
Face to face dimensions End to end dimensions	ASME B16.10	BS 2080
End flange dimensions Gasket contact facing	ASME B16.5*	BS 1560
Welding end dimensions	ASME B16.25	BS 1414 (Gate valve) BS 1873 (Globe valve) BS 1868 (Check valve)

*MSS SP-44 for Nominal size 22" and ASME B16.47 Series B for Nominal size 26" and larger, for end flange dimensions.

Mounting of Body Seat Rings

Body seat rings of KITZ cast steel valves are mounted on the valve body by seal welding, as shown in the typical examples of gate valves illustrated below. Unless specifically requested in advance, mounting of body seat rings shall be performed at the manufacturer's discretion. Specify your own method of mounting, noting your purchase orders with the appropriate KITZ product code numbers.



For KITZ cast steel valves made of ASTM A216 WCB, the standard shell material, disc seats, and body seat rings shall be provided as follows. (Refer to Page 45 for Product Coding)

KITZ Product Code	Standard Disc Seat	Standard Body Seat	Mounting of Body Seat Rings
SCLS (Gate) SCJS (Globe) SCOS (Check)	F6a or WCB + 13Cr or A105 + 13Cr or CA15	A105 + HF* or A106 Gr. B + HF* or AISI 1022 + HF* or Direct HF**	Seal Welded or Direct HF**
SCLSY (Gate) SCJSY (Globe) SCOSY (Check)	A105 + HF* or WCB + HF* or CA15 + HF*	A105 + HF* or A106 Gr. B + HF* or AISI 1022 + HF* or Direct HF**	Seal Welded or Direct HF**

* Co-Cr-W Alloy deposited for hard facing.

** Co-Cr-W Alloy is directly deposited on valve body for hard facing.

KITZ Product Code 900SCJS, 900SCJSY, 1500SCJS, 1500SCJSY, 2500SCJS and 2500SCJSY globe valves employ this hard facing.

Bonnet Gasket Materials

Depending on the class ratings and servicing conditions, the following gasket materials are available for the body/bonnet flange gaskets of KITZ cast steel valves. Specify your gasket material in the purchase order.

Gasket Material	Class					
	150	300	600	900	1500	2500
Corrugated metal with flexible graphite	●					
Ring joint metal				●	●	●
Spiral wound metal, flexible graphite filled		●	●			
Stainless steel inserted flexible graphite	●					

Please refer to our website (www.kitz.co.jp) or contact KITZ for details.

Product Coding

G- 150 SC LS6CY

5 4 1 2 3

1 ASME pressure class:
150 through 2500

2 Shell material code:
Carbon and low alloy steel are always identified as "SC"

3 Other valve specifications:

L S 6C Y

a b c b

a Valve type code:
L... Gate valve
J... Globe valve
O... Swing check valve

b Seat material/mounting:

Code	Disc Seat Material	Body Seat Material	Type of Mounting
S□	13Cr	HF	Refer to Page 44
S□Y	HF	HF	

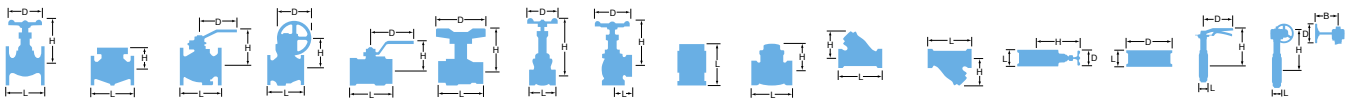
□: Special shell material code

c Special shell material:
No code is required for WCB.

4 Type of end connection:
No code is required for RF-flanged ends
W... Butt-welding ends.

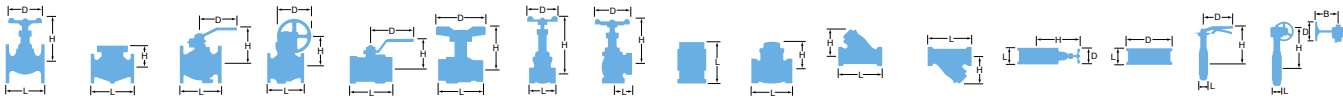
5 Type of valve operation:
No code is required for manual handwheel operation.
G ... Gear operation.
E ... Electric actuator operation.

Please refer to our website (www.kitz.co.jp) or contact KITZ for details.



TYPE	GATE					GATE			GATE			GATE			GLOBE		
Carbon Steel																	
FIG	10SCLS					20SCLS			150SCLS			300SCLS			10SCJS / G-10SCJS		
PRESSURE	10K					20K			Class 150			Class 300			10K		
END CONNECTION	JIS B2220					JIS B2220			ASME B16.5			ASME B16.5			JIS B2220		
DIMENSIONS	inch	mm	L	H	D	L	H	D	L	H	D	L	H	D	L	H	D
	1½	40	—	—	—	—	—	—	165	385	200	190	413	200	—	—	—
	2	50	178	385	200	216	413	200	178	385	200	216	413	200	203	331	200
	2½	65	190	432	200	241	456	200	190	432	200	241	456	200	216	379	250
	3	80	203	509	250	283	530	250	203	509	250	283	530	250	241	389	250
	4	100	229	592	250	305	618	250	229	592	250	305	618	250	292	458	250
	5	125	254	658	300	381	694	300	254	658	300	381	694	300	356	484	300
	6	150	267	758	300	403	793	350	267	758	300	403	793	350	406	513	350
	8	200	292	958	350	419	1014	400	292	959	350	419	1014	400	495	929	500
	10	250	330	1162	400	457	1216	450	330	1162	400	457	1216	450	622	975	500
	12	300	356	1362	450	502	1458	600	356	1362	450	502	1458	600	698	1049	500
	14	350	381	1572	600	762	1563	600	381	1572	600	762	1563	600	—	—	—
	16	400	406	1692	600	838	1766	680	406	1692	600	838	1766	680	—	—	—
	18	450	432	1888	600	914	1932	680	432	1888	680	914	1932	680	—	—	—
	20	500	457	2123	680	991	2137	760	457	2123	680	991	2137	760	—	—	—
	24	600	508	2497	760	1143	2542	910	508	2498	760	1143	2542	910	—	—	—
BODY	Cast Steel					Cast Steel			Cast Steel			Cast Steel			Cast Steel		
BONNET	Cast Steel					Cast Steel			Cast Steel			Cast Steel			Cast Steel		
STEM	Stainless Steel					Stainless Steel			Stainless Steel			Stainless Steel			Stainless Steel		
DISC	Stainless Steel / Cast Steel					Stainless Steel / Cast Steel			Stainless Steel / Cast Steel			Stainless Steel / Cast Steel			Stainless Steel / Cast Steel / Carbon Steel		
															SIZE.8 to 12 Gear operation type		

TYPE	GLOBE					GLOBE			GLOBE			SWING CHECK			SWING CHECK		
Carbon Steel																	
FIG	20SCJS / G-20SCJS					150SCJS / G-150SCJS			300SCJS / G-300SCJS			10SCOS			20SCOS		
PRESSURE	20K					Class 150			Class 300			10K			20K		
END CONNECTION	JIS B2220					ASME B16.5			ASME B16.5			JIS B2220			JIS B2220		
DIMENSIONS	inch	mm	L	H	D	L	H	D	L	H	D	L	H	D	L	H	D
	1½	40	—	—	—	165	331	200	229	361	200	—	—	—	—	—	—
	2	50	267	361	200	203	331	200	267	361	200	203	156	—	267	164	—
	2½	65	292	428	250	216	379	250	292	428	250	216	168	—	292	190	—
	3	80	318	436	250	241	389	250	318	436	250	241	185	—	318	205	—
	4	100	356	509	350	292	458	250	356	509	350	292	210	—	356	230	—
	5	125	400	610	400	356	484	300	400	610	400	330	239	—	400	250	—
	6	150	444	989	500	406	513	350	444	989	500	356	250	—	444	280	—
	8	200	559	1064	500	495	929	500	559	1064	500	495	293	—	533	330	—
	10	250	622	1142	600	622	975	500	622	1142	600	622	340	—	622	370	—
	12	300	711	1187	600	698	1049	500	711	1187	600	698	375	—	711	415	—
	14	350	—	—	—	—	—	—	—	—	—	787	415	—	838	491	—
	16	400	—	—	—	—	—	—	—	—	—	864	455	—	864	543	—
	18	450	—	—	—	—	—	—	—	—	—	978	508	—	978	584	—
	20	500	—	—	—	—	—	—	—	—	—	978	585	—	1016	645	—
	24	600	—	—	—	—	—	—	—	—	—	1295	670	—	1346	865	—
BODY	Cast Steel					Cast Steel			Cast Steel			Cast Steel			Cast Steel		
BONNET	Cast Steel					Cast Steel			Cast Steel			—			—		
COVER	—					—			—			Cast Steel / Carbon Steel			Cast Steel / Carbon Steel		
STEM	Stainless Steel					Stainless Steel			Stainless Steel			—			—		
HINGE PIN	—					—			—			Stainless Steel			Stainless Steel		
DISC	Stainless Steel / Cast Steel / Carbon Steel					Stainless Steel / Cast Steel / Carbon Steel			Stainless Steel / Cast Steel / Carbon Steel			Stainless Steel / Cast Steel			Stainless Steel / Cast Steel		
	SIZE.6 to 12 Gear operation type					SIZE.8 to 12 Gear operation type			SIZE.6 to 12 Gear operation type								



TYPE		SWING CHECK				SWING CHECK			
Carbon Steel									
FIG		150SCOS				300SCOS			
PRESSURE		Class 150				Class 300			
END CONNECTION		ASME B16.5				ASME B16.5			
DIMENSIONS	inch	mm	L	H	D	L	H	D	
	1½	40	165	132	—	241	155	—	
	2	50	203	156	—	267	164	—	
	2½	65	216	168	—	292	190	—	
	3	80	241	185	—	318	205	—	
	4	100	292	210	—	356	230	—	
	5	125	330	239	—	400	250	—	
	6	150	356	250	—	444	280	—	
	8	200	495	293	—	533	330	—	
	10	250	622	340	—	622	370	—	
	12	300	698	375	—	711	415	—	
	14	350	787	415	—	838	491	—	
	16	400	864	455	—	864	543	—	
	18	450	978	508	—	978	584	—	
	20	500	978	585	—	1016	645	—	
	24	600	1295	670	—	1346	865	—	
BODY		Cast Steel				Cast Steel			
COVER		Cast Steel / Carbon Steel				Cast Steel / Carbon Steel			
HINGE PIN		Stainless Steel				Stainless Steel			
DISC		Stainless Steel / Cast Steel				Stainless Steel / Cast Steel			
		API 594 type B with internal hinge pin design can be available.				API 594 type B with internal hinge pin design can be available.			

Bronze & Brass

Cast Iron

Ductile Iron

Stainless Steel

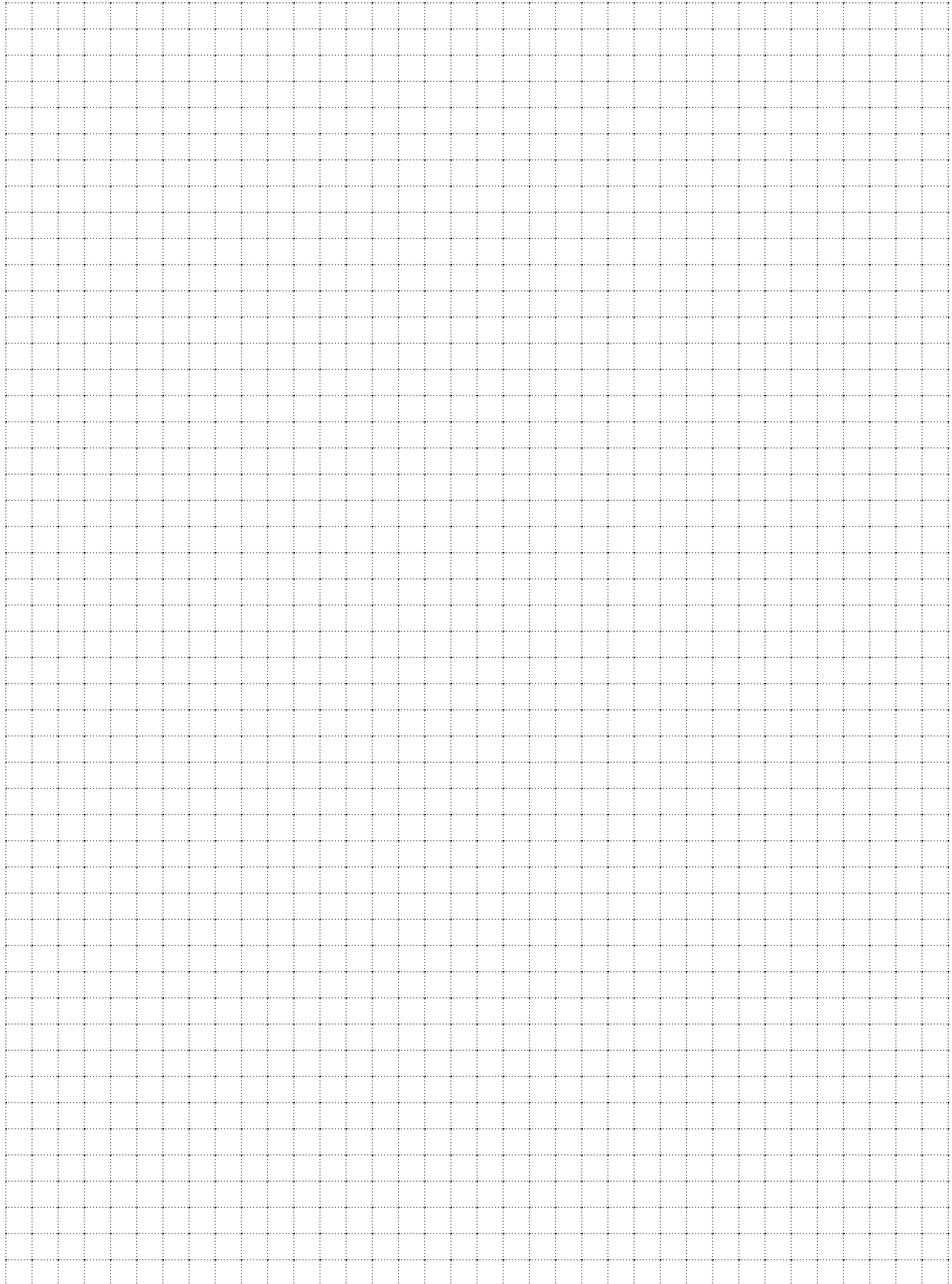
Carbon Steel

Butterfly Valve

Ball Valve

Ball Valve Seat

Actuated Valve



BUTTERFLY VALVE

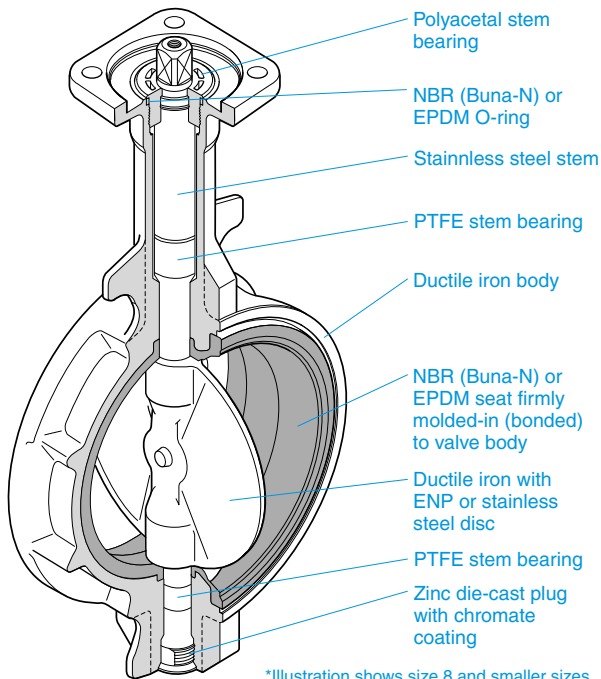
Butterfly Valve

KITZ DJ Series Butterfly Valves

Thorough pursuit of functions required for butterfly valves
 Variety of product ranges to comply with customers' requirements

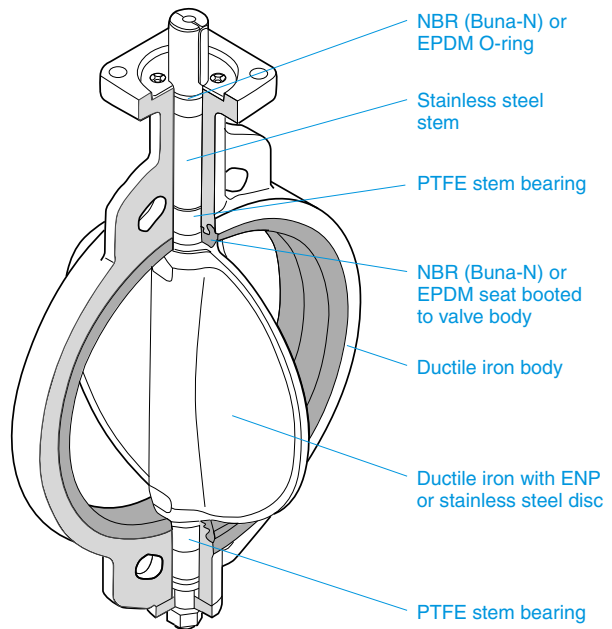
Design Features

Molded-in (bonded) seat structure (Size 2^B to 12^B)

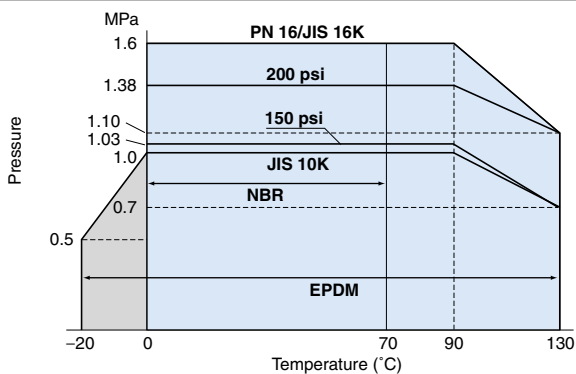


*Illustration shows size 8 and smaller sizes

Replaceable seat structure (Size 14^B to 24^B)

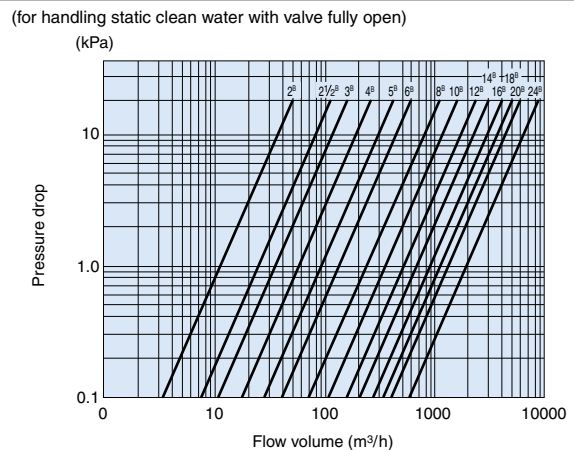


P-T Rating



Notes1: There are some fluid type restrictions for the service at 130°C. Contact KITZ for the details.
Notes2: P-T rating for sub-zero application is optionally available. Contact KITZ for technical advice when service conditions may exceed the P-T rating range limited here.

Pressure Loss



Technical Specifications

Maximum Service Pressure

ASME 150 psi	1.03 MPa
ASME 200 psi	1.38 MPa
BS PN16	1.6 MPa
JIS 10K	1.0 MPa
JIS 16K	1.6 MPa

Body Material

Ductile iron	ASTM A536 Gr. 65-45-12 *1
--------------	---------------------------

*1 JIS 10K design, size 14B and larger: Cast iron ASTM A126 Class B

Service Temperature Range

NBR (Buna-N) seat	0°C to +70°C
EPDM seat	-20°C to +130°C *2
Continuous service temperature range	0°C to +100°C

*2 There are some fluid type restrictions for the service at 130°C. Contact KITZ for the details.

Applicable Standards

Valve design	API 609, MSS-SP 67, EN 593, JIS B 2032
Face to face dimensions	API 609 Category A, MSS-SP 67 W-1 : Size 2 ^B to 14 ^B W-2 : Size 16 ^B to 24 ^B EN 558 basic series 20, ISO 5752 20 Series, JIS B 2002 46 Series

Coupling Flanges

Wafer type	ASME Class 125/150 EN 1092 PN 10: DN 50 to DN 350, PN 16: All Sizes BS 10 Table D/ Table E JIS 10K/16K
Lugged type	ASME Class 125/150 EN 1092 PN 10: DN 50 to DN 150, PN 16: All Sizes

Explanation of Product Code

G - PN16 DJ L U E

1 2 3 4 5 6

1 Valve operation

None Lever handle
G Gear
VG Vertical gear
B Type B pneumatic actuator
BS Type BS pneumatic actuator
FA Type FA pneumatic actuator
FAS Type FAS pneumatic actuator
EXS110/200 ... Type EXS KELMO® electric actuator
EXD110/200 ... Type EXC KELMO® electric proportional control actuator

2 Class

150..... ASME 150 psi
200..... ASME 200 psi
PN16..... EN1092 PN 16
10..... JIS 10K
16..... JIS 16K

3 Valve material and design

DJ..... Ductile iron DJ series
 *Cast iron for JIS10K, Size 350 to 600
FDDJ..... Ductile iron for JIS10K,
 Size 350 to 600 (Option)

4 Connection

None..... Wafer
L..... Lugged
F..... Double flanged

5 Disc material

None..... Ductile iron (Ni-plated)
U..... 304 stainless steel
M..... 316 stainless steel
A..... Aluminum bronze

6 Seat material

None..... NBR (Buna-N)
E..... EPDM

KITZ EJ Series Butterfly Valves

Materials

Parts	Materials
Body	Ductile iron [EN-GJS-450-10]
Stem	Stainless Steel [AISI 410]
Disc	Stainless Steel [A351 Gr.CF8M]
Seat	W-NBR (White NBR) VMQ (Silicone rubber) FKM (Fluoro rubber)
O-ring	FKM
Bearing	Stainless Steel
Stem bearing	Multi-layered bearing*
Plug	Zinc die-cast
Bottom stem	Stainless Steel [AISI 410]

* Tetrafluoroethylene resin filled overlay, a sintered bronze interlayer and a steel backing.

Flange Table

Standard		BS EN 1092			BS10	ASME B16.5
Size		PN6	PN10	PN16	Table E	Class150
inch	mm					
2	50	●	●	●	●	▲
2 1/2	65	▲	●	●	●	▲
3	80	●	●	●	●	●
4	100	●	●	●	●	●
5	125	●	▲	▲	▲	●
6	150	●	●	●	▲	●
8	200	●	●	●	▲	●
10	250	●	▲	●	▲	▲
12	300	●	▲	▲	▲	▲

● : Standard mounting
▲ : Special mounting (Proper centering is required)

Three types of seat material

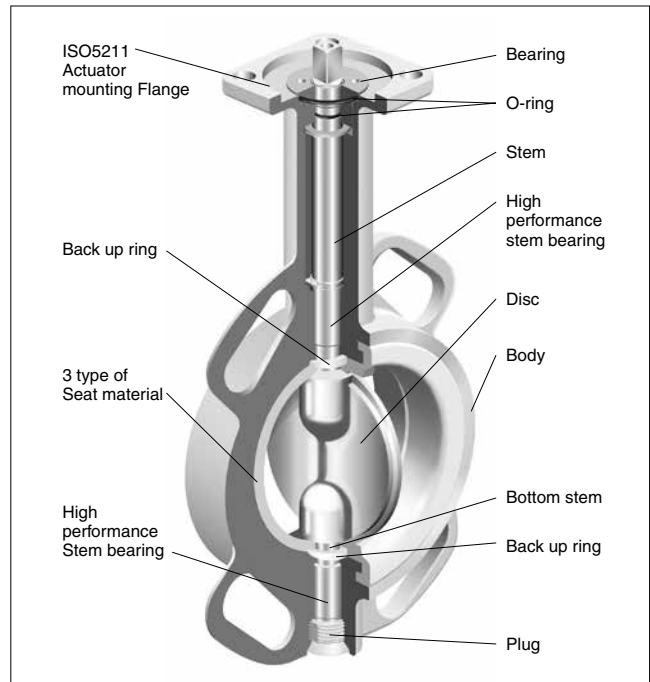
The three types of seat material are as follows: VMQ (Silicone rubber), which can be used for a wide range of temperature applications; W-NBR (White NBR), which is suitable for use in the food processing industry; and FKM (Fluoro rubber), which has properties such as strength and durability for use in a variety of fluid applications. W-NBR and VMQ meet the requirement of the FDA.*

*All the above-listed materials used are approved by the FDA, and the seats are manufactured within the maximum allowable limitations and restrictions.

Suitable for various flanges

All the sizes are suitable for the flanges of EN1092 PN6, PN10, PN16 / BS10 Table E / ASME Class125 and Class150

Design Features



Integral ISO 5211 actuator mounting flange

Any pneumatic or electric valve actuator provided with the ISO 5211 valve mounting flange can be easily mounted for the actuation of valves in the field.

High-performance stem bearing having additional strength to withstand high temperature and high pressure

The stem bearing of the EJ series is a multilayered backmetal to provide a high-performance bearing surface capable of withstanding high pressure and temperature.

Backup ring to maintain the stem sealing

The backup ring around the stem maintains the performance of the stem sealing by the movement of the stem/disc in the sealing/seat of the valve.

Stainless steel bearing features

Embedded within the stainless upper body bearing is a multilayered bearing for providing smooth stem operation. Also housed within the stem bearing is a snap ring to provide protection and prevent blow out of the stem due to internal pressure.

Polished disc

The polished disc is standard for VMQ and optional for W-NBR seats for use within the food and pharmaceutical industry.

Technical Specifications

Maximum service pressure

PN10 10 bar (1.0 MPa)

Body material

Ductile iron EN-GJS-450-10, Equivalent to ASTM A536 Gr. 65-45-12, BS 2789 Gr. 40/10*1

*1 Obsolete Standard.

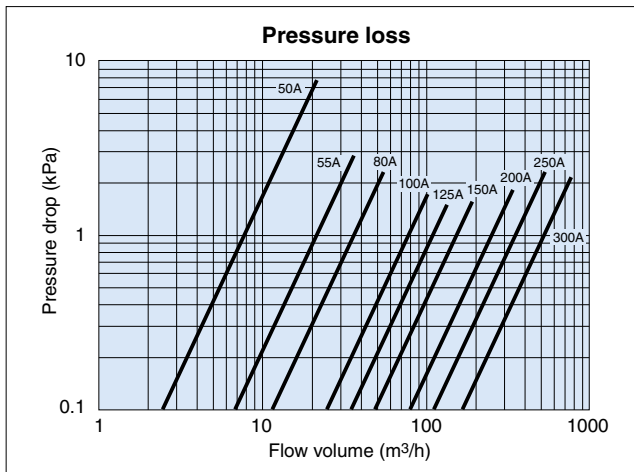
Applicable standards

Valve design EN 593:2004

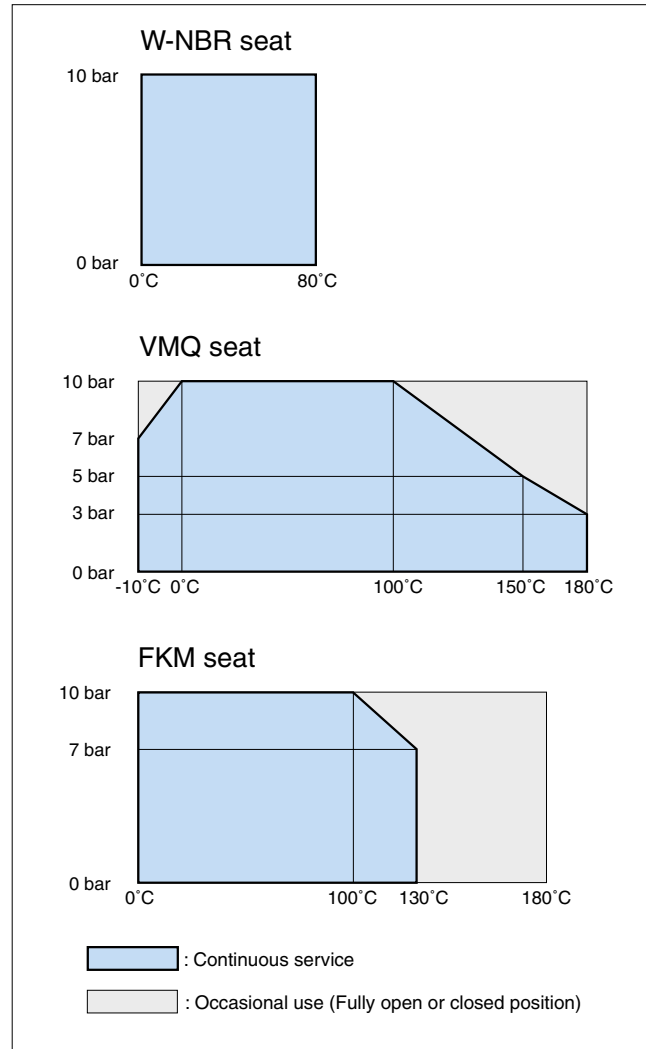
Coupling flanges

Wafer type EN1092 PN6, PN10, PN16
BS10 Table E
ASME Class125, Class150

Technical Data



P-T rating



Explanation of Product Code

G – PN10 EJ M W

1

2

3

4

5

1 Valve operation

None..... Lever handle
G..... Gear

2 Class

PN10

3 Valve material and design

EJ..... Ductile iron EJ series

4 Disc material

M..... 316 stainless steel

5 Seat material

W..... W-NBR
Q..... VMQ
F..... FKM

Please consult KITZ sales staff or our local agent for details of the seat and the disc combination.
Please consult KITZ sales staff or our local agent for vacuum service.

Butterfly Valve

Aluminum Butterfly Valves XJ Series

KITZ XJ Series aluminum butterfly valves: Featured with a unique style of neck designs (U.S.P. No. 6676109) for accommodation of various piping designs, piping positions, and installation environments.

Two neck designs for your choice:

A long neck type and a short neck type are available for versatile applications.

Easy valve-to-flange centering:

The light weight of the die-cast aluminum valve body (which is only one-third of KITZ's conventional cast iron butterfly valves) eases the valve-to-flange centering work on mounting valves on pipelines.

Wide range of service applications:

Austenitic stainless steel discs and EPDM rubber seats can handle many different kinds of line fluids without any concern of corrosion.

Stabilized operating torque:

A pair of stem bearings assembled around the top and bottom stems prevents stem galling and stabilizes the valve operating torque for smooth and trouble-free disc rotation.

On-the-spot actuator assembly:

Actuator mounting pads are designed in conformity with the ISO 5211 requirements for direct on-site mounting of actuators that are provided with ISO 5211 valve mounting flanges.

Prevention of dew condensation (Long neck type):

A long stainless steel neck blocks transfer of the fluid heat to a valve operating device, and thus, no insulation is required. Dew condensation is also minimized in the case of gear-operated valves under cold water service.

Rust prevention:

Key parts such as stems, discs, necks, neck connectors, and endplates, and minor parts such as stopper plates, washers, and boltings are all made of stainless steel for corrosion resistance.

S-shaped spherical disc for high sealing performance (patented):

KITZ's original cross-sectionally S-shaped valve discs with spherical surfaces make tight contact evenly with rubber liners for excellent sealing performance with reduced operating torque. A thorough 360° shut-off mechanism helps extend the service life of the rubber liners. (Size 2 inches and larger.)

Long Neck Type Prevented dew condensation



- A long stainless steel neck reduces conductivity of the fluid heat for prevention of dew condensation.
- Availability of valve body and neck insulation.
- Choice of actuators for automated valve operation.

Applications:

- Building utilities .
- Piping networks for cold water, hot water and other water supply.

Short Neck Type Compact design



- Suitable for piping in a limited space.
- Choice of actuators for automated valve operation.

Applications:

- Building utilities.
- Plant facilities.
- Water treatment service.
- Operation of industrial machineries.



Elaborately designed KITZ EPDM seats are featured with the following uniqueness for functional stability, high sealing performance and long life cycle:

- Self-reinforcing back-ribs
- Wider disc seating contact
- Dual stem seal bearings

- ① Wider disc seating contact for high sealing performance.
- ② Reinforcing back-ribs to minimize valve operating problems such as distortion, skidding and exfoliation of rubber liners caused by line pressure load and friction with metal discs.
- ③ Stem seal bearings are assembled on top and bottom stems for stabilized sealing function.
- ④ Gasketless flange sealing contact for easy valve mounting.

Technical Specification

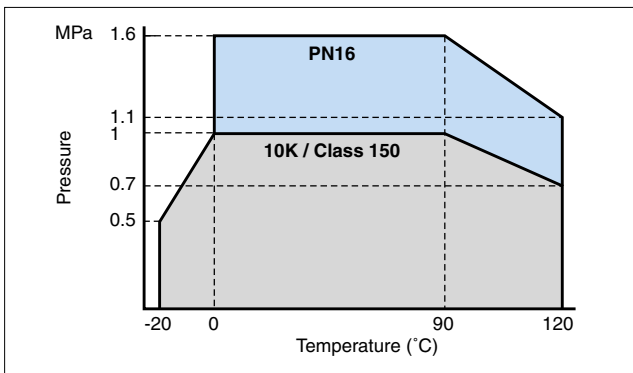
Class	JIS 10K	Class 150	PN16
Maximum service pressure	1 MPa	1 MPa	1.6 MPa (16 bar)
Service temperature range*1	-20°C to +120°C		
Continuous service temperature range*1	0°C to +100°C		
Face to face dimension	API609, BS5155 (Short pattern) ISO 5752-20, JIS B 2002 46 series		
Coupling flanges	JIS B 2220 / 2239 10K	ASME Class 150 ^{*3} JIS B 2220 / 2239 10K	EN1092 PN16*1

*1 Condition : Fluid is not frozen.

*2 Refer to P-T rating chart.

*3 With centering sleeves.
Please refer to our website (www.kitz.co.jp) or contact KITZ for details.

P-T Rating

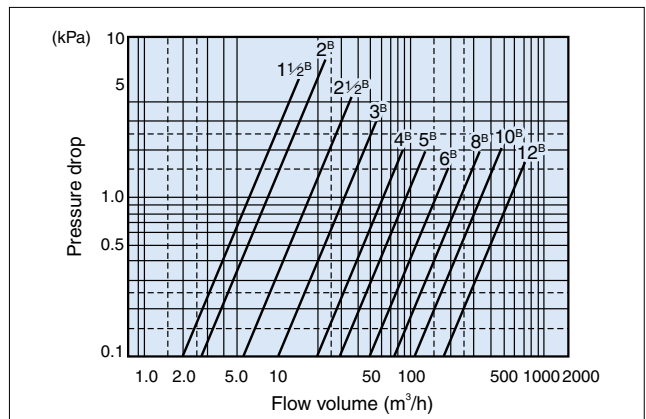


Note : Contact KITZ corporation for technical advice when service conditions may exceed the P-T rating range limited here.

Material

Parts	Material
Body	Aluminum Die-cast / Equivalent ASTM B85-84-383.0
Neck	A351 Gr. CF8
Stem	(Equivalent ASTM A276 Type 410)
Disc	A351 Gr. CF8M
O-ring	EPDM
Rubber seat	EPDM
Bottom stem	(Equivalent ASTM A276 Type 410)
Bearing	Metal Backed PTFE (Size 10 ^B and 12 ^B) Polyphenylenesulfide (10XJMEA : Size 1 ^{1/2} ^B to 8 ^B) Bronze : CAC401C (PN16XJME : Size 2 ^B to 8 ^B)

Pressure Loss (for handling static clean water)



Dew Condensation Test

Samples of KITZ XJ Series butterfly valves equipped with long necks (KITZ Product Code: G-10XJMEA) were tested at KITZ laboratory under the conditions introduced below. Lower surface temperature of gear boxes, atmospheric temperatures and atmospheric humidities were measured as the variable functions. The dew condensations boundary was estimated as illustrated below.

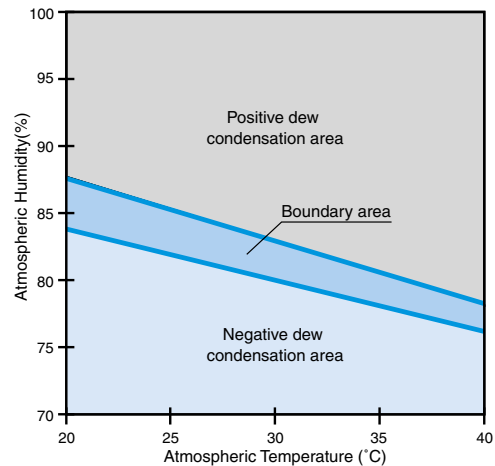
Test condition :

Line fluid : +5°C cold water
Atmospheric temperature : +20°C to +40°C
Valve insulation : 50 mm glass wool (JIS A 9501) around the test valve with gear boxes exposed to the open air.

Note:

The estimation introduced here is a result of summary of the tests carried out within a test basin provided with constant temperature and humidity, and does not necessarily represent absolute values. Note that dew condensation preventative property of these valves may be affected by change of test environments such as extent of air transfer and variation of line fluid temperature, atmospheric humidity or condition of insulation. Thus, acceptance of allowance of ±5% over the boundary area is recommended.

G-10XJMEA Estimated Dew Condensation Boundary



Product Coding

1 Valve operation

None... Lever
G..... Gear
FA..... Pneumatic actuator (Double action)
FAS..... Pneumatic actuator (Spring return action)
EXS..... Electric actuator (Please consult KITZ for availability of power supply)

G - 10 XJ S M E A

2 Class

10..... JIS 10K
10A..... JIS 10K/ASME Class 150
PN16..... EN1092 4504 PN16

3 KITZ Butterfly valve series

XJ.....XJ series

4 Design

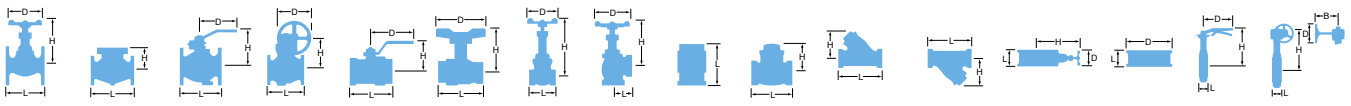
None... Long neck
S..... Short neck

5 Disc material

M.....316 stainless steel

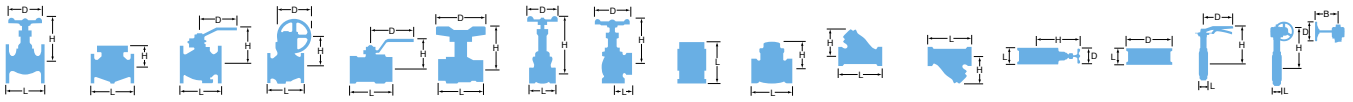
6 Seat material

E.....EPDM



TYPE	BUTTERFLY					BUTTERFLY			BUTTERFLY			BUTTERFLY			BUTTERFLY		
Butterfly Valve																	
FIG	10XJME					G-10XJME			PN16XJME<Z0P01>			G-PN16XJME<Z0P01>			10DJ		
PRESSURE	10K					10K			PN16			PN16			10K		
END CONNECTION	Wafer Type (JIS 5K,10K)					Wafer Type (JIS 5K,10K)			Wafer Type (BS EN 1092 PN16)			Wafer Type (BS EN 1092 PN16)			Wafer Type (JIS 5K,10K)		
DIMENSIONS	inch	mm	L	H	D	L	H	B	L	H	D	L	H	B	L	H	D
	1½	40	33	172	180	33	175	122	—	—	—	—	—	—	—	—	—
	2	50	43	176	180	43	179	122	43	176	180	43	179	122	43	191	180
	2½	65	46	185	180	46	188	122	46	185	180	46	188	122	46	199	180
	3	80	46	193	180	46	196	122	46	193	180	46	196	122	46	217	180
	4	100	52	204	180	52	223	135	52	204	180	52	223	135	52	227	180
	5	125	56	249	230	56	258	150	56	249	230	56	258	150	56	265	230
	6	150	56	261	230	56	270	150	56	261	230	56	270	150	56	277	230
	8	200	—	—	—	60	311	180	—	—	—	60	311	180	—	—	—
	10	250	—	—	—	68	405	180	—	—	—	—	—	—	—	—	—
	12	300	—	—	—	78	430	180	—	—	—	—	—	—	—	—	—
	BODY	Aluminum Die-Cast					Aluminum Die-Cast			Aluminum Die-Cast			Aluminum Die-Cast			Ductile Iron	
STEM	Stainless Steel					Stainless Steel			Stainless Steel			Stainless Steel			Stainless Steel		
DISC	Stainless Steel					Stainless Steel			Stainless Steel			Stainless Steel			Ductile Iron+ENP		
SEAT	EPDM					EPDM			EPDM			EPDM			NBR		
															Ductile iron (Ni-plated) disc		

TYPE	BUTTERFLY					BUTTERFLY			BUTTERFLY			BUTTERFLY			BUTTERFLY		
Butterfly Valve																	
FIG	G-10DJ					G-10DJUE			G-16DJUE			VG-10DJ			PN16DJ		
PRESSURE	10K					10K			16K			10K			PN16		
END CONNECTION	Wafer Type (JIS 5K,10K)					Wafer Type (JIS 10K)			Wafer Type (JIS 16K)			Wafer Type (JIS 5K,10K)			Wafer Type (BS EN 1092 PN16)		
DIMENSIONS	inch	mm	L	H	B	L	H	D	L	H	D	L	H	D	L	H	D
	1½	40	—	—	—	33	175	80	—	—	—	—	—	—	—	—	—
	2	50	43	194	122	43	194	80	43	194	80	43	270	110	43	191	180
	2½	65	46	202	122	46	202	80	46	202	80	46	278	110	46	199	180
	3	80	46	236	135	46	236	110	46	236	110	46	285	110	46	217	180
	4	100	52	246	135	52	246	110	52	246	110	52	295	110	52	227	180
	5	125	56	274	150	56	274	110	56	274	110	56	325	170	56	265	230
	6	150	56	286	150	56	286	110	56	286	110	56	337	170	56	277	230
	8	200	60	325	180	60	325	170	60	325	170	60	404	200	60	295	350
	10	250	68	381	250	68	381	250	68	381	250	68	461	310	—	—	—
	12	300	78	406	250	78	406	250	78	406	250	78	486	310	—	—	—
	14	350	78	445	220	78	445	310	78	461	360	78	569	360	—	—	—
	16	400	102	500	220	102	500	310	102	516	360	102	624	360	—	—	—
	18	450	114	524	220	114	524	310	114	540	360	114	648	360	—	—	—
	20	500	127	589	350	127	589	360	127	623	500	127	741	500	—	—	—
	22	550	—	—	—	154	612	360	—	—	—	—	—	—	—	—	—
	24	600	154	637	350	154	637	360	154	671	500	154	789	500	—	—	—
	26	650	—	—	—	165	710	600	—	—	—	—	—	—	—	—	—
	28	700	—	—	—	165	735	600	—	—	—	—	—	—	—	—	—
	30	750	—	—	—	190	836	500	—	—	—	—	—	—	—	—	—
32	800	—	—	—	190	862	500	—	—	—	—	—	—	—	—	—	
BODY	Ductile Iron/Cast Iron					Ductile Iron/Cast Iron			Ductile Iron			Ductile Iron/Cast Iron			Ductile Iron		
STEM	Stainless Steel					Stainless Steel			Stainless Steel			Stainless Steel			Stainless Steel		
DISC	Ductile Iron+ENP					Stainless Steel			Stainless Steel			Ductile Iron+ENP			Ductile Iron+ENP		
SEAT	NBR					EPDM			EPDM			NBR			NBR		
	Ductile iron (Ni-plated) disc											Ductile iron (Ni-plated) disc			Ductile iron (Ni-plated) disc		



TYPE	BUTTERFLY						BUTTERFLY			BUTTERFLY			BUTTERFLY			BUTTERFLY		
Butterfly Valve																		
FIG	G-PN16DJ						PN16DJL			G-PN16DJL			PN25DJE			PN25DJLE		
PRESSURE	PN16						PN16			PN16			PN25			PN25		
END CONNECTION	Wafer Type (BS EN 1092 PN16)						Lug Type (BS EN 1092 PN16)			Lug Type (BS EN 1092 PN16)			Wafer Type (BS EN 1092 PN25)			Lug Type (BS EN 1092 PN16)		
DIMENSIONS	inch	mm	L	H	B	L	H	D	L	H	B	L	H	D	L	H	D	
	2	50	43	194	122	43	191	180	43	194	122	43	191	180	43	191	180	
	2 1/2	65	46	202	122	46	199	180	46	202	122	46	199	180	46	199	180	
	3	80	46	236	135	46	217	180	46	236	135	46	217	180	46	217	180	
	4	100	52	246	135	52	227	180	52	246	135	52	227	180	52	227	180	
	5	125	56	274	150	56	265	230	56	274	150	56	265	230	56	265	230	
	6	150	56	286	150	56	277	230	56	286	150	56	277	230	56	277	230	
	8	200	60	325	180	60	295	350	60	325	180	-	-	-	-	-	-	
	10	250	68	381	250	-	-	-	68	381	250	-	-	-	-	-	-	
	12	300	78	406	250	-	-	-	78	406	250	-	-	-	-	-	-	
	14	350	78	461	350	-	-	-	78	461	350	-	-	-	-	-	-	
	16	400	102	516	350	-	-	-	102	516	350	-	-	-	-	-	-	
	18	450	114	540	350	-	-	-	114	540	350	-	-	-	-	-	-	
	20	500	127	623	400	-	-	-	127	623	400	-	-	-	-	-	-	
	24	600	154	671	400	-	-	-	154	671	400	-	-	-	-	-	-	
BODY	Ductile Iron						Ductile Iron			Ductile Iron			Ductile Iron			Ductile Iron		
STEM	Stainless Steel						Stainless Steel			Stainless Steel			Stainless Steel			Stainless Steel		
DISC	Ductile Iron+ENP						Ductile Iron+ENP			Ductile Iron+ENP			Ductile Iron+ENP			Ductile Iron+ENP		
SEAT	NBR						NBR			NBR			EPDM			EPDM		
	Ductile iron (Ni-plated) disc						Ductile iron (Ni-plated) disc			Ductile iron (Ni-plated) disc			Ductile iron (Ni-plated) disc			Ductile iron (Ni-plated) disc		

TYPE	BUTTERFLY						BUTTERFLY			BUTTERFLY			BUTTERFLY			BUTTERFLY		
Butterfly Valve																		
FIG	G-150DJ						G-150DJE			G-150DJL			200DJ			200DJL		
PRESSURE	Class 150						Class 150			Class 150			Class 200			Class 200		
END CONNECTION	Wafer Type (ASME B16.5 CL150)						Wafer Type (ASME B16.5 CL150)			Lug Type (ASME B16.5 CL150)			Wafer Type (ASME B16.5 CL150)			Lug Type (ASME B16.5 CL150)		
DIMENSIONS	inch	mm	L	H	B	L	H	B	L	H	B	L	H	D	L	H	D	
	2	50	-	-	-	-	-	-	-	-	-	42.9	191	180	42.9	191	180	
	2 1/2	65	-	-	-	-	-	-	-	-	-	46	199	180	46	199	180	
	3	80	-	-	-	-	-	-	-	-	-	46	217	180	46	217	180	
	4	100	-	-	-	-	-	-	-	-	-	52.3	227	180	52.3	227	180	
	5	125	-	-	-	-	-	-	-	-	-	55.6	265	230	55.6	265	230	
	6	150	-	-	-	-	-	-	-	-	-	55.6	277	230	55.6	277	230	
	8	200	-	-	-	-	-	-	-	-	-	60.5	295	350	60.5	295	350	
	10	250	-	-	-	-	-	-	-	-	-	-	-	-	-	-	-	
	12	300	-	-	-	-	-	-	-	-	-	-	-	-	-	-	-	
	14	350	77.7	447	220	77.7	447	220	77.7	447	220	-	-	-	-	-	-	
	16	400	101.6	502	220	101.6	502	220	101.6	502	220	-	-	-	-	-	-	
	18	450	114.3	526	220	114.3	526	220	114.3	526	220	-	-	-	-	-	-	
	20	500	127	587	360	127	587	360	127	587	360	-	-	-	-	-	-	
	24	600	153.9	635	360	153.9	635	360	153.9	635	360	-	-	-	-	-	-	
BODY	Ductile Iron						Ductile Iron			Ductile Iron			Ductile Iron			Ductile Iron		
STEM	Stainless Steel						Stainless Steel			Stainless Steel			Stainless Steel			Stainless Steel		
DISC	Ductile Iron+ENP						Ductile Iron+ENP			Ductile Iron+ENP			Ductile Iron+ENP			Ductile Iron+ENP		
SEAT	NBR						EPDM			NBR			NBR			NBR		
	Ductile iron (Ni-plated) disc						Ductile iron (Ni-plated) disc			Ductile iron (Ni-plated) disc			Ductile iron (Ni-plated) disc			Ductile iron (Ni-plated) disc		

Brass & Bronze

Cast Iron

Ductile Iron

Stainless Steel

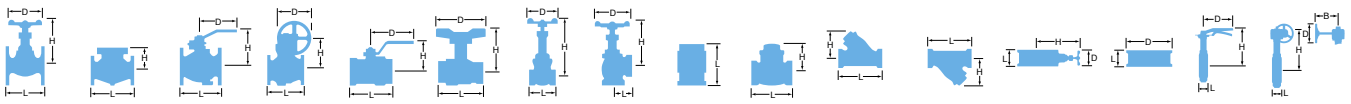
Carbon Steel

Butterfly Valve

Ball Valve

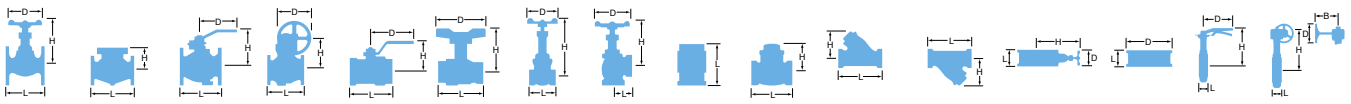
Ball Valve Seal

Actuated Valve



TYPE		BUTTERFLY			BUTTERFLY			BUTTERFLY			BUTTERFLY			BUTTERFLY			
Butterfly Valve																	
FIG		G-200DJ			G-200DJE			G-200DJL			G-200DJLE			250DJ			
PRESSURE		Class 200			Class 200			Class 200			Class 200			Class 250			
END CONNECTION		Wafer Type (ASME B16.5 CL150)			Wafer Type (ASME B16.5 CL150)			Lug Type (ASME B16.5 CL150)			Lug Type (ASME B16.5 CL150)			Wafer Type (ASME B16.5 CL150)			
DIMENSIONS	inch	mm	L	H	B	L	H	B	L	H	B	L	H	B	L	H	D
	2	50	42.9	194	121.5	42.9	194	121.5	42.9	194	121.5	42.9	194	121.5	42.9	191	180
	2½	65	46	202	121.5	46	202	121.5	46	202	121.5	46	202	121.5	46	199	180
	3	80	46	236	135	46	236	135	46	236	135	46	236	135	46	217	180
	4	100	52.3	246	135	52.3	246	135	52.3	246	135	52.3	246	135	52.3	227	180
	5	125	55.6	274	150	55.6	274	150	55.6	274	150	55.6	274	150	55.6	265	230
	6	150	55.6	286	150	55.6	286	150	55.6	286	150	55.6	286	150	55.6	277	230
	8	200	60.5	325	180	60.5	325	180	60.5	325	180	60.5	325	180	60.5	295	350
	10	250	68.3	381	180	68.3	381	180	68.3	381	180	68.3	381	180	—	—	—
	12	300	77.7	406	180	77.7	406	180	77.7	406	180	77.7	406	180	—	—	—
BODY		Ductile Iron			Ductile Iron			Ductile Iron			Ductile Iron			Ductile Iron			
STEM		Stainless Steel			Stainless Steel			Stainless Steel			Stainless Steel			Stainless Steel			
DISC		Ductile Iron+ENP			Ductile Iron+ENP			Ductile Iron+ENP			Ductile Iron+ENP			Ductile Iron+ENP			
SEAT		NBR			EPDM			NBR			EPDM			NBR			
		Ductile iron (Ni-plated) disc			Ductile iron (Ni-plated) disc			Ductile iron (Ni-plated) disc			Ductile iron (Ni-plated) disc			Ductile iron (Ni-plated) disc			

TYPE		BUTTERFLY			BUTTERFLY			BUTTERFLY			BUTTERFLY			BUTTERFLY			
Butterfly Valve																	
FIG		G-250DJ			G-250DJE			250DJL			G-250DJL			G-250DJLE			
PRESSURE		Class 250			Class 250			Class 250			Class 250			Class 250			
END CONNECTION		Wafer Type (ASME B16.5 CL150)			Wafer Type (ASME B16.5 CL150)			Lug Type (ASME B16.5 CL150)			Lug Type (ASME B16.5 CL150)			Lug Type (ASME B16.5 CL150)			
DIMENSIONS	inch	mm	L	H	B	L	H	B	L	H	D	L	H	B	L	H	B
	2½	65	46	202	121.5	46	202	121.5	46	199	180	46	202	121.5	46	202	121.5
	3	80	46	236	135	46	236	135	46	217	180	46	236	135	46	236	135
	4	100	52.3	246	135	52.3	246	135	52.3	227	180	52.3	246	135	52.3	246	135
	5	125	55.6	274	150	55.6	274	150	55.6	265	230	55.6	274	150	55.6	274	150
	6	150	55.6	286	150	55.6	286	150	55.6	277	230	55.6	286	150	55.6	286	150
	8	200	60.5	325	180	60.5	325	180	60.5	295	350	60.5	325	180	60.5	325	180
	10	250	68.3	381	250	68.3	381	250	—	—	—	68.3	381	250	68.3	381	250
	12	300	77.7	406	250	77.7	406	250	—	—	—	77.7	406	250	77.7	406	250
BODY		Ductile Iron			Ductile Iron			Ductile Iron			Ductile Iron			Ductile Iron			
STEM		Stainless Steel			Stainless Steel			Stainless Steel			Stainless Steel			Stainless Steel			
DISC		Ductile Iron+ENP			Ductile Iron+ENP			Ductile Iron+ENP			Ductile Iron+ENP			Ductile Iron+ENP			
SEAT		NBR			EPDM			NBR			NBR			EPDM			
		Ductile iron (Ni-plated) disc			Ductile iron (Ni-plated) disc			Ductile iron (Ni-plated) disc			Ductile iron (Ni-plated) disc			Ductile iron (Ni-plated) disc			



TYPE		BUTTERFLY			BUTTERFLY			BUTTERFLY			BUTTERFLY			BUTTERFLY			
Butterfly Valve																	
FIG		G-250DJA			G-250DJAЕ			G-250DJLA			G-250DJLAE			10SHB			
PRESSURE		Class 250			Class 250			Class 250			Class 250			10K			
END CONNECTION		Wafer Type (ASME B 16.5 CL150)			Wafer Type (ASME B 16.5 CL150)			Lug Type (ASME B16.5 CL150)			Lug Type (ASME B16.5 CL150)			Wafer Type (JIS 10K)			
DIMENSIONS	inch	mm	L	H	B	L	H	B	L	H	B	L	H	B	L	H	D
	2	50	42.9	194	121.5	42.9	194	121.5	42.9	194	121.5	42.9	194	121.5	43	190	230
	2 1/2	65	46	202	121.5	46	202	121.5	46	202	121.5	46	202	121.5	46	203	230
	3	80	46	236	135	46	236	135	46	236	135	46	236	135	46	223	280
	4	100	52.3	246	135	52.3	246	135	52.3	246	135	52.3	246	135	52	237	280
	5	125	55.6	274	150	55.6	274	150	55.6	274	150	55.6	274	150	56	258	350
	6	150	55.6	286	150	55.6	286	150	55.6	286	150	55.6	286	150	56	275	350
	8	200	60.5	325	180	60.5	325	180	60.5	325	180	60.5	325	180	—	—	—
	10	250	68.3	381	250	68.3	381	250	68.3	381	250	68.3	381	250	—	—	—
	12	300	77.7	406	250	77.7	406	250	77.7	406	250	77.7	406	250	—	—	—
BODY		Ductile Iron			Ductile Iron			Ductile Iron			Ductile Iron			Ductile Iron			
STEM		Stainless Steel			Stainless Steel			Stainless Steel			Stainless Steel			Stainless Steel			
DISC		Aluminum-Bronze			Aluminum-Bronze			Aluminum-Bronze			Aluminum-Bronze			Stainless Steel+HCr			
SEAT		NBR			EPDM			NBR			EPDM			C/F PTFE			

TYPE		BUTTERFLY			BUTTERFLY			BUTTERFLY			BUTTERFLY			BUTTERFLY			
Butterfly Valve																	
FIG		16SHB			150SHB			G-10SHB			G-16SHB			G-150SHB			
PRESSURE		16K			Class 150			10K			16K			Class 150			
END CONNECTION		Wafer Type (JIS 16K)			Wafer Type (ASME B16.5 CL150)			Wafer Type (JIS 10K)			Wafer Type (JIS 16K)			Wafer Type (ASME B16.5 CL150)			
DIMENSIONS	inch	mm	L	H	D	L	H	D	L	H	B	L	H	B	L	H	B
	2 1/2	65	43	190	230	43	190	230	43	209	150	43	209	150	43	209	150
	3	80	46	203	230	46	203	230	46	222	150	46	222	150	46	222	150
	4	100	46	223	280	46	223	280	46	240	150	46	240	150	46	240	150
	5	125	52	237	280	52	237	280	52	254	150	52	254	150	52	254	150
	6	150	56	258	350	56	258	350	56	280	180	56	280	180	56	280	180
	8	200	56	275	350	56	275	350	56	297	180	56	297	180	56	297	180
	10	250	—	—	—	—	—	—	60	324	205	60	324	205	60	324	205
	12	300	—	—	—	—	—	—	68	401	220	68	401	220	68	401	220
			—	—	—	—	—	—	78	429	220	78	429	220	78	429	220
BODY		Ductile Iron			Ductile Iron			Ductile Iron			Ductile Iron			Ductile Iron			
STEM		Stainless Steel			Stainless Steel			Stainless Steel			Stainless Steel			Stainless Steel			
DISC		Stainless Steel+HCr			Stainless Steel+HCr			Stainless Steel+HCr			Stainless Steel+HCr			Stainless Steel+HCr			
SEAT		C/F PTFE			C/F PTFE			C/F PTFE			C/F PTFE			C/F PTFE			

Bronze & Brass

Cast Iron

Ductile Iron

Stainless Steel

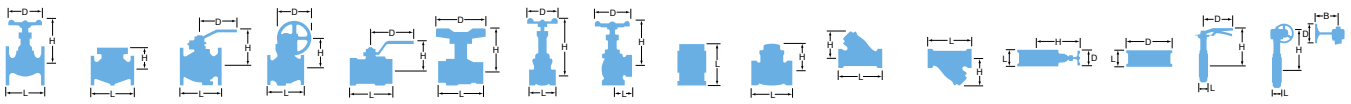
Carbon Steel

Butterfly Valve

Ball Valve

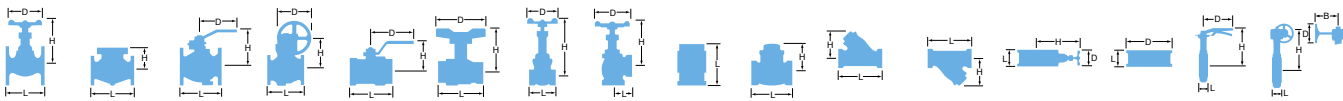
Ball Valve Seal



Actuated Valve



TYPE	BUTTERFLY					BUTTERFLY			BUTTERFLY			BUTTERFLY			BUTTERFLY		
Butterfly Valve																	
FIG	10UB					GL-10UB			GL-150UB			10NFJNE			G-10NFJNE		
PRESSURE	10K					10K			Class 150			10K			10K		
END CONNECTION	Wafer Type (JIS 10K)					Wafer Type (JIS 10K)			Wafer Type (ASME B16.5 CL150)			Wafer Type (JIS 5K,10K)			Wafer Type (JIS 5K,10K)		
DIMENSIONS	inch	mm	L	H	D	L	H	B	L	H	B	L	H	D	L	H	B
	1½	40	33	183	230	33	202	150	33	202	150	—	—	—	—	—	—
	2	50	43	176	230	43	192	150	43	192	150	43	176	180	43	179	122
	2½	65	46	186	230	46	202	150	46	202	150	46	184	180	46	187	122
	3	80	46	207	280	46	226	195	46	226	195	46	194	180	46	213	135
	4	100	52	221	280	52	240	195	52	240	195	52	204	180	52	223	135
	5	125	56	241	350	56	261	204	56	261	204	56	249	230	56	258	150
	6	150	56	263	350	56	283	204	56	283	204	56	261	230	56	270	150
	8	200	—	—	—	71	348	280	71	348	280	—	—	—	60	311	180
	10	250	—	—	—	76	416	310	—	—	—	—	—	—	68	381	250
	12	300	—	—	—	83	443	310	—	—	—	—	—	—	78	406	250
	14	350	—	—	—	92	475	358	—	—	—	—	—	—	—	—	—
	16	400	—	—	—	102	572	360	—	—	—	—	—	—	—	—	—
	18	450	—	—	—	114	607	360	—	—	—	—	—	—	—	—	—
20	500	—	—	—	127	623	360	—	—	—	—	—	—	—	—	—	
24	600	—	—	—	154	757	371	—	—	—	—	—	—	—	—	—	
BODY	Stainless Steel					Stainless Steel			Stainless Steel			Ductile Iron			Ductile Iron		
STEM	Stainless Steel					Stainless Steel			Stainless Steel			Stainless Steel			Stainless Steel		
DISC	Stainless Steel					Stainless Steel			Stainless Steel			Ductile Iron+Nylon11			Ductile Iron+Nylon11		
SEAT	PTFE					PTFE			PTFE			EPDM			EPDM		
												Nylon Coated disc			Nylon Coated disc		

TYPE	BUTTERFLY					BUTTERFLY			DAMPER			DAMPER			DAMPER		
Butterfly Valve																	
FIG	10NFJNW					G-10NFJNW			10D			GL-10D			GL-10A		
PRESSURE	10K					10K			10K			10K			10K		
END CONNECTION	Wafer Type (JIS 5K,10K)					Wafer Type (JIS 5K,10K)			Wafer Type (JIS 5K,10K)			Wafer Type (JIS 5K,10K)			Wafer Type (JIS 5K,10K)		
DIMENSIONS	inch	mm	L	H	D	L	H	B	L	H	D	L	H	B	L	H	B
	2	50	43	176	180	43	179	122	40	183	200	40	198	150	40	198	150
	2½	65	46	184	180	46	187	122	45	191	200	45	206	150	45	206	150
	3	80	46	194	180	46	213	135	50	198	200	50	213	150	50	213	150
	4	100	52	204	180	52	223	135	60	208	200	60	223	150	60	223	150
	5	125	56	249	230	56	258	150	65	237	280	65	249	190	65	249	190
	6	150	56	261	230	56	270	150	70	247	280	70	259	190	70	259	190
	8	200	—	—	—	60	311	180	80	272	280	80	284	190	80	284	190
	10	250	—	—	—	68	381	250	90	340	350	90	355	195	90	355	195
12	300	—	—	—	78	406	250	100	365	350	100	380	195	100	380	195	
BODY	Ductile Iron					Ductile Iron			Cast Iron+HCr			Cast Iron+HCr			Cast Iron+HCr		
STEM	Stainless Steel					Stainless Steel			Stainless Steel			Stainless Steel			Stainless Steel		
DISC	Ductile Iron+Nylon11					Ductile Iron+Nylon11			Stainless Steel			Stainless Steel			Stainless Steel		
SEAT	White-NBR					White-NBR			—			—			—		
	Nylon Coated disc					Nylon Coated disc											



TYPE	BUTTERFLY			BUTTERFLY			BUTTERFLY			BUTTERFLY			BUTTERFLY				
Butterfly Valve																	
FIG	UV			FV			PN10EJMQ			PN10EJMW			PN10EJMF				
PRESSURE	Class 175			Class 175			PN10			PN10			PN10				
END CONNECTION	BS21 (JIS B0203)			BS21 (JIS B0203)			EN 1092 PN16			EN 1092 PN16			EN 1092 PN16				
DIMENSIONS	inch	mm	L	H	D	L	H	D	L	H	D	L	H	D	L	H	D
	1/2	15	43	44	85	47	44	85	-	-	-	-	-	-	-	-	-
	3/4	20	47	47	85	51	47	85	-	-	-	-	-	-	-	-	-
	1	25	56	50	85	58	50	85	-	-	-	-	-	-	-	-	-
	1 1/4	32	63	60	110	67	60	110	-	-	-	-	-	-	-	-	-
	1 1/2	40	69	63	110	73	63	110	-	-	-	-	-	-	-	-	-
	2	50	77	70	110	82	70	110	43	191	180	43	191	180	43	191	180
	2 1/2	65	-	-	-	-	-	-	46	199	180	46	199	180	46	199	180
	3	80	-	-	-	-	-	-	46	217	180	46	217	180	46	217	180
	4	100	-	-	-	-	-	-	52	227	180	52	227	180	52	227	180
	5	125	-	-	-	-	-	-	56	265	230	56	265	230	56	265	230
	6	150	-	-	-	-	-	-	56	277	230	56	277	230	56	277	230
	8	200	-	-	-	-	-	-	60	295	350	60	295	350	60	295	350
	10	250	-	-	-	-	-	-	-	-	-	-	-	-	-	-	-
	12	300	-	-	-	-	-	-	-	-	-	-	-	-	-	-	-
BODY	Stainless Steel			Forged Brass			Ductile Iron			Ductile Iron			Ductile Iron				
STEM	Stainless Steel			Stainless Steel			Stainless Steel			Stainless Steel			Stainless Steel				
DISC	Stainless Steel+W-NBR			Stainless Steel+W-NBR			Stainless Steel			Stainless Steel			Stainless Steel				
SEAT	NBR			NBR			VMQ			W-NBR			FKM				

Bronze & Brass

Cast Iron

Ductile Iron

Stainless Steel

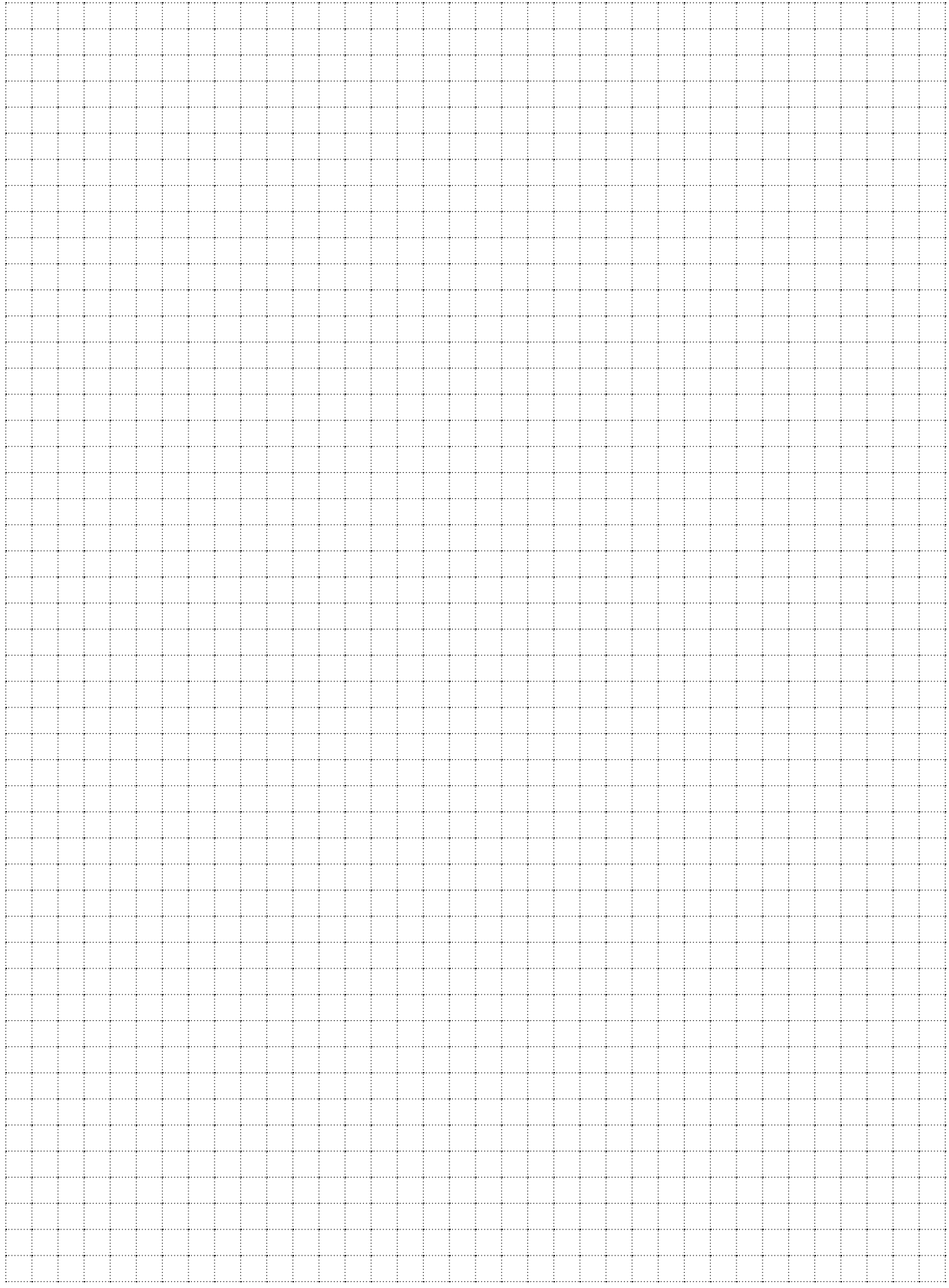
Carbon Steel

Butterfly Valve

Ball Valve

Ball Valve Seal

Actuated Valve



BALL VALVE

Ball Valve

KITZ Steel Ball Valves Floating Ball Design

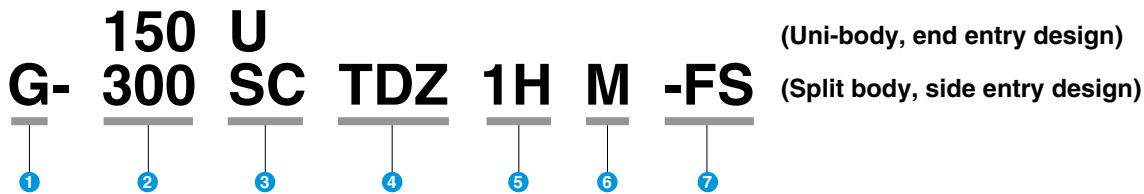
Design and Inspection Standards of KITZ Flanged Ball Valves

Item		American Standards	British Standards
Pressure-temperature ratings	Body	ASME B16.34	BS 5351
	Resilient sealing parts	KITZ Standard	
Shell wall thickness		ASME B16.34	BS 5351
Face to face dimensions		ASME B16.10	BS 2080*1
End flange dimensions and flange gasket facing		ASME B16.5	BS 1560
Pressure test		API 598	BS 6755 Part 1*2
Fire test		API 607 and API 6FA	BS 6755 Part 2

*1 Option for 2nd to 4th Class 150 full port design.

Explanation of Product Coding

Example:



1 Valve operation measure

- None** Lever handle
- G** Worm gear
- B** KITZ Type B double action pneumatic actuator
- BS** KITZ Type BS Spring return pneumatic actuator
- BSW** KITZ Type BSW Spring return pneumatic actuator with manual operation device
- FA** KITZ Type FA double action pneumatic actuator
- FAS** KITZ Type FAS spring return pneumatic actuator
- E** Electric actuator

2 ASME pressure class

150, 300, 600 or 1500

3 & 6 Shell material & Trim material

- U: Symbol of stainless or high alloy steel
- SC: Symbol of carbon or low alloy steel
- U/None** CF8 **U/CN** CN7M
- U/M** CF8M **U/HB** N-12MV
- U/V** CF3 **U/HC** CW-12MW
- U/O** CF3M **SC/None/None*** ... WCB/CF8
- U/CB** CF8C **SC/None/M*** WCB/CF8M
- U/CG** CG8M **SC/CL/None*** LCC/CF8
- U/CK** CK20 **SC/CL/M*** LCC/CF8M
- U/SD** CD3MWCuN

4 Valve design & type

- TDZ** Type TDZ
- TDZX** Extended stem, Type TDZ
- TB** Type TB
- TR** Type TR
- TBP** Pocketless, Type TB
- TB2L** 3-way 2-seat, L-port, Type TB
- TB2T** 3-way 2-seat, T-port, Type TB
- TB4LA** 3-way 4-seat, L-port, Type TB
- TB4TA** 3-way 4-seat, T-port, Type TB
- TBT** Direct routing to tank bottom
- TBJ** Jacketed, Type TB
- TBLN** PFA lined, Type TB
- TAZ** Type TA

5 Seat Material

- None** HYPATITE® PTFE
- 1H**** FILLTITE®
- 3H**** Hard graphite seat for low abrasion service, 500°C
- 5H**** Metal seat for abrasive service, 300°C
- 6H**** Metal seat for high abrasive service, 500°C
- ** Type TDZ only

6 See 3

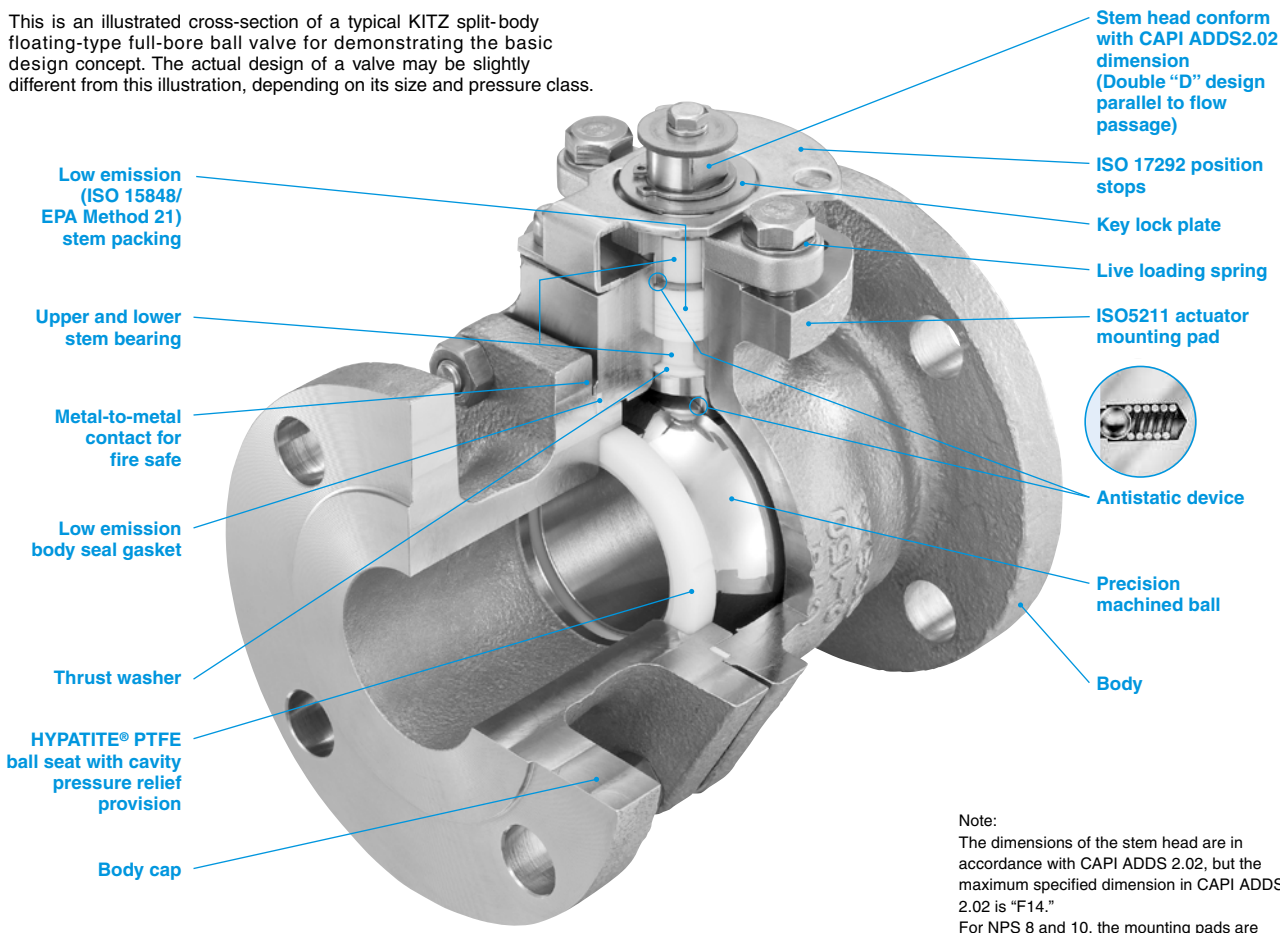
7 No symbol suffixed for PTFE packing and gasket.

"FS" or "S" suffixed for flexible graphite packing and gasket for super-firesafe provision

This catalog uses **MPa**, a SI unit, for indication of pressures. **psi** and **kgf/cm²** are also added for readers convenience.

KITZ 150/300 SCTDZ/UTDZ Series Full-Bore, Split-Body, Side Entry Ball Valves

This is an illustrated cross-section of a typical KITZ split-body floating-type full-bore ball valve for demonstrating the basic design concept. The actual design of a valve may be slightly different from this illustration, depending on its size and pressure class.



KITZ 150UTDZ 2^B

Note:
The dimensions of the stem head are in accordance with CAPI ADDS 2.02, but the maximum specified dimension in CAPI ADDS 2.02 is "F14."
For NPS 8 and 10, the mounting pads are F16/ ISO 5211.

Bubble-tight sealing performance with HYPATITE® PTFE ball seats

HYPATITE® PTFE ball seats, which are the standard stem seals of KITZ ball valves, are made of denatured PTFE—a molecularly reinforced PTFE copolymer—and specifically engineered for ensuring high bidirectional sealing performance and prolonged service life of valves. Its resistance to high or low temperature, creep or compression, abrasion, and corrosion is outstanding. As an option, KITZ **SWELLESS®** ball seats made primarily of PFA are recommended specifically for monomer service. This epoch-making new seat maximizes resistance to the permeation of the monomer into its molecular structure (generally known as a "swelling" problem), which causes seat deformation and gravely affects the shut-off function of valves in styrene and butadiene monomer service.

Simplified actuator mounting

For 150/300 SCTDZ/UTDZ and SCTAZ/UTAZ Series ball valves, the ISO 5211 actuator mounting pad is integrally provided for achieving uniformly simplified mounting of any actuators provided with the valve mounting flanges designed to the ISO 5211 dimensional requirement. The 150UTB Series ball valves are provided with the KITZ standard integral actuator mounting pad.

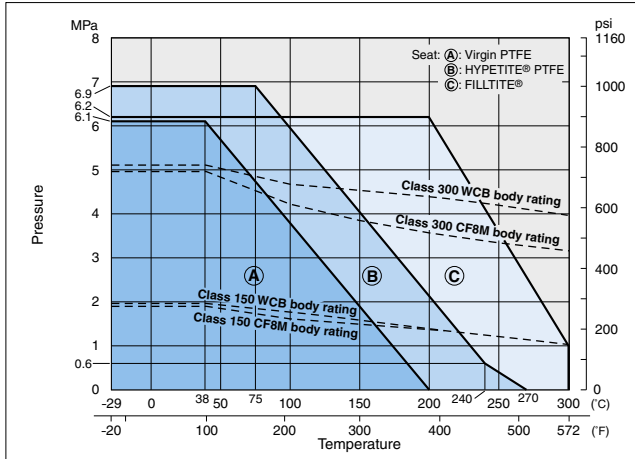
Easy maintenance

The split-body design provided for the KITZ SCTDZ/UTDZ Series provides the convenience of extremely easy maintenance, which is critically required for process plants. Body inserts of a unibody, end-entry design for the KITZ 150/300 SCTDZ/UTDZ Series are threaded into the valve body with provision of unthreading for valve disassembly in the case of maintenance operation.

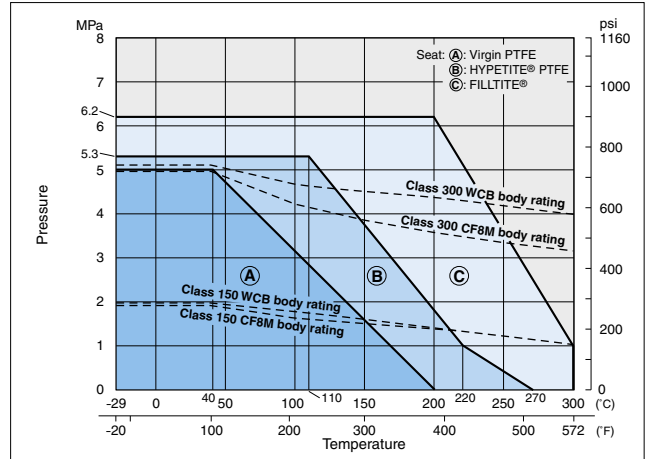
Ball Valve

Pressure-Temperature Ratings

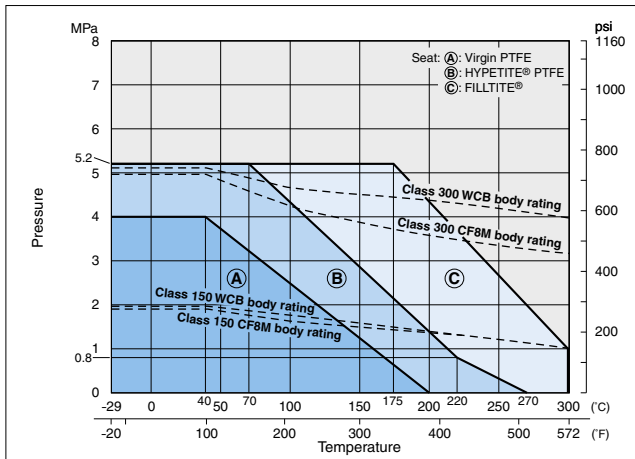
150/300UTDZM/SCTDZ: 1/2^B and 3/4^B



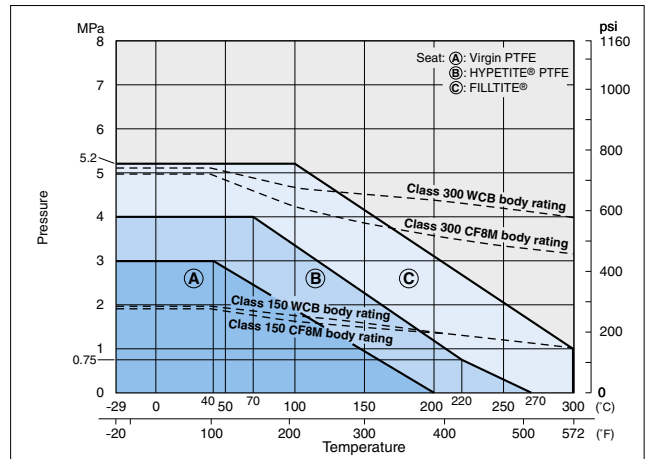
150/300UTDZM/SCTDZ: 1^B to 2 1/2^B



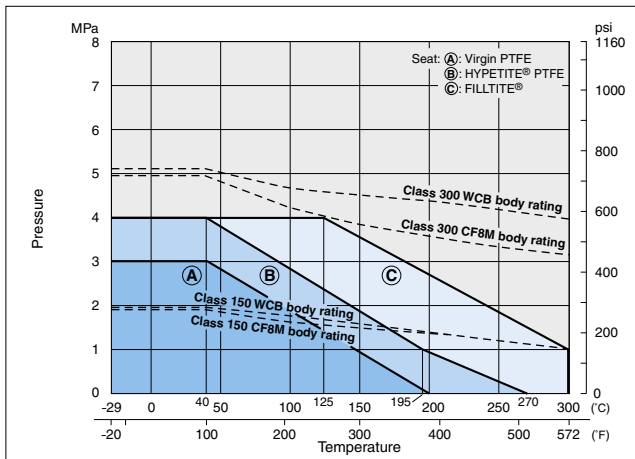
150/300UTDZM/SCTDZ: 3^B and 4^B



150/300UTDZM/SCTDZ: 5^B and 6^B

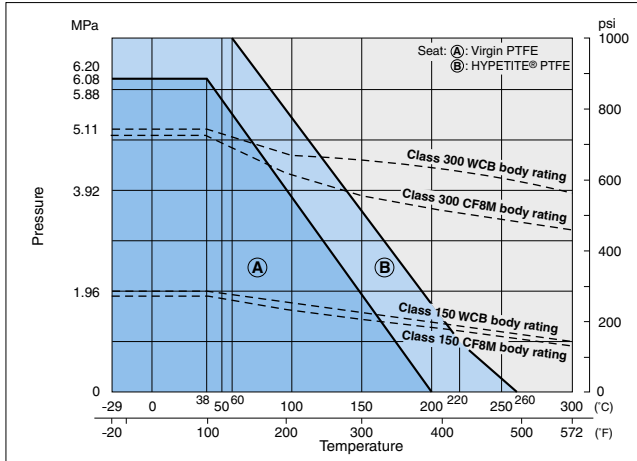


150/300UTDZM/SCTDZ: 8^B and 10^B

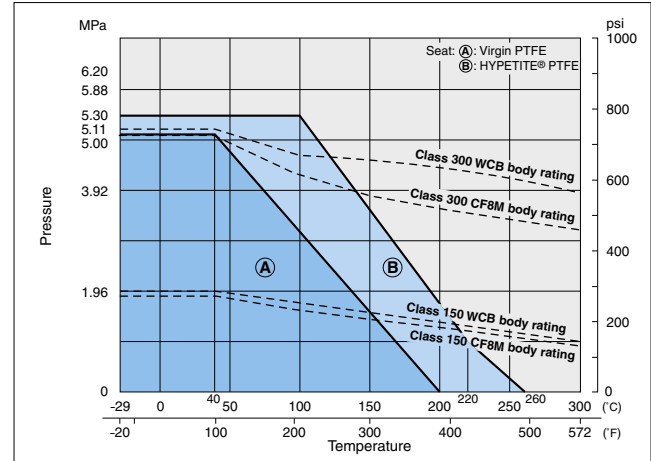


Pressure-Temperature Ratings

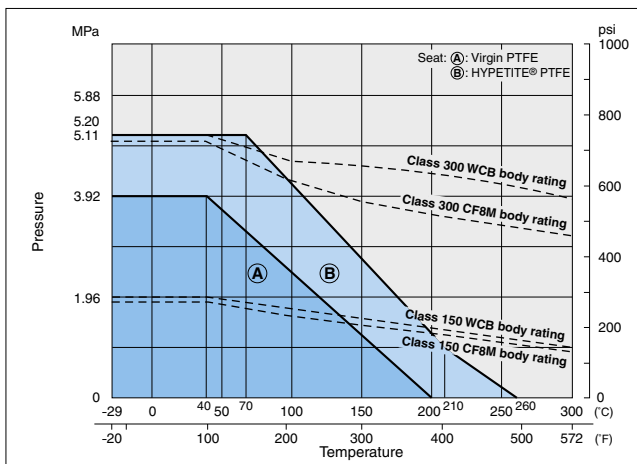
150UTBM : 1/2^B and 3/4^B



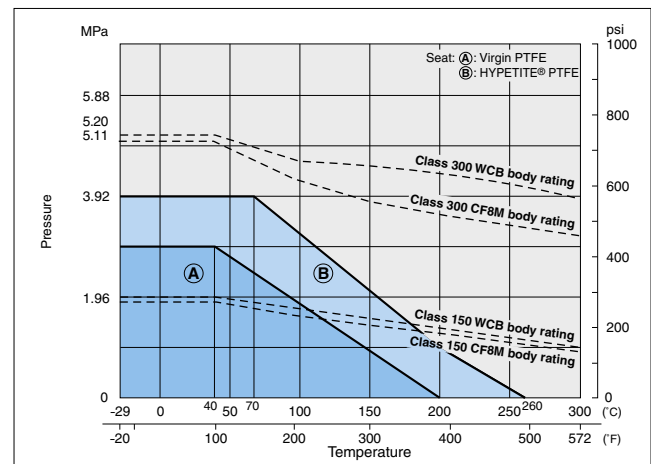
150UTBM : 1^B to 2 1/2^B



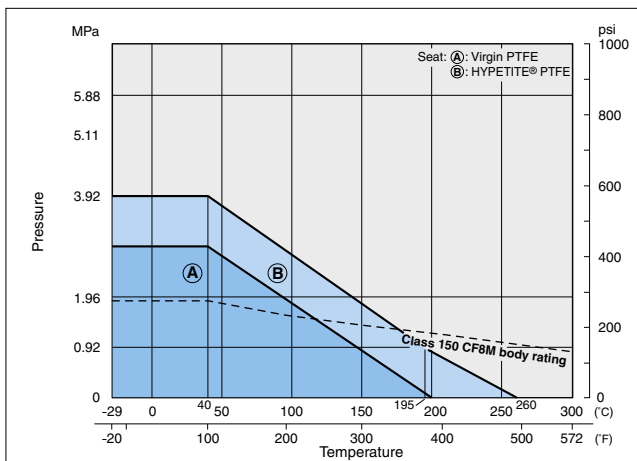
150UTBM : 3^B and 4^B



150UTBM : 5^B and 6^B



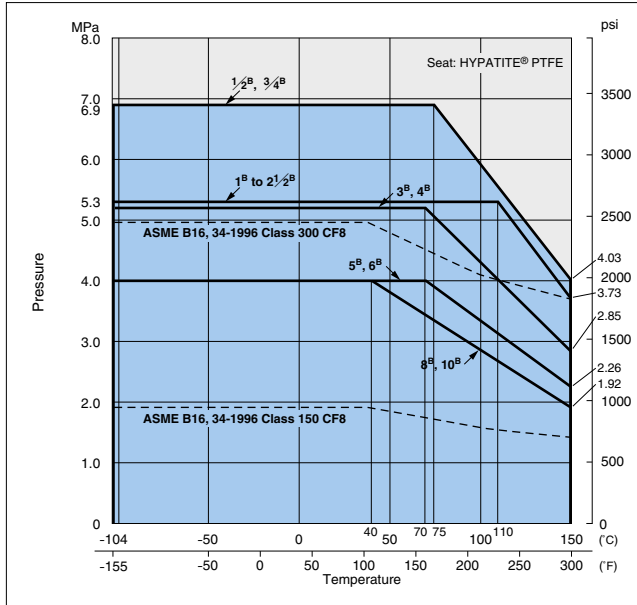
150UTBM : 8^B and 10^B



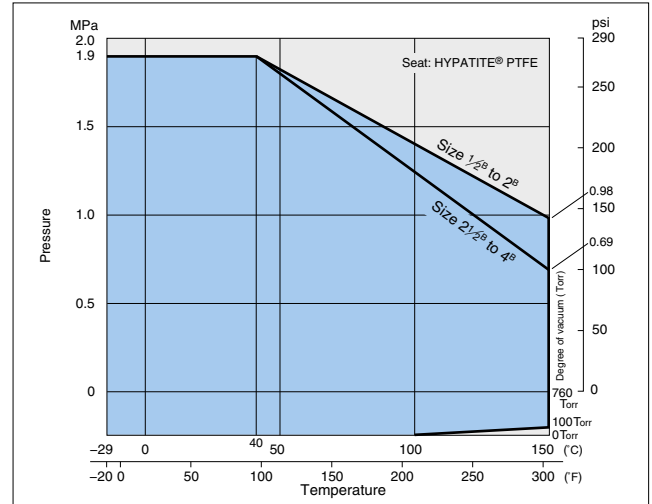
Ball Valve

Pressure-Temperature Ratings

150/300UTDZXL

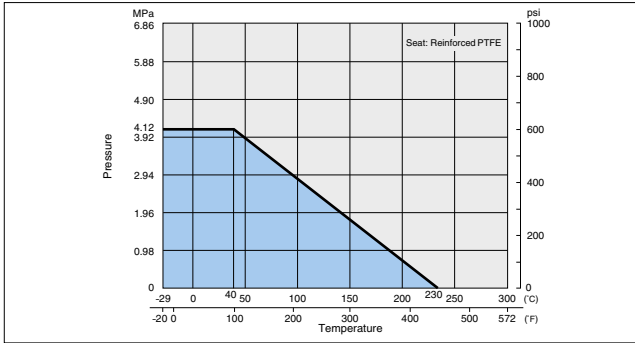


PFA Lined: 10UTBLN

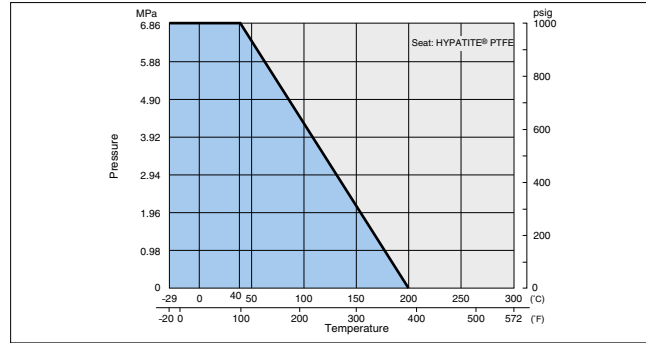


Pressure-Temperature Ratings

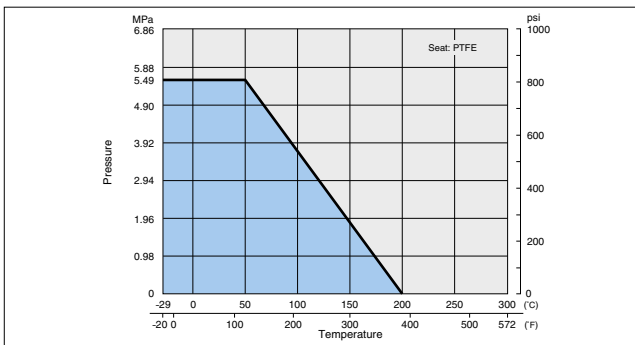
Type 600: **SCTK/UTKM**



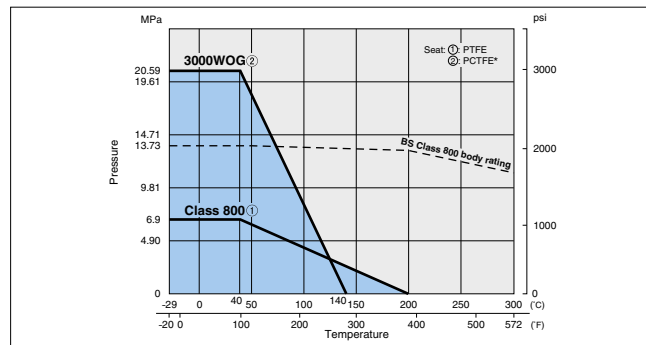
Type 1000: **UTFM/UTHL**



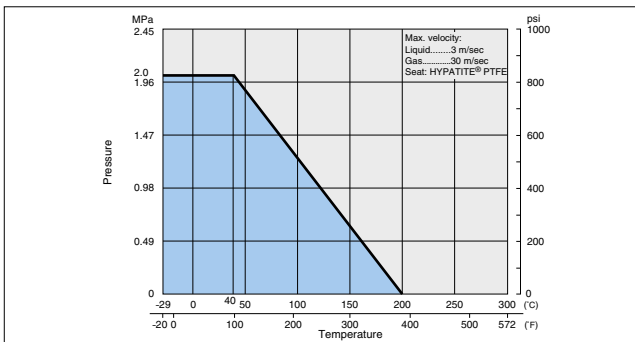
Type 800: **UTHM**



Class 800 and Type 3000: **SCTK**



Type 800: **UTH4LM/4TM**



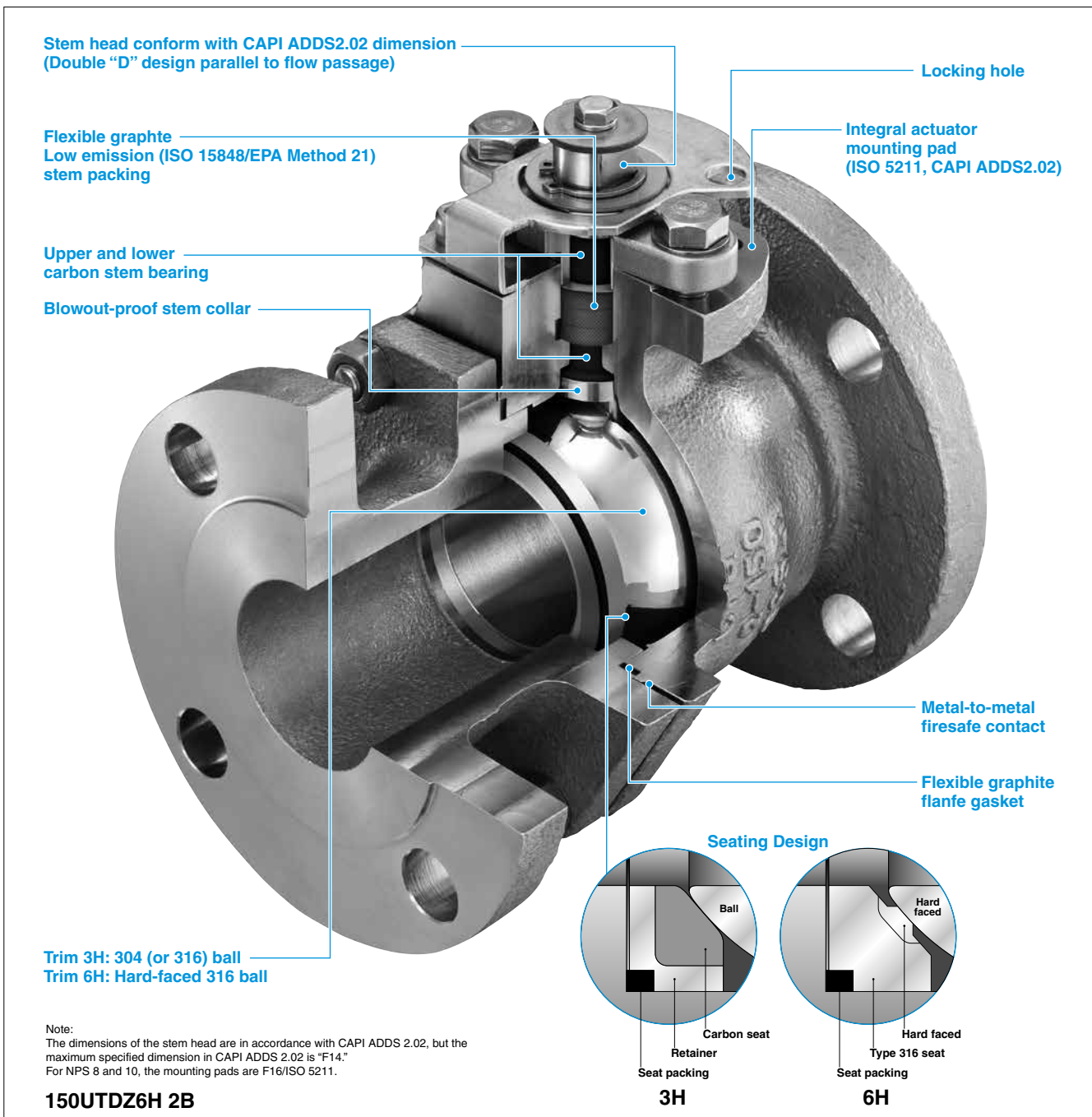
Ball Valve

KITZ Steel Ball Valves for High Temperature

Design Feature Trim 3H, 5H, 6H

Split-Body, Side-Entry, Full-Bore Design

This is an illustrated cross-section of a typical KITZ high performance ball valve for demonstrating the basic design concept. The actual design of a valve may be slightly different from this illustration, depending on its size and pressure class.



Technical Data

1. Choice of trim for heated abrasive service

For metal seated ball valves, a maximum service temperature of 300°C (572°F) (Trim symbol 5H) and 500°C (932°F) (Trim symbol 6H*) is guaranteed. For hard graphite seated ball valves, a maximum service temperature of 500°C (932°F) is also guaranteed (Trim symbol 3H*). Heat-resistant sealing and trim materials qualify these valves for heated abrasive service, which cannot otherwise be properly handled by conventional soft seated ball valves owing to the limited heat resistance characteristics and mechanical properties of their soft seats. "FILLTITE®" is a specially reinforced ball seat, made using more carbon based fillers into PTFE than conventional carbon-filled PTFE, which greatly improves heat and abrasion resistances. The material shows excellent operability, durability, chemical resistance, and sealing performance at a high temperature of 300°C. In addition, the ball seat is replaceable with most of our conventional ball seats, so it also has a cost advantage.

*Temperature is limited to 425°C (797°F) for SCTDZ3H(M), 6H(M).

2. Unconditional firesafe provision

While metal or hard graphite seats are extremely heat resistant, other sealing components such as gland packings and flange gaskets are made of flexible graphite—another heat-resistant material—and so, no part of the valve will be affected by extraordinarily heated environments. Furthermore, the provision of an anti-static device is not required, because of inter-component electric conductivity.

3. Maintenance ease

The split-body construction of the valve body provides the convenience of easy maintenance, which is a critical requirement for handling slurries and other viscous fluids.

4. Valve automation

The quarter-turn valve drive mechanism makes the mounting of valve automation measures such as electric and pneumatic actuators technically easier. KITZ floating ball valves employ integral actuator mounting pads, complying with ISO 5211 and CAPI, for easy, safe, and assured on-the-spot actuator mounting without disassembly of valve glands.

5. High flow efficiency

The full port design provides maximized and linearized flow characteristics with minimal pressure loss as the line flow travels through the valve bore. This is a necessary design requirement, particularly for assuring trouble-free service of slurries and other viscous fluids.

6. Metal seated ball valves (Trim 5H/6H)

Rigid construction with full metallic contact between the ball and the seats and high durability of the trim materials make KITZ metal seated ball valves ideally suited to highly abrasive services that handle slurries and other viscous fluids.



● Trim materials

Valve Design		Floating Ball Valve	
Trim symbol	5H	6H	
Temp.	300°C	500°C *3	
	572°F	932°F *3	
Seat leakage*1			
ANSI FCI 70-2 Class VI			
Parts	Ball	ASTM A276 Type 316 or ASTM A351 Gr.CF8M + Cr plated	ASTM A276 Type 316 or A351 Gr.CF8M + SFNi *2
	Ball seat	316SS + SFNi *2	316SS + SFNi *2
	Stem	A 564 Type 630	A 564 Type 630

*1 Maximum allowable seat leakage *2 Ni-Cr alloy thermal spraying
*3 Temperature is limited to 425°C (797°F) for SCTDZ6H(M)

● A durable metal seat design and material also provide fully guaranteed throttling service performance, which makes the KITZ metal seated ball valves function as reliable control valves.

● Bidirectional flow.

Caution:

● Use a gear operator or a valve actuator to fix the valve position when used for throttling service.

7. Carbon seated ball valves (Trim 3H)

● Bi-directional flow.

● Recommended for low abrasion service.

Valve Design		Floating Ball Valve	
Trim symbol	3H		
Temp.	500°C *5		
	932°F *5		
Seat leakage*1			
ANSI FCI 70-2 Class VI			
Parts	Ball	ASTM A276 Type 304*1 or A351 Gr.CF8*2	
	Ball seat	Cabon + JIS SUS329J1*3	
	Stem	ASTM A276 Type 304*4	

*1 Maximum allowable seat leakage *2 Shell material CF8M; Ball Type 316 or CF8M
*3 Equivalent to AISI Type 329 *4 Shell material CF8M; Stem Type 316
*5 Temperature is limited to 425°C (797°F) for SCTD3H(M).

Caution:

● Not recommended for throttling service.

● Not recommended for high abrasion service.

● Maximum working temperature for oxidizing service, such as high-temperature air, is 450°C (842°F).

8. FILLTITE® seated ball valves (Trim 1H)

● Highest heat resistance among PTFE-based materials.

Valve Design		Floating Ball Valve	
Trim symbol	1H		
Temp.	300°C		
	572°F		
Parts	Ball	ASTM A276 Type 304*1 or A351 Gr.CF8*1	
	Ball seat	FILLTITE® PTFE	
	Stem	ASTM A276 Type 304*2 ASTM A276 Type 316*2	

*1 Shell material CF8M; Ball Type 316 or CF8M

*2 Shell material CF8M; Stem Type 316



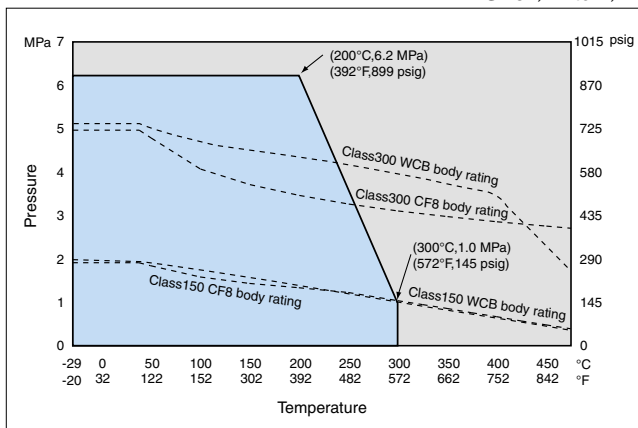
Ball Valve

Technical Data

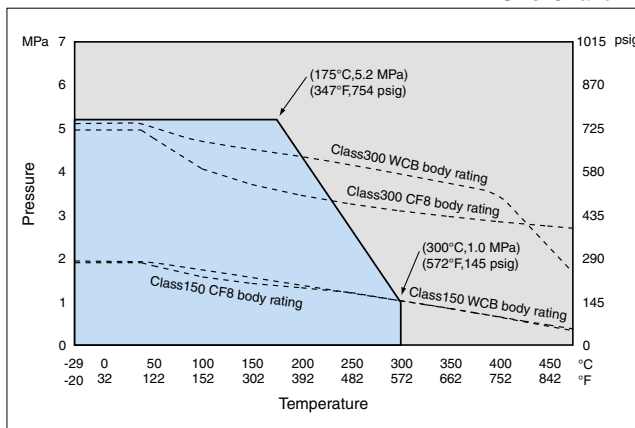
Pressure - Temperature Rating

● FILLTITE® seated floating ball valves: Trim 1H

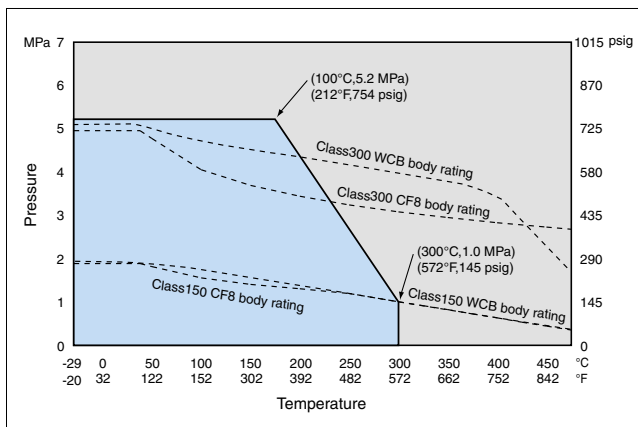
Size: 1/2^B to 2 1/2^B



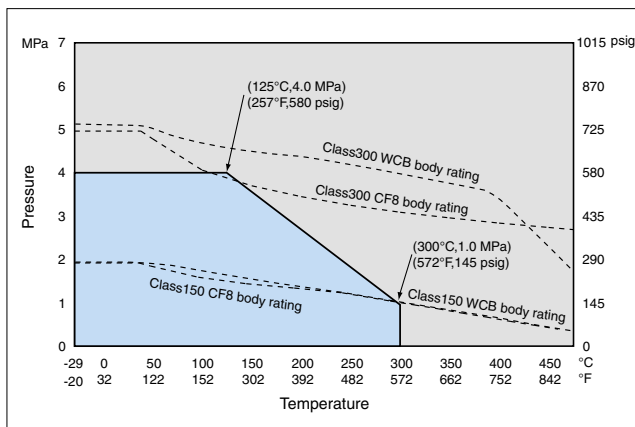
Size: 3^B and 4^B



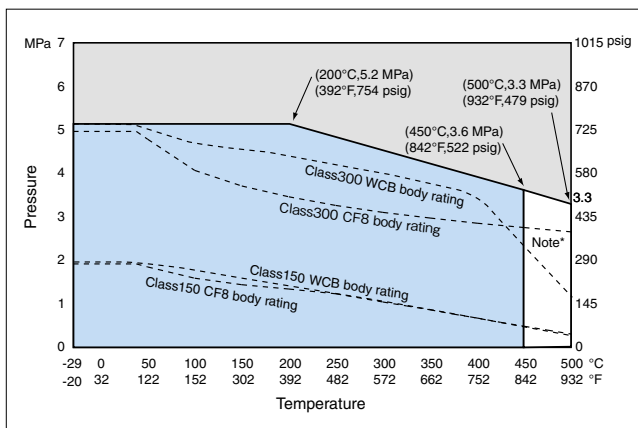
Size: 5^B and 6^B



Size: 8^B and 10^B



● Hard graphite seated floating ball valves: Trim 3H



Note* Maximum working temperature for oxidizing service, such as high temperature air, is 450°C (842°F).

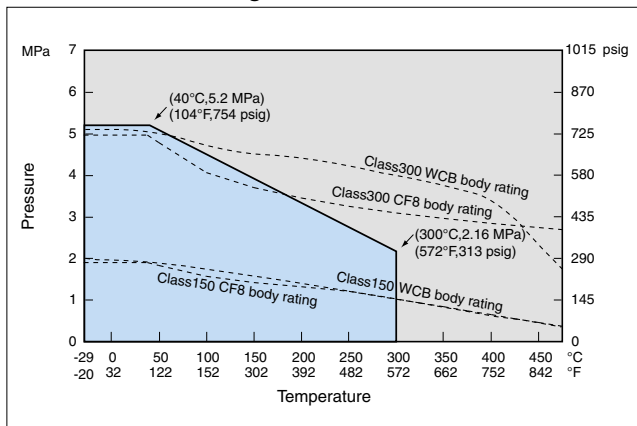
Note: Temperature is limited to 425°C (797°F) for SCTDZ3H(M).

Note: 3H/5H/6H Serviceable temperature terminates at 300°C (572°F) for JIS 10K and at 425°C (797°F) for JIS 20K.

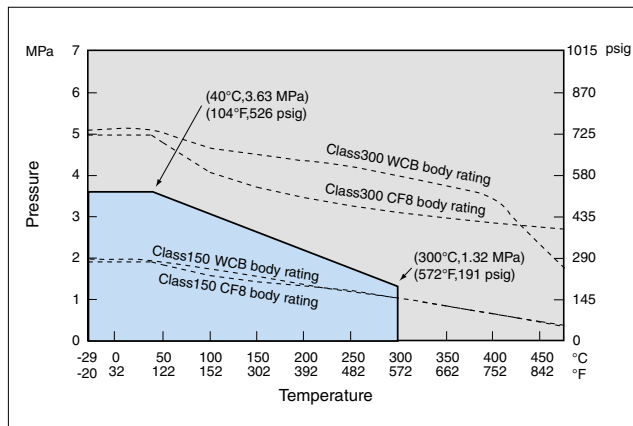
Technical Data

Pressure - Temperature Rating

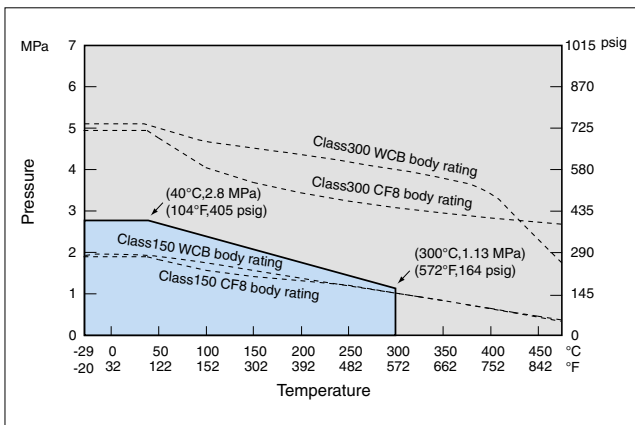
● Metal seated floating ball valves: Trim 5H Size: 1/2^B to 1 1/4^B



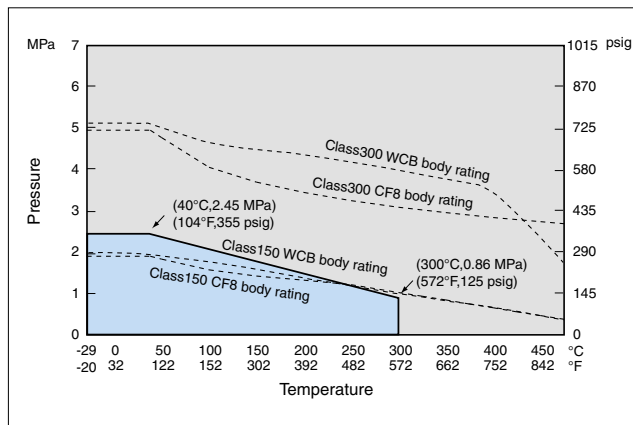
Size: 1 1/2^B and 2^B



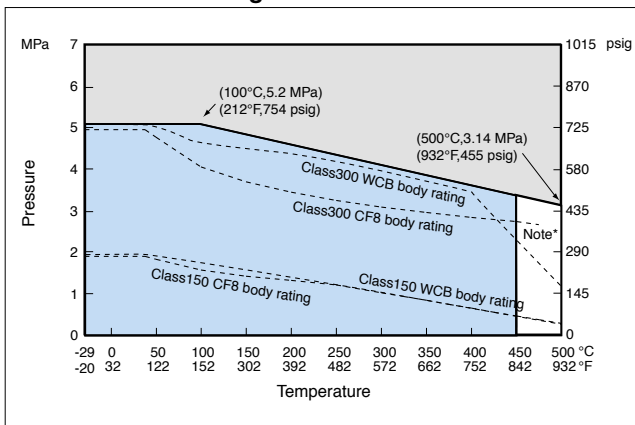
Size: 2 1/2^B to 4^B



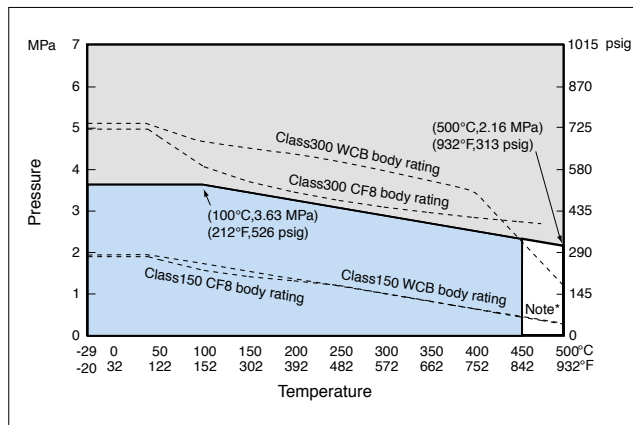
Size: 5^B to 8^B



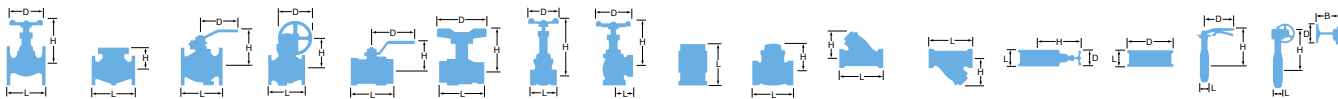
● Metal seated floating ball valves: Trim 6H Size: 1/2^B to 5^B










Size: 6^B to 8^B

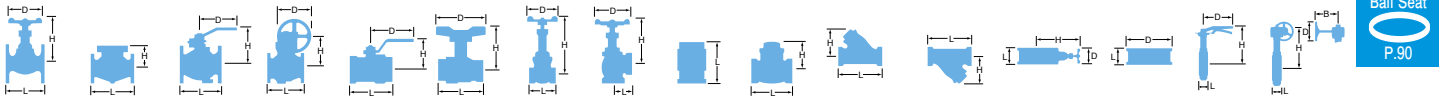


Note: Maximum working temperature for oxidizing service, such as high temperature air, is 450°C (842°F).
Note: Temperature is limited to 425°C (797°F) for SCTDZ6H(M).



TYPE		FLOATING BALL				FLOATING BALL				FLOATING BALL				FLOATING BALL				FLOATING BALL			
Ball Valve																					
FIG		T				AKT				TT				TO				TG			
PRESSURE		TYPE 400				TYPE 400				TYPE 400				TYPE 400				10K			
END CONNECTION		BS21 (JIS B0203)				ASME B1.20.1				BS21 (JIS B0203)				BS21 (JIS B0203)				BS21 (JIS B0203)			
DIMENSIONS		inch	mm	L	H	D	L	H	D	L	H	D	L	H	D	L	H	D			
	1/4	8	50	45	60	50	39	60	50	41	65	59	45	60	50	45	60	50			
	3/8	10	50	45	60	50	39	60	50	41	65	60	45	60	50	45	60	50			
	1/2	15	65	45	80	65	39	80	65	44	80	74	45	80	65	45	80	65			
	3/4	20	68	50	80	68	42	80	68	48	80	80	50	80	68	50	80	68			
	1	25	79	55	110	79	46	110	79	55	90	94	55	110	79	55	110	79			
	1 1/4	32	86	60	110	86	51	110	86	61	105	-	-	-	86	60	110	86			
	1 1/2	40	96	65	110	96	56	110	96	66	105	-	-	-	96	65	110	96			
	2	50	109	75	140	109	65	140	109	80	120	-	-	-	109	75	140	109			
	2 1/2	65	127	91	200	127	91	200	-	-	-	-	-	-	127	91	200	127			
	3	80	153	105	300	153	105	300	-	-	-	-	-	-	153	105	300	153			
	4	100	179	124	400	179	126	400	-	-	-	-	-	-	-	-	-	-			
BODY		Forged Brass / Cast Bronze				Forged Brass / Cast Bronze				Forged Brass				Forged Brass				Forged Brass			
CAP		Forged Brass / Cast Bronze				Forged Brass / Cast Bronze				Forged Brass				Forged Brass				Forged Brass			
STEM		Special Brass				Special Brass				Special Brass				Special Brass				Special Brass			
BALL		Forged Brass / Stainless Steel				Forged Brass / Stainless Steel				Forged Brass / Stainless Steel				Forged Brass				Forged Brass / Stainless Steel			
SEAT		PTFE				PTFE				PTFE				PTFE				PTFE			
		Standard Port				Standard Port				Standard Port				Standard Port				Standard Port			

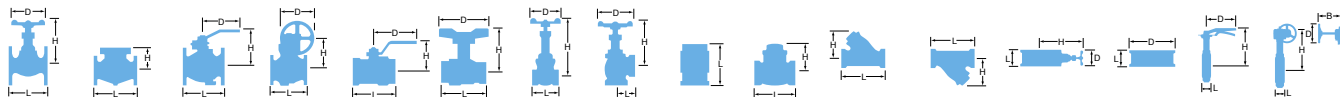
TYPE		FLOATING BALL				FLOATING BALL				FLOATING BALL				FLOATING BALL				FLOATING BALL			
Ball Valve																					
FIG		TB				TL				TLT				TFJ				TM			
PRESSURE		10K				TYPE 400				TYPE 400				TYPE 150				TYPE 400			
END CONNECTION		JIS B2240				BS21 (JIS B0203)				BS21 (JIS B0203)				BS21 (JIS B0203)				BS21 (JIS B0203)			
DIMENSIONS		inch	mm	L	H	D	L	H	D	L	H	D	L	H	D	L	H	D			
	3/8	10	-	-	-	-	-	-	-	-	-	-	-	-	-	56	45	60			
	1/2	15	110	85	130	56	75	80	56	79	82	62	53	65	60	45	80	60			
	3/4	20	120	88	130	65	79	80	65	83	82	73	58	65	68	49	80	68			
	1	25	130	95	160	78	83	110	78	90	94	85	67	90	80	55	110	80			
	1 1/4	32	140	100	160	86	98	110	86	105	94	98	72	90	86	60	110	86			
	1 1/2	40	165	115	230	96	102	110	96	109	94	108	90	110	101	65	110	101			
	2	50	180	122	230	109	109	140	109	124	120	124	98.5	110	117	75	140	117			
	2 1/2	65	190	153	400	-	-	-	-	-	-	-	-	-	136	91	200	136			
	3	80	200	162	400	-	-	-	-	-	-	-	-	-	160	105	300	160			
	4	100	230	190	460	-	-	-	-	-	-	-	-	-	-	-	-	-			
BODY		Cast Bronze				Cast Bronze				Cast Bronze				Forged Brass / Cast Bronze				Forged Brass			
CAP		Cast Bronze				Cast Bronze				Cast Bronze				Forged Brass / Cast Bronze				Forged Brass			
STEM		Special Brass				Special Brass				Special Brass				Special Brass				Special Brass			
BALL		Forged Brass / Stainless Steel				Stainless Steel				Stainless Steel				Forged Brass				Forged Brass / Stainless Steel			
SEAT		PTFE				PTFE				PTFE				PTFE				PTFE			
		Full Port				Standard Port				Standard Port				Full Port				Standard Port			



TYPE	FLOATING BALL					FLOATING BALL			FLOATING BALL			FLOATING BALL			3WAY FLOATING BALL		
Ball Valve																	
FIG	TK					AKTK			TKT			TKW			TN		
PRESSURE	TYPE 600					TYPE 600			TYPE 600			TYPE 600			TYPE 400		
END CONNECTION	BS21 (JIS B0203)					BS21 (JIS B0203)			BS21 (JIS B0203)			BS21 (JIS B0203)			BS21 (JIS B0203)		
DIMENSIONS	inch	mm	L	H	D	L	H	D	L	H	D	L	H	D	L	H	D
	1/8	6	32	31	60	—	—	—	32	23	35	32	25	35	—	—	—
	1/4	8	39	31	60	39	31	60	39	23	35	39	25	35	40	30	60
	3/8	10	44	36	70	44	36	70	44	27	40	44	29	40	46	34	70
	1/2	15	56.5	41	85	56.5	41	85	56.5	31	60	56.5	35	55	67	45	80
	3/4	20	59	44	85	59	44	85	59	34	60	59	39	55	68	48	80
	1	25	71	48	100	71	48	100	71	42	76	71	40.8	69	79	55	110
	1 1/4	32	78	54	100	78	54	100	78	48	76	—	—	—	89	60	110
	1 1/2	40	83	65	125	83	65	125	83	53	100	—	—	—	100	65	110
	2	50	100	72	125	100	72	125	100	60	100	—	—	—	115	75	140
2 1/2	65	—	—	—	—	—	—	—	—	—	—	—	—	138	91	200	
3	80	—	—	—	—	—	—	—	—	—	—	—	—	166	105	300	
BODY	Forged Brass					Forged Brass			Forged Brass			Forged Brass			Forged Brass / Cast Bronze		
CAP	Brass Rod					—			Brass			Brass			Forged Brass		
STEM	Special Brass					Special Brass			Special Brass			Special Brass			Special Brass		
BALL	Forged Brass					Forged Brass			Forged Brass			Forged Brass			Forged Brass		
SEAT	G/F PTFE					G/F PTFE			G/F PTFE			G/F PTFE			PTFE		
	Reduced Port					Reduced Port			Reduced Port			Reduced Port			Standard Port		

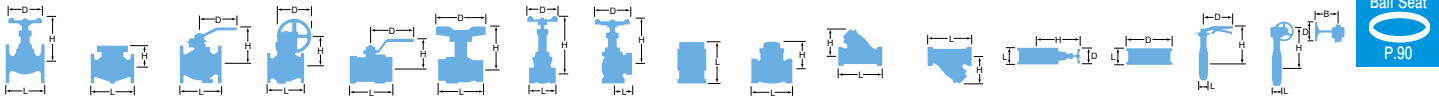
TYPE	3WAY FLOATING BALL			3WAY FLOATING BALL			3WAY FLOATING BALL			3 PIECE FLOATING BALL			FLOATING BALL				
Ball Valve																	
FIG	AKTN			T4T			T4L			AK3TM			AKTAF				
PRESSURE	TYPE 400			TYPE 400			TYPE 400			TYPE 600			TYPE 600				
END CONNECTION	BS21 (JIS B0203)			BS21 (JIS B0203)			BS21 (JIS B0203)			ASME B1.20.1			ASME B1.20.1				
DIMENSIONS	inch	mm	L	H	D	L	H	D	L	H	D	L	H	D	L	H	D
	1/4	8	40	30	60	—	—	—	—	—	—	1.9	1.5	3.2	41	39	82
	3/8	10	46	34	70	—	—	—	—	—	—	1.9	1.5	3.2	42	39	82
	1/2	15	67	45	80	70	52	130	70	52	130	61	42	82	53	42	82
	3/4	20	68	48	80	85	56	130	85	56	130	70	51	100	60	51	100
	1	25	79	55	110	100	63	150	100	63	150	83	59	130	72	59	130
	1 1/4	32	89	60	110	115	68	150	115	68	150	99	64	130	82	64	130
	1 1/2	40	100	65	110	130	94.5	230	130	94.5	230	117	73	150	92	73	150
	2	50	115	75	140	150	102	230	150	102	230	139	80	150	105	80	150
	2 1/2	65	138	91	200	—	—	—	—	—	—	—	—	—	—	—	—
3	80	166	105	300	—	—	—	—	—	—	—	—	—	—	—	—	—
BODY	Forged Brass / Cast Bronze			Cast Bronze			Cast Bronze			Forged Brass			Forged Brass				
CAP	Forged Brass			Forged Brass			Forged Brass			Forged Brass			Forged Brass				
STEM	Special Brass			Special Brass			Special Brass			Special Brass			Special Brass				
BALL	Forged Brass			Forged Brass			Forged Brass			Forged Brass			Forged Brass				
SEAT	PTFE			PTFE			PTFE			PTFE			PTFE				
	Standard Port			Standard Port			Standard Port			Full Port			Full Port				

Brass & Bronze
Cast Iron
Ductile Iron
Stainless Steel
Carbon Steel
Butterfly Valve
Ball Valve
Ball Valve Seal
Actuated Valve



TYPE	FLOATING BALL					FLOATING BALL			FLOATING BALL			FLOATING BALL			FLOATING BALL		
Ball Valve																	
FIG	AKTAFM					SZA			AKSZA			PN40SZA			AKSZAW		
PRESSURE	TYPE 600					TYPE 600			TYPE 600			PN40			TYPE 600		
END CONNECTION	ASME B1.20.1					BS21 (JIS B0203)			ASME B1.20.1			BS21 (JIS B0203)			ASME B1.20.1		
DIMENSIONS	inch	mm	L	H	D	L	H	D	L	H	D	L	H	D	L	H	D
	1/4	8	41	39	82	42	37	70	42	37	70	-	-	-	42	34	55
	3/8	10	42	39	82	42	37	70	42	37	70	-	-	-	42	34	55
	1/2	15	53	42	82	53	40	80	53	40	80	53	40	80	53	40	70
	3/4	20	60	51	100	60	44	80	60	44	80	60	43	80	60	44	70
	1	25	72	59	130	72	50	110	72	50	110	72	50	110	72	53	100
	1 1/4	32	82	64	130	84	55	110	84	55	110	84	55	110	84	58	100
	1 1/2	40	92	73	150	92	65	150	92	65	150	92	65	150	92	74	130
	2	50	105	80	150	110	72	150	110	72	150	110	72	150	110	81	130
	2 1/2	65	-	-	-	138	101	200	138	101	200	-	-	-	-	-	-
	3	80	-	-	-	167	113	300	167	113	300	-	-	-	-	-	-
	4	100	-	-	-	193	131	300	193	131	300	-	-	-	-	-	-
BODY	Forged Brass					Forged Brass / Cast Bronze			Forged Brass / Cast Bronze			Forged Brass			Forged Brass		
CAP	Forged Brass					Forged Brass / Cast Bronze			Forged Brass / Cast Bronze			Forged Brass			Forged Brass		
STEM	Stainless Steel					Brass Rod			Brass Rod			Brass Rod			Brass Rod		
BALL	Stainless Steel					Forged Brass / Stainless Steel			Forged Brass / Stainless Steel			Forged Brass			Forged Brass		
SEAT	PTFE					PTFE			PTFE			PTFE			PTFE		
	Full Port					Full Port			Full Port			Full Port			Full Port		

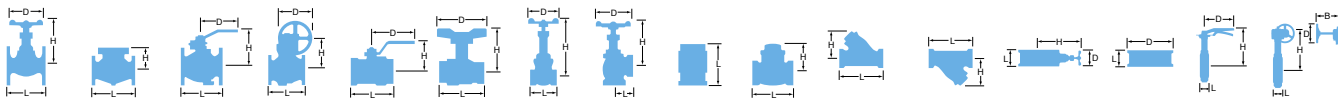
TYPE	FLOATING BALL					FLOATING BALL			FLOATING BALL			FLOATING BALL			FLOATING BALL		
Ball Valve																	
FIG	AKTAFLL					10FCT			10FCTB			10FCTR			125FCTB		
PRESSURE	TYPE 600					10K			10K			10K			Class 125		
END CONNECTION	ASME B1.20.1					BS21 (JIS B0203)			JIS B2239			JIS B2239			ASME B16.1		
DIMENSIONS	inch	mm	L	H	D	L	H	D	L	H	D	L	H	D	L	H	D
	1/4	8	41	39	81	-	-	-	-	-	-	-	-	-	-	-	-
	3/8	10	42	39	81	72	71	130	-	-	-	-	-	-	-	-	-
	1/2	15	53	42	81	80	102	130	110	102	130	-	-	-	-	-	-
	3/4	20	60	51	100	85	105	130	120	105	130	-	-	-	-	-	-
	1	25	72	58	130	95	125	160	130	124	160	-	-	-	-	-	-
	1 1/4	32	82	64	130	120	130	160	140	128	160	-	-	-	-	-	-
	1 1/2	40	92	73	150	120	115	230	165	114	230	-	-	-	-	-	-
	2	50	105	80	150	140	120	230	180	121	230	-	-	-	178	120	230
	2 1/2	65	-	-	-	160	155	400	190	154	400	-	-	-	190	155	400
	3	80	-	-	-	182	165	400	200	163	400	-	-	-	203	165	400
	4	100	-	-	-	-	-	-	230	199	460	-	-	-	229	200	460
	5	125	-	-	-	-	-	-	300	219	460	250	200	460	-	-	-
	6	150	-	-	-	-	-	-	340	292	1000	270	220	460	394	295	1000
	8	200	-	-	-	-	-	-	450	352	1500	290	295	1000	457	355	1500
	10	250	-	-	-	-	-	-	-	-	-	330	355	1500	-	-	-
BODY	Forged Brass					Cast Iron			Cast Iron			Cast Iron			Cast Iron		
CAP	Forged Brass					Cast Iron			Cast Iron			Cast Iron			Cast Iron		
STEM	Special Brass					Stainless Steel			Stainless Steel			Stainless Steel			Stainless Steel		
BALL	Forged Brass					Stainless Steel			Stainless Steel			Stainless Steel			Stainless Steel		
SEAT	PTFE					PTFE			PTFE			PTFE			PTFE		
	Full Port					Full Port			Full Port			Reduced Port			Full Port		



TYPE	FLOATING BALL			3WAY FLOATING BALL			3WAY FLOATING BALL			FLOATING BALL			FLOATING BALL					
Ball Valve																		
FIG	125FCTR			10FCTB2L			10FCTR2L			STZ			20ST					
PRESSURE	Class 125			10K			10K			TYPE 400			20K					
END CONNECTION	ASME B16.18			JIS B2239			JIS B2239			BS21 (JIS B0203)			BS21 (JIS B0203)					
DIMENSIONS	inch	mm	L	H	D	L	H	D	L	H	D	L	H	D	L	H	D	
			1/4	8	-	-	-	-	-	-	-	-	-	46	38	80	-	-
	3/8	10	-	-	-	-	-	-	-	-	-	51	38	80	-	-	-	
	1/2	15	-	-	-	-	-	-	-	-	-	57	42	100	75	106	130	
	3/4	20	-	-	-	-	-	-	-	-	-	65	49	130	80	106	130	
	1	25	-	-	-	-	-	-	-	-	-	76	52	130	90	107	130	
	1 1/4	32	-	-	-	-	-	-	-	-	-	86	57	130	105	129	160	
	1 1/2	40	-	-	-	210	115	230	-	-	-	95	63	130	115	133	160	
	2	50	-	-	-	220	120	230	-	-	-	115	68	150	130	114	230	
	2 1/2	65	-	-	-	250	155	400	-	-	-	-	-	-	-	-	-	-
	3	80	-	-	-	260	165	400	-	-	-	-	-	-	-	-	-	-
4	100	-	-	-	330	200	460	-	-	-	-	-	-	-	-	-	-	
5	125	-	-	-	-	-	-	370	205	460	-	-	-	-	-	-	-	
6	150	267	220	460	-	-	-	430	225	460	-	-	-	-	-	-	-	
8	200	292	295	1000	-	-	-	540	295	1000	-	-	-	-	-	-	-	
10	250	330	355	1500	-	-	-	-	-	-	-	-	-	-	-	-	-	
BODY	Cast Iron			Cast Iron			Cast Iron			Ductile Iron			Ductile Iron					
CAP	Cast Iron			Cast Iron			Cast Iron			Ductile Iron			Ductile Iron					
STEM	Stainless Steel			Stainless Steel			Stainless Steel			Special Brass			Stainless Steel					
BALL	Stainless Steel			Stainless Steel			Stainless Steel			Forged Brass			Stainless Steel					
SEAT	PTFE			PTFE			PTFE			G/F PTFE			HYPATITE® PTFE					
	Reduced Port			Full Port			Reduced Port			Reduced Port			Reduced Port					

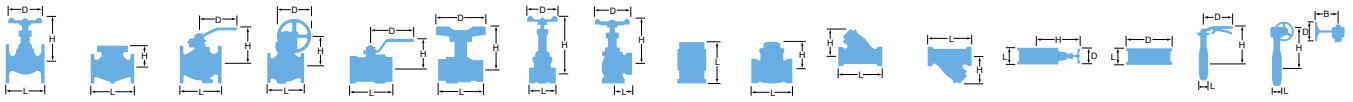
TYPE	FLOATING BALL			3WAY FLOATING BALL			3WAY FLOATING BALL			3WAY FLOATING BALL			3WAY FLOATING BALL				
Ball Valve																	
FIG	10STBF			10STB4TAF			10STB4LAF			10STR4TAF			10STR4LAF				
PRESSURE	10K			10K			10K			10K			10K				
END CONNECTION	JIS B2239			JIS B2239			JIS B2239			JIS B2239			JIS B2239				
DIMENSIONS	inch	mm	L	H	D	L	H	D	L	H	D	L	H	D	L	H	D
			1/2	15	108	106	130	-	-	-	-	-	-	-	-	-	-
	3/4	20	117	109	130	-	-	-	-	-	-	-	-	-	-	-	-
	1	25	127	130	160	-	-	-	-	-	-	-	-	-	-	-	-
	1 1/4	32	140	135	160	-	-	-	-	-	-	-	-	-	-	-	-
	1 1/2	40	165	115	230	180	143	400	180	143	400	-	-	-	-	-	-
	2	50	178	120	230	200	152	400	200	152	400	-	-	-	-	-	-
	2 1/2	65	190	153	400	240	183	460	240	183	460	-	-	-	-	-	-
	3	80	203	162	400	260	190	460	260	190	460	-	-	-	-	-	-
4	100	229	199	460	330	259	1000	330	259	1000	-	-	-	-	-	-	
5	125	356	219	460	-	-	-	-	-	-	340	267	1000	340	267	1000	
6	150	394	293	1000	-	-	-	-	-	-	400	289	1000	400	289	1000	
8	200	457	352	1500	-	-	-	-	-	-	450	334	1500	450	334	1500	
BODY	Ductile Iron			Ductile Iron			Ductile Iron			Ductile Iron			Ductile Iron				
CAP	Ductile Iron			Ductile Iron			Ductile Iron			Ductile Iron			Ductile Iron				
STEM	Stainless Steel			Stainless Steel			Stainless Steel			Stainless Steel			Stainless Steel				
BALL	Stainless Steel			Stainless Steel			Stainless Steel			Stainless Steel			Stainless Steel				
SEAT	HYPATITE® PTFE			HYPATITE® PTFE			HYPATITE® PTFE			HYPATITE® PTFE			HYPATITE® PTFE				
	Full Port			Full Port			Full Port			Reduced Port			Reduced Port				

Bronze & Brass
 Cast Iron
 Ductile Iron
 Stainless Steel
 Carbon Steel
 Butterfly Valve
 Ball Valve
 Ball Valve Seat
 Actuated Valve



TYPE	FLOATING BALL					FLOATING BALL			FLOATING BALL			FLOATING BALL			FLOATING BALL		
Ball Valve																	
FIG	10STLBF					20STLB			UTK			UTKM			UTKW		
PRESSURE	10K					20K			TYPE 600			TYPE 600			TYPE 600		
END CONNECTION	JIS B2239					JIS B2239			BS21 (JIS B0203)			BS21 (JIS B0203)			BS21 (JIS B0203)		
DIMENSIONS	inch	mm	L	H	D	L	H	D	L	H	D	L	H	D	L	H	D
	1/4	8	—	—	—	—	—	—	39	31	60	39	31	60	39	25	35
	3/8	10	—	—	—	—	—	—	44	36	70	44	36	70	44	29	40
	1/2	15	108	106	130	140	106	130	56.5	41	85	56.5	41	85	56.5	35	55
	3/4	20	117	109	130	152	109	130	59	44	85	59	44	85	59	39	55
	1	25	127	130	160	165	130	160	71	48	100	71	48	100	71	41	69
	1 1/4	32	140	135	160	178	135	160	78	54	100	78	54	100	—	—	—
	1 1/2	40	165	115	230	190	115	230	83	65	125	83	65	125	—	—	—
	2	50	178	120	230	216	120	230	100	72	125	100	72	125	—	—	—
	2 1/2	65	190	153	400	241	153	400	—	—	—	—	—	—	—	—	—
	3	80	203	162	400	283	162	400	—	—	—	—	—	—	—	—	—
	4	100	229	199	460	305	241	750	—	—	—	—	—	—	—	—	—
	5	125	356	219	460	—	—	—	—	—	—	—	—	—	—	—	—
	6	150	394	293	1000	403	293	1000	—	—	—	—	—	—	—	—	—
	8	200	457	352	1500	502	352	1500	—	—	—	—	—	—	—	—	—
BODY	Ductile Iron					Ductile Iron			Stainless Steel			Stainless Steel			Stainless Steel		
CAP	Ductile Iron					Ductile Iron			—			—			—		
STEM	Stainless Steel					Stainless Steel			Stainless Steel			Stainless Steel			Stainless Steel		
BALL	Stainless Steel					Stainless Steel			Stainless Steel			Stainless Steel			Stainless Steel		
SEAT	PTFE					HYPATITE® PTFE			G/F PTFE			G/F PTFE			G/F PTFE		
	Full Port					Full Port			Reduced Port			Reduced Port			Reduced Port		

TYPE	FLOATING BALL					FLOATING BALL			FLOATING BALL			FLOATING BALL			FLOATING BALL		
Ball Valve																	
FIG	UTKMW					UTFM			UTH			UTHM			UTHL		
PRESSURE	TYPE 600					TYPE 1000			TYPE 800			TYPE 800			TYPE 1000		
END CONNECTION	BS21 (JIS B0203)					BS21 (JIS B0203)			BS21 (JIS B0203)			BS21 (JIS B0203)			BS21 (JIS B0203)		
DIMENSIONS	inch	mm	L	H	D	L	H	D	L	H	D	L	H	D	L	H	D
	1/4	8	39	25	35	—	—	—	—	—	—	—	—	—	—	—	—
	3/8	10	44	29	40	—	—	—	—	—	—	—	—	—	—	—	—
	1/2	15	56.5	35	55	62	53	100	60	47	100	60	48	100	60	76	100
	3/4	20	59	39	55	73	63	130	70	53	100	70	54	100	70	80	100
	1	25	71	41	69	85	67	130	80	63	130	80	64	130	80	85	130
	1 1/4	32	—	—	—	98	75	150	95	67	130	95	68	130	95	99	130
	1 1/2	40	—	—	—	108	81	150	108	78	150	108	79	150	108	105	150
	2	50	—	—	—	124	102	200	124	84	150	124	85	150	124	113	150
BODY	Stainless Steel					Stainless Steel			Stainless Steel			Stainless Steel			Stainless Steel		
CAP	—					Stainless Steel			Stainless Steel			Stainless Steel			Stainless Steel		
STEM	Stainless Steel					Stainless Steel			Stainless Steel			Stainless Steel			Stainless Steel		
BALL	Stainless Steel					Stainless Steel			Stainless Steel			Stainless Steel			Stainless Steel		
SEAT	G/F PTFE					HYPATITE® PTFE			PTFE			PTFE			HYPATITE® PTFE		
	Reduced Port					Full Port			Reduced Port			Reduced Port			Reduced Port		



TYPE	3WAY FLOATING BALL				3WAY FLOATING BALL				3 PIECE FLOATING BALL			3 PIECE FLOATING BALL			FLOATING BALL		
Ball Valve																	
FIG	UTH4LM				UTH4TM				U3TZM			SWU3TZM			10UT		
PRESSURE	TYPE 800				TYPE 800				TYPE 1000			TYPE 1000			10K		
END CONNECTION	BS21 (JIS B0203)				BS21 (JIS B0203)				BS21 (JIS B0203)			JIS B2316			BS21 (JIS B0203)		
DIMENSIONS	inch	mm	L	H	D	L	H	D	L	H	D	L	H	D	L	H	D
	3/8	10	-	-	-	-	-	-	-	-	-	-	-	-	62	71	130
	1/2	15	69	63	130	69	63	130	63	48	120	63	48	120	65	102	130
	3/4	20	84	65	130	84	65	130	71	60	130	71	60	130	80	105	130
	1	25	96	75.5	150	96	75.5	150	90	69	130	90	69	130	90	124	160
	1 1/4	32	114	79.5	150	114	79.5	150	103	83	150	103	83	150	110	130	160
	1 1/2	40	132	95.5	230	132	95.5	230	110	88	150	110	88	150	120	115	230
	2	50	150	101	230	150	101	230	127	104	180	127	104	180	140	120	230
	2 1/2	65	-	-	-	-	-	-	-	-	-	-	-	-	160	155	400
3	80	-	-	-	-	-	-	-	-	-	-	-	-	182	165	400	
BODY	Stainless Steel				Stainless Steel				Stainless Steel			Stainless Steel			Stainless Steel		
CAP	Stainless Steel				Stainless Steel				Stainless Steel			Stainless Steel			Stainless Steel		
STEM	Stainless Steel				Stainless Steel				Stainless Steel			Stainless Steel			Stainless Steel		
BALL	Stainless Steel				Stainless Steel				Stainless Steel			Stainless Steel			Stainless Steel		
SEAT	HYPATITE® PTFE				HYPATITE® PTFE				HYPATITE® PTFE			HYPATITE® PTFE			PTFE		
	Reduced Port				Reduced Port				Reduced Port			Reduced Port Socket Weld End			Full Port		

TYPE	FLOATING BALL				FLOATING BALL				FLOATING BALL				FLOATING BALL				FLOATING BALL			
Ball Valve																				
FIG	10UTB / G-10UTB				10UTDZ / G-10UTDZ				10UTDZM / G-10UTDZM				20UTDZ				20UTDZM			
PRESSURE	10K				10K				10K				20K				20K			
END CONNECTION	JIS B2220				JIS B2220				JIS B2220				JIS B2220				JIS B2220			
DIMENSIONS	inch	mm	L	H	D	L	H	D	L	H	D	L	H	D	L	H	D			
	1/2	15	110	102	130	108	108	130	108	108	130	140	108	130	140	108	130			
	3/4	20	120	105	130	117	111	130	117	111	130	152	111	130	152	111	130			
	1	25	130	124	160	127	124	160	127	124	160	165	124	160	165	124	160			
	1 1/4	32	140	128	160	140	128	160	140	128	160	178	128	160	178	128	160			
	1 1/2	40	165	115	230	165	134	230	165	134	230	190	134	230	190	134	230			
	2	50	180	120	230	178	143	230	178	143	230	216	143	230	216	143	230			
	2 1/2	65	190	155	400	190	179	400	190	179	400	241	179	400	241	179	400			
	3	80	200	165	400	203	189	400	203	189	400	283	189	400	283	189	400			
	4	100	230	200	460	229	224	460	229	224	460	305	251	750	305	251	750			
	5	125	300	220	460	356	240	460	356	240	460	381	267	750	381	267	750			
6	150	340	295	1000	394	315	1000	394	315	1000	403	315	1000	403	315	1000				
8	200	450	355	1500	457	406	1500	457	406	1500	502	406	1500	502	406	1500				
10	250	533	477	500	533	448	500	533	448	500	-	-	-	-	-	-				
BODY	Stainless Steel				Stainless Steel				Stainless Steel				Stainless Steel				Stainless Steel			
BONNET / CAP	Stainless Steel				Stainless Steel				Stainless Steel				Stainless Steel				Stainless Steel			
STEM	Stainless Steel				Stainless Steel				Stainless Steel				Stainless Steel				Stainless Steel			
BALL	Stainless Steel				Stainless Steel				Stainless Steel				Stainless Steel				Stainless Steel			
SEAT	HYPATITE® PTFE				HYPATITE® PTFE				HYPATITE® PTFE				HYPATITE® PTFE				HYPATITE® PTFE			
	Full Port SIZE:10 Gear operation type				Full Port SIZE:10 Gear operation type				Full Port SIZE:10 Gear operation type				Full Port				Full Port			

Brass & Bronze

Cast Iron

Ductile Iron

Stainless Steel

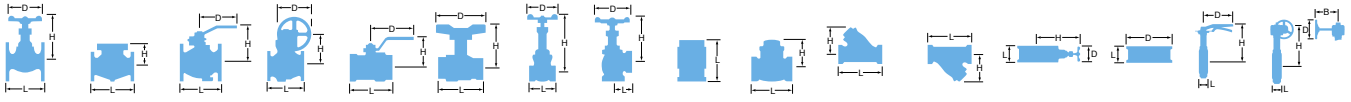
Carbon Steel

Butterfly Valve

Ball Valve

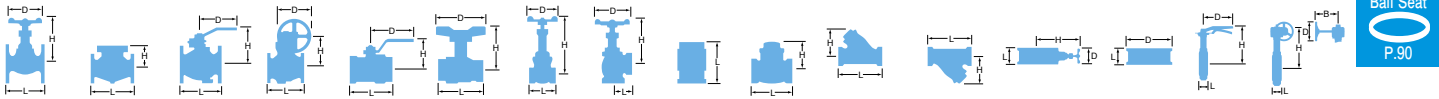
Ball Valve Seal

Actuated Valve



TYPE	FLOATING BALL					FLOATING BALL			FLOATING BALL			FLOATING BALL			FLOATING BALL		
Ball Valve																	
FIG	10UTR					20UTR			150UTB / G-150UTB			150UTBM / G-150UTBM			150UTDZ / G-150UTDZ		
PRESSURE	10K					20K			Class 150			Class 150			Class 150		
END CONNECTION	JIS B2220					JIS B2220			ASME B16.5			ASME B16.5			ASME B16.5		
DIMENSIONS	inch	mm	L	H	D	L	H	D	L	H	D	L	H	D	L	H	D
	1/2	15	-	-	-	-	-	-	108	102	130	108	102	130	108	108	130
	3/4	20	-	-	-	-	-	-	117	105	130	117	105	130	117	111	130
	1	25	-	-	-	-	-	-	127	124	160	127	124	160	127	124	160
	1 1/4	32	-	-	-	-	-	-	-	-	-	-	-	-	140	128	160
	1 1/2	40	-	-	-	-	-	-	165	115	230	165	115	230	165	134	230
	2	50	178	115	230	216	115	230	178	120	230	178	120	230	178	143	230
	2 1/2	65	190	120	230	-	-	-	190	155	400	190	155	400	190	179	400
	3	80	203	155	400	283	155	400	203	165	400	203	165	400	203	189	400
	4	100	229	165	400	305	165	400	229	200	460	229	200	460	229	224	460
	5	125	250	200	460	-	-	-	356	220	460	356	220	460	356	240	460
	6	150	270	220	460	403	260	750	394	295	1000	394	295	1000	394	315	1000
	8	200	290	295	1000	419	295	1000	457	355	1500	457	355	1500	457	406	1500
	10	250	330	355	1500	457	355	1550	533	477	500	533	477	500	533	448	500
BODY	Stainless Steel					Stainless Steel			Stainless Steel			Stainless Steel			Stainless Steel		
CAP	Stainless Steel					Stainless Steel			Stainless Steel			Stainless Steel			Stainless Steel		
STEM	Stainless Steel					Stainless Steel			Stainless Steel			Stainless Steel			Stainless Steel		
BALL	Stainless Steel					Stainless Steel			Stainless Steel			Stainless Steel			Stainless Steel		
SEAT	HYPATITE® PTFE					HYPATITE® PTFE			HYPATITE® PTFE			HYPATITE® PTFE			HYPATITE® PTFE		
	Reduced Port					Reduced Port			Full Port SIZE:10 Gear operation type			Full Port SIZE:10 Gear operation type			Full Port SIZE:10 Gear operation type		

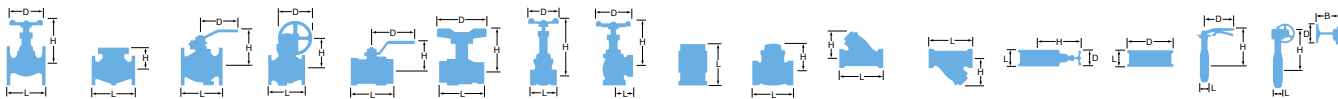
TYPE	FLOATING BALL					FLOATING BALL			FLOATING BALL			FLOATING BALL			FLOATING BALL		
Ball Valve																	
FIG	150UTDZM / G-150UTDZM					300UTDZ			300UTDZM			150UTR			300UTR		
PRESSURE	Class 150					Class 300			Class 300			Class 150			Class 300		
END CONNECTION	ASME B16.5					ASME B16.5			ASME B16.5			ASME B16.5			ASME B16.5		
DIMENSIONS	inch	mm	L	H	D	L	H	D	L	H	D	L	H	D	L	H	D
	1/2	15	108	108	130	140	108	130	140	108	130	-	-	-	-	-	-
	3/4	20	117	111	130	152	111	130	152	111	130	-	-	-	-	-	-
	1	25	127	124	160	165	124	160	165	124	160	-	-	-	-	-	-
	1 1/4	32	140	128	160	-	-	-	-	-	-	-	-	-	-	-	-
	1 1/2	40	165	134	230	190	134	230	190	134	230	-	-	-	-	-	-
	2	50	178	143	230	216	143	230	216	143	230	178	115	230	216	115	230
	2 1/2	65	190	179	400	241	179	400	241	179	400	190	120	230	-	-	-
	3	80	203	189	400	283	189	400	283	189	400	203	155	400	283	155	400
	4	100	229	224	460	305	251	750	305	251	750	229	165	400	305	165	400
	5	125	356	240	460	381	267	750	-	-	-	254	200	460	-	-	-
	6	150	394	315	1000	403	315	1000	403	315	1000	267	220	460	403	260	750
	8	200	457	406	1500	502	406	1500	502	406	1500	292	295	1000	419	295	1000
	10	250	533	448	500	-	-	-	-	-	-	330	355	1500	457	355	1500
BODY	Stainless Steel					Stainless Steel			Stainless Steel			Stainless Steel			Stainless Steel		
CAP	Stainless Steel					Stainless Steel			Stainless Steel			Stainless Steel			Stainless Steel		
STEM	Stainless Steel					Stainless Steel			Stainless Steel			Stainless Steel			Stainless Steel		
BALL	Stainless Steel					Stainless Steel			Stainless Steel			Stainless Steel			Stainless Steel		
SEAT	HYPATITE® PTFE					HYPATITE® PTFE			HYPATITE® PTFE			HYPATITE® PTFE			HYPATITE® PTFE		
	Full Port SIZE:10 Gear operation type					Full Port			Full Port			Reduced Port			Reduced Port		



TYPE	3WAY FLOATING BALL					3WAY FLOATING BALL			3WAY FLOATING BALL			3WAY FLOATING BALL			3WAY FLOATING BALL		
Ball Valve																	
FIG	10UTB2T					10UTB2TM			10UTB2L			10UTR2L			10UTB2LM		
PRESSURE	10K					10K			10K			10K			10K		
END CONNECTION	JIS B2220					JIS B2220			JIS B2220			JIS B2220			JIS B2220		
DIMENSIONS	inch	mm	L	H	D	L	H	D	L	H	D	L	H	D	L	H	D
	1	25	165	124	160	165	124	160	165	124	160	—	—	—	165	124	160
	1½	40	210	115	230	210	115	230	210	115	230	—	—	—	210	115	230
	2	50	220	123	230	220	123	230	220	123	230	—	—	—	220	123	230
	2½	65	250	155	400	250	155	400	250	155	400	—	—	—	250	155	400
	3	80	260	165	400	260	165	400	260	165	400	—	—	—	260	165	400
	4	100	330	200	460	330	200	460	330	200	460	—	—	—	330	200	460
6	150	—	—	—	—	—	—	—	—	—	—	430	220	460	—	—	—
BODY	Stainless Steel					Stainless Steel			Stainless Steel			Stainless Steel			Stainless Steel		
CAP	Stainless Steel					Stainless Steel			Stainless Steel			Stainless Steel			Stainless Steel		
STEM	Stainless Steel					Stainless Steel			Stainless Steel			Stainless Steel			Stainless Steel		
BALL	Stainless Steel					Stainless Steel			Stainless Steel			Stainless Steel			Stainless Steel		
SEAT	HYPATITE® PTFE					HYPATITE® PTFE			HYPATITE® PTFE			HYPATITE® PTFE			HYPATITE® PTFE		
	Full Port					Full Port			Full Port			Reduced Port			Full Port		

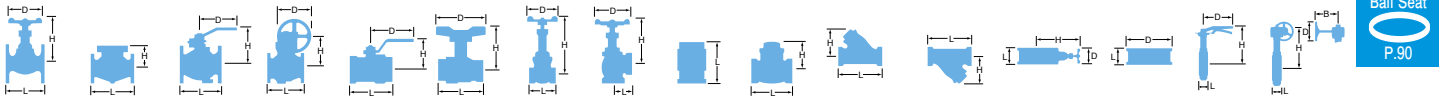
TYPE	3WAY FLOATING BALL					3WAY FLOATING BALL			3WAY FLOATING BALL			3WAY FLOATING BALL			FLOATING BALL		
Ball Valve																	
FIG	10UTB4LA					10UTB4LAM			10UTB4TA			10UTB4TAM			10UTBLN		
PRESSURE	10K					10K			10K			10K			10K		
END CONNECTION	JIS B2220					JIS B2220			JIS B2220			JIS B2220			JIS B2220		
DIMENSIONS	inch	mm	L	H	D	L	H	D	L	H	D	L	H	D	L	H	D
	½	15	120	128	160	120	128	160	120	128	160	120	128	160	140	104	130
	¾	20	140	132	160	140	132	160	140	132	160	140	132	160	152	106	130
	1	25	160	135	160	160	135	160	160	135	160	160	135	160	165	129	160
	1½	40	180	146	400	180	146	400	180	146	400	180	146	400	191	118	230
	2	50	200	155	400	200	155	400	200	155	400	200	155	400	216	124	230
	2½	65	240	185	460	240	185	460	240	185	460	240	185	460	240	157	400
	3	80	260	198	460	260	198	460	260	198	460	260	198	460	250	166	400
4	100	330	267	1000	330	267	1000	330	267	1000	330	267	1000	280	204	460	
6	150	450	335	1500	450	335	1500	450	335	1500	450	335	1500	—	—	—	
BODY	Stainless Steel					Stainless Steel			Stainless Steel			Stainless Steel			Stainless Steel		
CAP	Stainless Steel					Stainless Steel			Stainless Steel			Stainless Steel			Stainless Steel		
STEM	Stainless Steel					Stainless Steel			Stainless Steel			Stainless Steel			Stainless Steel		
BALL	Stainless Steel					Stainless Steel			Stainless Steel			Stainless Steel			Stainless Steel		
SEAT	HYPATITE® PTFE					HYPATITE® PTFE			HYPATITE® PTFE			HYPATITE® PTFE			HYPATITE® PTFE		
	Full Port					Full Port			Full Port			Full Port			Full Port PFA Lining		

Bronze & Brass
 Cast Iron
 Ductile Iron
 Stainless Steel
 Carbon Steel
 Butterfly Valve
 Ball Valve
 Ball Valve Seal
 Actuated Valve



TYPE	FLOATING BALL					FLOATING BALL			FLOATING BALL			FLOATING BALL			FLOATING BALL		
Ball Valve																	
FIG	10UTBT					10UTBJ			10UTBJM			150UTBJ			300UTBJ		
PRESSURE	10K					10K			10K			Class 150			Class 300		
END CONNECTION	JIS B2220					JIS B2220			JIS B2220			ASME B16.5			ASME B16.5		
DIMENSIONS	inch	mm	L	H	D	L	H	D	L	H	D	L	H	D	L	H	D
	1/2	15	—	—	—	110	131	130	110	131	130	110	131	130	140	128	130
	3/4	20	—	—	—	120	135	130	120	135	130	120	135	130	152	132	130
	1	25	105	150	160	130	150	160	130	150	160	130	150	160	165	150	160
	1 1/2	40	125	134	230	165	150	230	165	150	230	165	150	230	—	—	—
	2	50	143	143	230	180	157	230	180	157	230	180	157	230	190	150	230
	2 1/2	65	160	177	400	190	188	400	190	188	400	190	188	400	216	157	230
	3	80	167	187	400	—	—	—	—	—	—	—	—	—	241	187	400
	4	100	176.5	222	460	254	237	460	—	—	—	—	—	—	283	212	400
	5	125	227	242	460	—	—	—	—	—	—	—	—	—	305	238	750
	6	150	265	312	1000	—	—	—	—	—	—	—	—	—	403	261	1000
BODY	Stainless Steel					Stainless Steel			Stainless Steel			Stainless Steel			Stainless Steel		
CAP	Stainless Steel					Stainless Steel			Stainless Steel			Stainless Steel			Stainless Steel		
STEM	Stainless Steel					Stainless Steel			Stainless Steel			Stainless Steel			Stainless Steel		
BALL	Stainless Steel					Stainless Steel			Stainless Steel			Stainless Steel			Stainless Steel		
SEAT	HYPATITE® PTFE					HYPATITE® PTFE			HYPATITE® PTFE			HYPATITE® PTFE			HYPATITE® PTFE		
	Full Port Tank Ball Valve L is dimensions except Tank pad					Full Port Jacketed			Full Port Jacketed			Full Port Jacketed			Full Port Jacketed		

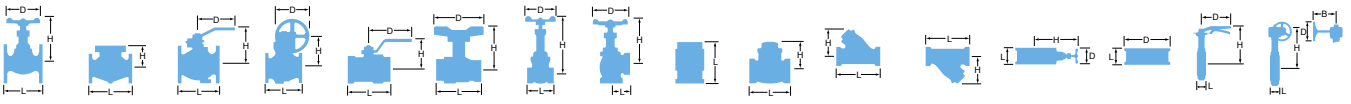
TYPE	LAMBDA PORT			LAMBDA PORT			FLOATING BALL			FLOATING BALL			FLOATING BALL				
Ball Valve																	
FIG	L-10UVC			L-150UVC / G-150UVC			10UTDZ1H			10UTDZ1HM			20UTDZ1H / G-20UTDZ1H				
PRESSURE	10K			Class 150			10K			10K			20K				
END CONNECTION	JIS B2220			ASME B16.18			JIS B2220			JIS B2220			JIS B2220				
DIMENSIONS	inch	mm	L	H	D	L	H	D	L	H	D	L	H	D	L	H	D
	1/2	15	—	—	—	—	—	—	108	108	130	108	108	130	140	108	130
	3/4	20	—	—	—	—	—	—	117	111	130	117	111	130	152	111	130
	1	25	127	181	160	127	181	160	127	124	160	127	124	160	165	124	160
	1 1/4	32	—	—	—	—	—	—	140	128	160	140	128	160	178	128	160
	1 1/2	40	165	199	230	165	198	230	165	134	230	165	134	230	190	134	230
	2	50	178	205	230	178	204	230	178	143	230	178	143	230	216	143	230
	2 1/2	65	190	252	400	190	245	400	190	179	400	190	179	400	241	179	400
	3	80	203	259	400	203	252	400	203	189	400	203	189	400	283	189	400
	4	100	229	292	460	229	283	460	229	251	750	229	251	750	305	258	310
	5	125	—	—	—	—	—	—	—	—	—	—	—	—	381	302	360
	6	150	394	411	1000	394	392	1000	—	—	—	—	—	—	403	332	500
	8	200	457	483	1500	457	460	1500	—	—	—	—	—	—	502	417	500
	10	250	—	—	—	533	446	500	—	—	—	—	—	—	—	—	—
BODY	Stainless Steel			Stainless Steel			Stainless Steel			Stainless Steel			Stainless Steel				
CAP	Stainless Steel			Stainless Steel			Stainless Steel			Stainless Steel			Stainless Steel				
STEM	Stainless Steel			Stainless Steel			Stainless Steel			Stainless Steel			Stainless Steel				
BALL	Stainless Steel			Stainless Steel			Stainless Steel			Stainless Steel			Stainless Steel				
SEAT	Stainless Steel			Stainless Steel			FILLTITE® PTFE			FILLTITE® PTFE			FILLTITE® PTFE				
				SIZE.10 Gear operation type			Full Port			Full Port			Full Port SIZE.4 to 8 Gear operation type				



TYPE	FLOATING BALL					FLOATING BALL					FLOATING BALL					FLOATING BALL					FLOATING BALL				
Ball Valve																									
FIG	10UTDZ3H / G-10UTDZ3H					20UTDZ3H / G-20UTDZ3H					10UTDZ5H / G-10UTDZ5H					20UTDZ5H / G-20UTDZ5H					10UTDZ6H / G-10UTDZ6H				
PRESSURE	10K					20K					10K					20K					10K				
END CONNECTION	JIS B2220					JIS B2220					JIS B2220					JIS B2220					JIS B2220				
DIMENSIONS	inch																								
	mm																								
	1/2	15	108	108	130	140	108	130	108	108	130	140	108	130	108	108	130								
	3/4	20	117	111	130	152	111	130	117	111	130	152	111	130	117	111	130								
	1	25	127	124	160	165	124	160	127	124	160	165	124	160	127	124	160								
	1 1/4	32	140	128	160	178	128	160	140	128	160	178	128	160	140	128	160								
	1 1/2	40	165	134	230	190	139	600	165	134	230	190	139	600	165	134	230								
	2	50	178	148	300	216	148	600	178	148	300	216	148	600	178	148	300								
	2 1/2	65	190	209	600	241	209	1000	190	209	600	241	209	1000	190	209	600								
	3	80	203	219	600	283	219	1000	203	219	600	283	219	1000	203	219	600								
	4	100	229	251	1000	305	286	360	229	251	1000	305	286	360	229	251	1000								
5	125	356	274	310	381	302	360	356	302	360	381	299	500	356	302	360									
6	150	394	335	360	403	360	500	394	335	360	403	360	500	394	335	360									
8	200	457	417	500	502	489	500	457	417	500	502	489	500	457	417	500									
10	250	-	-	-	-	-	-	-	-	-	-	-	-	-	-	-									
BODY	Stainless Steel					Stainless Steel					Stainless Steel					Stainless Steel									
CAP	Stainless Steel					Stainless Steel					Stainless Steel					Stainless Steel									
STEM	Stainless Steel					Stainless Steel					Stainless Steel					Stainless Steel									
BALL	Stainless Steel					Stainless Steel					Stainless Steel+Cr PLATING					Stainless Steel+Cr PLATING									
SEAT	CARBON+Stainless Steel					CARBON+Stainless Steel					Stainless Steel+SFNi					Stainless Steel+SFNi									
	Full Port SIZE.5 to 8 Gear operation type					Full Port SIZE.4 to 8 Gear operation type					Full Port SIZE.5 to 8 Gear operation type					Full Port SIZE.4 to 8 Gear operation type									

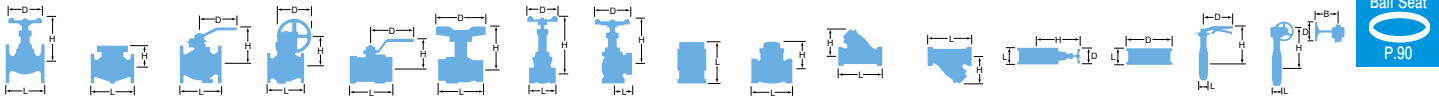
TYPE	FLOATING BALL					FLOATING BALL					FLOATING BALL					FLOATING BALL					FLOATING BALL				
Ball Valve																									
FIG	10UTDZ6HM / G-10UTDZ6HM					20UTDZ6H / G-20UTDZ6H					150UTDZ / G-150UTDZ					150UTDZ1H / G-150UTDZ1H					150UTDZ1HM / G-150UTDZ1HM				
PRESSURE	10K					20K					Class 150					Class 150					Class 150				
END CONNECTION	JIS B2220					JIS B2220					ASME B16.5					ASME B16.5					ASME B16.5				
DIMENSIONS	inch																								
	mm																								
	1/2	15	108	108	130	140	108	130	108	108	130	108	108	130	108	108	130								
	3/4	20	117	111	130	152	111	130	117	111	130	117	111	130	117	111	130								
	1	25	127	124	160	165	124	160	127	124	160	127	124	160	127	124	160								
	1 1/4	32	140	128	160	178	128	160	140	128	160	140	128	160	140	128	160								
	1 1/2	40	165	134	230	190	139	600	165	134	230	165	134	230	165	134	230								
	2	50	178	148	300	216	148	600	178	143	230	178	143	230	178	143	230								
	2 1/2	65	190	209	600	241	209	1000	190	179	400	190	179	400	190	179	400								
	3	80	203	219	600	283	219	1000	203	189	400	203	189	400	203	189	400								
	4	100	229	251	1000	305	286	360	229	224	460	229	251	750	229	251	750								
5	125	356	302	360	381	299	500	356	240	460	356	274	310	356	274	310									
6	150	394	335	360	403	360	500	394	315	1000	394	335	360	394	335	360									
8	200	457	417	500	502	489	500	457	406	1500	457	409	500	457	409	500									
10	250	-	-	-	-	-	-	533	498	500	533	456	500	533	456	500									
BODY	Stainless Steel					Stainless Steel					Stainless Steel					Stainless Steel									
CAP	Stainless Steel					Stainless Steel					Stainless Steel					Stainless Steel									
STEM	Stainless Steel					Stainless Steel					Stainless Steel					Stainless Steel									
BALL	Stainless Steel+SFNi					Stainless Steel+SFNi					Stainless Steel					Stainless Steel									
SEAT	Stainless Steel+SFNi					Stainless Steel+SFNi					HYPATITE® PTFE					FILLTITE® PTFE									
	Full Port SIZE.5 to 8 Gear operation type					Full Port SIZE.4 to 8 Gear operation type					Full Port SIZE.10 Gear operation type					Full Port SIZE.5 to 10 Gear operation type									

Bronze & Brass
 Cast Iron
 Ductile Iron
 Stainless Steel
 Carbon Steel
 Buttery Valve
 Ball Valve
 Ball Valve Seat
 Actuated Valve



TYPE	FLOATING BALL						FLOATING BALL			FLOATING BALL			FLOATING BALL			FLOATING BALL		
Ball Valve																		
FIG	300UTDZ1H / G-300UTDZ1H						300UTDZ1HM / G-300UTDZ1HM			150UTDZ3H / G-150UTDZ3H			150UTDZ3HM / G-150UTDZ3HM			300UTDZ3H / G-300UTDZ3H		
PRESSURE	Class 300						Class 300			Class 150			Class 150			Class 300		
END CONNECTION	ASME B16.5						ASME B16.5 / B16.10			ASME B16.5			ASME B16.5			ASME B16.5		
DIMENSIONS	inch	mm	L	H	D	L	H	D	L	H	D	L	H	D	L	H	D	
	1/2	15	140	108	130	140	108	130	108	108	130	108	108	130	140	108	130	
	3/4	20	152	111	130	152	111	130	117	111	130	117	111	130	152	111	130	
	1	25	165	124	160	165	124	160	127	124	160	127	124	160	165	124	160	
	1 1/4	32	—	—	—	—	—	—	140	128	160	140	128	160	—	—	—	
	1 1/2	40	190	134	230	190	134	230	165	134	230	165	134	230	190	139	600	
	2	50	216	143	230	216	143	230	178	148	300	178	148	300	216	148	600	
	2 1/2	65	241	179	400	241	179	400	190	209	600	190	209	600	241	209	1000	
	3	80	283	189	400	283	189	400	203	219	600	203	219	600	283	219	1000	
	4	100	305	258	310	305	258	310	229	251	1000	229	251	1000	305	286	360	
	5	125	—	—	—	—	—	—	356	274	310	356	274	310	—	—	—	
	6	150	403	332	500	403	332	500	394	335	360	394	335	360	403	360	500	
	8	200	502	417	500	502	417	500	457	417	500	457	417	500	502	489	500	
BODY	Stainless Steel						Stainless Steel			Stainless Steel			Stainless Steel			Stainless Steel		
CAP	Stainless Steel						Stainless Steel			Stainless Steel			Stainless Steel			Stainless Steel		
STEM	Stainless Steel						Stainless Steel			Stainless Steel			Stainless Steel			Stainless Steel		
BALL	Stainless Steel						Stainless Steel			Stainless Steel			Stainless Steel			Stainless Steel		
SEAT	FILLTITE® PTFE						FILLTITE® PTFE			CARBON+Stainless Steel			CARBON+Stainless Steel			CARBON+Stainless Steel		
	Full Port SIZE.4 to 8 Gear operation type						Full Port SIZE.4 to 8 Gear operation type			Full Port SIZE.5 to 8 Gear operation type			Full Port SIZE.5 to 8 Gear operation type			Full Port SIZE.4 to 8 Gear operation type		

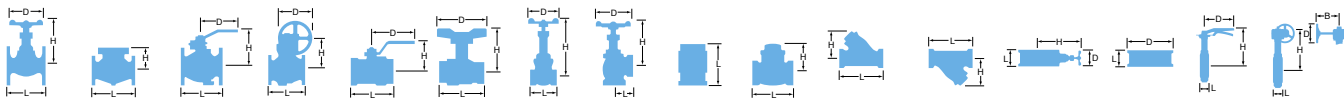
TYPE	FLOATING BALL						FLOATING BALL			FLOATING BALL			FLOATING BALL			FLOATING BALL		
Ball Valve																		
FIG	300UTDZ3HM / G-300UTDZ3HM						150UTDZ5H / G-150UTDZ5H			150UTDZ5HM / G-150UTDZ5HM			300UTDZ5H / G-300UTDZ5H			150UTDZ6H / G-150UTDZ6H		
PRESSURE	Class 300						Class 150			Class 150			Class 300			Class 150		
END CONNECTION	ASME B16.5 / B16.10						ASME B16.5			ASME B16.5			ASME B16.5			ASME B16.5		
DIMENSIONS	inch	mm	L	H	D	L	H	D	L	H	D	L	H	D	L	H	D	
	1/2	15	140	108	130	108	108	130	108	108	130	140	108	130	108	108	130	
	3/4	20	152	111	130	117	111	130	117	111	130	152	111	130	117	111	130	
	1	25	165	124	160	127	124	160	127	124	160	165	124	160	127	124	160	
	1 1/4	32	—	—	—	140	128	160	140	128	160	—	—	—	140	128	160	
	1 1/2	40	190	139	600	165	134	230	165	134	230	190	139	600	165	134	230	
	2	50	216	148	600	178	148	300	178	148	300	216	148	600	178	148	300	
	2 1/2	65	241	209	1000	190	209	600	190	209	600	241	209	1000	190	209	600	
	3	80	283	219	1000	203	219	600	203	219	600	283	219	1000	203	219	600	
	4	100	305	286	360	229	251	1000	229	251	1000	305	286	360	229	251	1000	
	5	125	—	—	—	356	302	360	356	302	360	—	—	—	356	302	360	
	6	150	403	360	500	394	335	360	394	335	360	403	360	500	394	335	360	
	8	200	502	489	500	457	417	500	457	417	500	502	489	500	457	417	500	
BODY	Stainless Steel						Stainless Steel			Stainless Steel			Stainless Steel			Stainless Steel		
CAP	Stainless Steel						Stainless Steel			Stainless Steel			Stainless Steel			Stainless Steel		
STEM	Stainless Steel						Stainless Steel			Stainless Steel			Stainless Steel			Stainless Steel		
BALL	Stainless Steel						Stainless Steel+Cr PLATING			Stainless Steel+Cr PLATING			Stainless Steel+Cr PLATING			Stainless Steel+SFNi		
SEAT	CARBON+Stainless Steel						Stainless Steel+SFNi			Stainless Steel+SFNi			Stainless Steel+SFNi			Stainless Steel+SFNi		
	Full Port SIZE.4 to 8 Gear operation type						Full Port SIZE.5 to 8 Gear operation type			Full Port SIZE.5 to 8 Gear operation type			Full Port SIZE.4 to 8 Gear operation type			Full Port SIZE.5 to 8 Gear operation type		



TYPE	FLOATING BALL					FLOATING BALL			FLOATING BALL			FLOATING BALL			FLOATING BALL		
Ball Valve																	
FIG	150UTD26H / G-150UTD26H					150UTD26HM / G-150UTD26HM			300UTD26H / G-300UTD26H			300UTD26HM / G-300UTD26HM			150UTDZXL / G-150UTDZXL		
PRESSURE	Class 150					Class 150			Class 300			Class 300			Class 150		
END CONNECTION	ASME B16.5					ASME B16.5			ASME B16.5			ASME B16.5			ASME B16.5		
DIMENSIONS	inch	L	H	D	L	H	D	L	H	D	L	H	D	L	H	D	
	mm	L	H	D	L	H	D	L	H	D	L	H	D	L	H	D	
	1/2	15	108	108	130	108	108	130	140	108	130	140	108	130	108	228	130
	3/4	20	117	111	130	117	111	130	152	111	130	152	111	130	117	231	130
	1	25	127	124	160	127	124	160	165	124	160	165	124	160	127	268	160
	1 1/4	32	140	128	160	140	128	160	—	—	—	—	—	—	140	272	160
	1 1/2	40	165	134	230	165	134	230	190	139	600	190	139	600	165	300	230
	2	50	178	148	300	178	148	300	216	148	600	216	148	600	178	309	230
	2 1/2	65	190	209	600	190	209	600	241	209	1000	241	209	1000	190	373	400
	3	80	203	219	600	203	219	600	283	219	1000	283	219	1000	203	383	400
	4	100	229	251	1000	229	251	1000	305	286	360	305	286	360	229	458	750
5	125	356	302	360	356	302	360	—	—	—	—	—	—	356	482	310	
6	150	394	335	360	394	335	360	403	360	500	403	360	500	394	572	360	
8	200	457	417	500	457	417	500	502	489	500	502	489	500	457	685	500	
10	250	—	—	—	—	—	—	—	—	—	—	—	—	533	724	500	
BODY	Stainless Steel					Stainless Steel			Stainless Steel			Stainless Steel			Stainless Steel		
CAP	Stainless Steel					Stainless Steel			Stainless Steel			Stainless Steel			Stainless Steel		
STEM	Stainless Steel					Stainless Steel			Stainless Steel			Stainless Steel			Stainless Steel		
BALL	Stainless Steel+SFNi					Stainless Steel+SFNi			Stainless Steel+SFNi			Stainless Steel+SFNi			Stainless Steel		
SEAT	Stainless Steel+SFNi					Stainless Steel+SFNi			Stainless Steel+SFNi			Stainless Steel+SFNi			HYPATITE® PTFE		
	Full Port SIZE.5 to 8 Gear operation type					Full Port SIZE.5 to 8 Gear operation type			Full Port SIZE.4 to 8 Gear operation type			Full Port SIZE.4 to 8 Gear operation type			Full Port SIZE.5 to 10 Gear operation type		

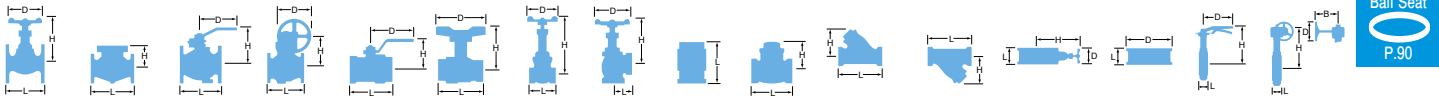
TYPE	FLOATING BALL					FLOATING BALL			FLOATING BALL			FLOATING BALL			FLOATING BALL		
Ball Valve																	
FIG	300UTDZXL / G-300UTDZXL					SCTK			10SCTDZ / G-10SCTDZ			20SCTDZ			150SCTDZ / G-150SCTDZ		
PRESSURE	Class 300					TYPE 600			10K			20K			Class 150		
END CONNECTION	ASME B16.5					BS21 (JIS B0203)			JIS B2220			JIS B2220			ASME B16.5		
DIMENSIONS	inch	L	H	D	L	H	D	L	H	D	L	H	D	L	H	D	
	mm	L	H	D	L	H	D	L	H	D	L	H	D	L	H	D	
	1/4	8	—	—	—	39	31	60	—	—	—	—	—	—	—	—	
	3/8	10	—	—	—	44	36	70	—	—	—	—	—	—	—	—	
	1/2	15	140	228	130	56.5	39	85	108	108	130	140	108	130	108	108	130
	3/4	20	152	231	130	59	43	85	117	111	130	152	111	130	117	111	130
	1	25	165	268	160	71	48	100	127	124	160	165	124	160	127	124	160
	1 1/4	32	—	—	—	78	53	100	—	—	—	—	—	—	—	—	—
	1 1/2	40	190	300	230	83	62	125	165	134	230	190	134	230	165	134	230
	2	50	216	309	230	100	70	125	178	143	230	216	143	230	178	143	230
	2 1/2	65	241	373	400	—	—	—	190	179	400	241	179	400	190	179	400
3	80	283	383	400	—	—	—	203	189	400	283	189	400	203	189	400	
4	100	305	466	310	—	—	—	229	224	460	305	251	750	229	224	460	
5	125	—	—	—	—	—	—	356	240	460	381	267	750	356	240	460	
6	150	403	569	500	—	—	—	394	315	1000	403	315	1000	394	315	1000	
8	200	502	685	500	—	—	—	457	406	1500	502	406	1500	457	406	1500	
10	250	—	—	—	—	—	—	533	448	500	—	—	—	533	448	500	
BODY	Stainless Steel					Cast Steel			Cast Steel			Cast Steel			Cast Steel		
CAP	Stainless Steel					—			Cast Steel			Cast Steel			Cast Steel		
STEM	Stainless Steel					Stainless Steel			Stainless Steel			Stainless Steel			Stainless Steel		
BALL	Stainless Steel					Stainless Steel			Stainless Steel			Stainless Steel			Stainless Steel		
SEAT	HYPATITE® PTFE					G/F PTFE			HYPATITE® PTFE			HYPATITE® PTFE			HYPATITE® PTFE		
	Full Port SIZE.4 to 8 Gear operation type					Reduced Port			Full Port SIZE.10 Gear operation type			Full Port			Full Port SIZE.10 Gear operation type		





Bronze & Brass
 Cast Iron
 Ductile Iron
 Stainless Steel
 Carbon Steel
 Butterfly Valve
 Ball Valve
 Ball Valve Seat
 Actuated Valve







TYPE	FLOATING BALL					FLOATING BALL					FLOATING BALL					FLOATING BALL					FLOATING BALL				
Ball Valve																									
FIG	150SCTDZM					300SCTDZ					300SCTDZM					10SCTDZ1H / G-10SCTDZ1H					20SCTDZ1H / G-20SCTDZ1H				
PRESSURE	Class 150					Class 300					Class 300					10K					20K				
END CONNECTION	ASME B16.5					ASME B16.5					ASME B16.5					JIS B2220					JIS B2220				
DIMENSIONS	inch	mm	L	H	D	L	H	D	L	H	D	L	H	D	L	H	D	L	H	D	L	H	D		
	1/2	15	108	108	130	140	108	130	140	108	130	108	108	130	140	108	130	140	108	130	140	108	130		
	3/4	20	117	111	130	152	111	130	152	111	130	117	111	130	152	111	130	152	111	130	152	111	130		
	1	25	127	124	160	165	124	160	165	124	160	127	124	160	165	124	160	165	124	160	165	124	160		
	1 1/2	40	165	134	230	190	134	230	190	134	230	165	134	230	190	134	230	190	134	230	190	134	230		
	2	50	178	143	230	216	143	230	216	143	230	178	143	230	216	143	230	216	143	230	216	143	230		
	2 1/2	65	190	179	400	241	179	400	241	179	400	190	179	400	241	179	400	241	179	400	241	179	400		
	3	80	203	189	400	283	189	400	283	189	400	203	189	400	283	189	400	283	189	400	283	189	400		
	4	100	229	224	460	305	251	750	305	251	750	229	251	750	305	258	310	305	258	310	305	258	310		
	5	125	356	240	460	—	—	—	—	—	—	356	274	310	381	302	360	381	302	360	381	302	360		
	6	150	394	315	1000	403	315	1000	403	315	1000	394	335	360	403	332	500	403	332	500	403	332	500		
	8	200	457	406	1500	502	406	1500	502	406	1500	457	417	500	502	417	500	502	417	500	502	417	500		
	10	250	—	—	—	—	—	—	—	—	—	533	456	500	—	—	—	—	—	—	—	—	—		
BODY	Cast Steel					Cast Steel					Cast Steel					Cast Steel					Cast Steel				
CAP	Cast Steel					Cast Steel					Cast Steel					Cast Steel					Cast Steel				
STEM	Stainless Steel					Stainless Steel					Stainless Steel					Stainless Steel					Stainless Steel				
BALL	Stainless Steel					Stainless Steel					Stainless Steel					Stainless Steel					—				
DISC	—					—					—					—					Stainless Steel				
SEAT	HYPATITE® PTFE					HYPATITE® PTFE					HYPATITE® PTFE					FILLTITE® PTFE					FILLTITE® PTFE				
	Full Port					Full Port					Full Port					Full Port SIZE.5 to 10 Gear operation type					Full Port SIZE.100 to 200 Gear operation type				

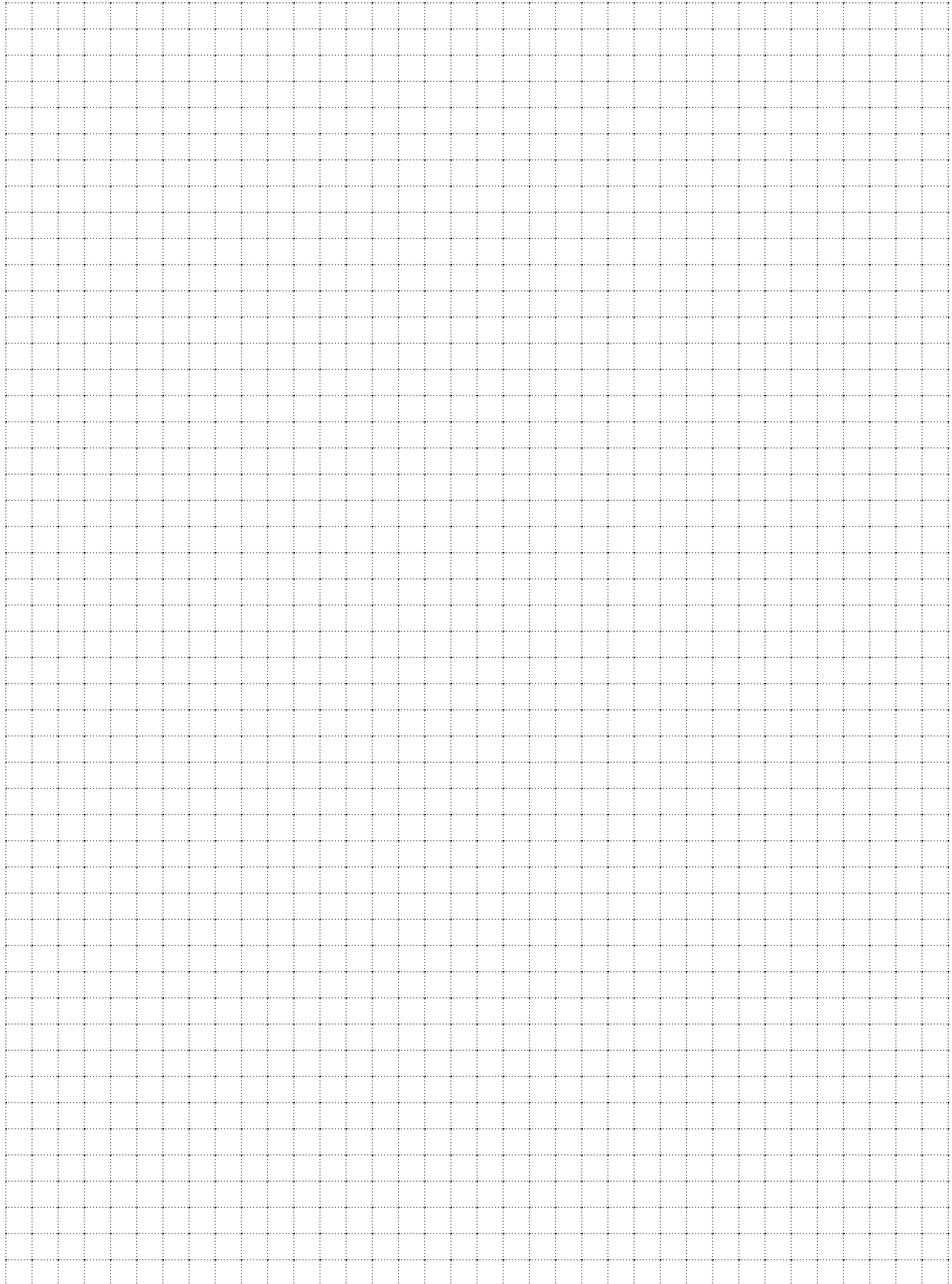
TYPE	FLOATING BALL					FLOATING BALL					FLOATING BALL					FLOATING BALL					FLOATING BALL				
Ball Valve																									
FIG	150SCTDZ1H / G-150SCTDZ1H					300SCTDZ1H / G-300SCTDZ1H					10SCTDZ3H / G-10SCTDZ3H					20SCTDZ3H / G-20SCTDZ3H					150SCTDZ3H / G-150SCTDZ3H				
PRESSURE	Class 150					Class 300					10K					20K					Class 150				
END CONNECTION	ASME B16.5					ASME B16.5					JIS B2220					JIS B2220					ASME B16.5				
DIMENSIONS	inch	mm	L	H	D	L	H	D	L	H	D	L	H	D	L	H	D	L	H	D	L	H	D		
	1/2	15	108	108	130	140	108	130	108	108	130	140	108	130	108	108	130	140	108	130	140	108	130		
	3/4	20	117	111	130	152	111	130	117	111	130	152	111	130	117	111	130	152	111	130	117	111	130		
	1	25	127	124	160	165	124	160	127	124	160	165	124	160	127	124	160	165	124	160	127	124	160		
	1 1/2	40	165	134	230	190	134	230	165	134	230	190	139	600	165	134	230	190	139	600	165	134	230		
	2	50	178	143	230	216	143	230	178	148	300	216	148	600	178	148	300	216	148	600	178	148	300		
	2 1/2	65	190	179	400	241	179	400	190	209	600	241	209	1000	190	209	600	241	209	1000	190	209	600		
	3	80	203	189	400	283	189	400	203	219	600	283	219	1000	203	219	600	283	219	1000	203	219	600		
	4	100	229	251	750	305	258	310	229	251	1000	305	286	360	229	251	1000	305	286	360	229	251	1000		
	5	125	356	274	310	—	—	—	356	274	310	381	302	360	356	274	310	381	302	360	356	274	310		
	6	150	394	335	360	403	332	500	394	335	360	403	360	500	394	335	360	403	360	500	394	335	360		
	8	200	457	409	500	502	417	500	457	417	500	502	489	500	457	417	500	502	489	500	457	417	500		
	10	250	533	456	500	—	—	—	—	—	—	—	—	—	—	—	—	—	—	—	—	—	—		
BODY	Cast Steel					Cast Steel					Cast Steel					Cast Steel					Cast Steel				
CAP	Cast Steel					Cast Steel					Cast Steel					Cast Steel					Cast Steel				
STEM	Stainless Steel					Stainless Steel					Stainless Steel					Stainless Steel					Stainless Steel				
BALL	—					—					—					—					Stainless Steel				
DISC	Stainless Steel					Stainless Steel					Stainless Steel					Stainless Steel					—				
SEAT	FILLTITE® PTFE					FILLTITE® PTFE					CARBON+Stainless Steel					CARBON+Stainless Steel					CARBON+Stainless Steel				
	Full Port SIZE.5 to 10 Gear operation type					Full Port SIZE.4 to 8 Gear operation type					Full Port SIZE.125 to 200 Gear operation type					Full Port SIZE.100 to 200 Gear operation type					Full Port SIZE.5 to 8 Gear operation type				



TYPE	FLOATING BALL					FLOATING BALL			FLOATING BALL			FLOATING BALL			FLOATING BALL		
Ball Valve																	
FIG	300SCTDZ3H / G-300SCTDZ3H					10SCTDZ5H / G-10SCTDZ5H			20SCTDZ5H / G-20SCTDZ5H			150SCTDZ5H / G-150SCTDZ5H			300SCTDZ5H / G-300SCTDZ5H		
PRESSURE	Class 300					10K			20K			Class 150			Class 300		
END CONNECTION	ASME B16.5					JIS B2220			JIS B2220			ASME B16.5			ASME B16.5		
DIMENSIONS	inch	mm	L	H	D	L	H	D	L	H	D	L	H	D	L	H	D
	1/2	15	140	108	130	108	108	130	140	108	130	108	108	130	140	108	130
	3/4	20	152	111	130	117	111	130	152	111	130	117	111	130	152	111	130
	1	25	165	124	160	127	124	160	165	124	160	127	124	160	165	124	160
	1 1/2	40	190	139	600	165	134	230	190	139	600	165	134	230	190	139	600
	2	50	216	148	600	178	148	300	216	148	600	178	148	300	216	148	600
	2 1/2	65	241	209	1000	190	209	600	241	209	1000	190	209	600	241	209	1000
	3	80	283	219	1000	203	219	600	283	219	1000	203	219	600	283	219	1000
	4	100	305	286	360	229	251	1000	305	286	360	229	251	1000	305	286	360
5	125	-	-	-	356	302	360	381	299	500	356	302	360	-	-	-	
6	150	403	360	500	394	335	360	403	360	500	394	335	360	403	360	500	
8	200	502	489	500	457	417	500	502	489	500	457	417	500	502	489	500	
BODY	Cast Steel					Cast Steel			Cast Steel			Cast Steel			Cast Steel		
CAP	Cast Steel					Cast Steel			Cast Steel			Cast Steel			Cast Steel		
STEM	Stainless Steel					Stainless Steel			Stainless Steel			Stainless Steel / A564 TYPE630			Stainless Steel		
BALL	Stainless Steel					Stainless Steel+Cr PLATING			Stainless Steel+Cr PLATING			Stainless Steel+Cr PLATING			Stainless Steel+Cr PLATING		
SEAT	CARBON+Stainless Steel					Stainless Steel+SFNi			Stainless Steel+SFNi			Stainless Steel+SFNi			Stainless Steel+SFNi		
	Full Port SIZE: 4 to 8 Gear operation type					Full Port SIZE: 125 to 200 Gear operation type			Full Port SIZE: 100 to 200 Gear operation type			Full Port SIZE: 5 to 8 Gear operation type			Full Port SIZE: 4 to 8 Gear operation type		





TYPE	FLOATING BALL					FLOATING BALL			FLOATING BALL			FLOATING BALL		
Ball Valve														
FIG	10SCTDZ6H / G-10SCTDZ6H					20SCTDZ6H / G-20SCTDZ6H			150SCTDZ6H / G-150SCTDZ6H			300SCTDZ6H / G-300SCTDZ6H		
PRESSURE	10K					20K			Class 150			Class 300		
END CONNECTION	JIS B2220					JIS B2220			ASME B16.5			ASME B16.5		
DIMENSIONS	inch	mm	L	H	D	L	H	D	L	H	D	L	H	D
	1/2	15	108	108	130	140	108	130	108	108	130	140	108	130
	3/4	20	117	111	130	152	111	130	117	111	130	152	111	130
	1	25	127	124	160	165	124	160	127	124	160	165	124	160
	1 1/2	40	165	134	230	190	139	600	165	134	230	190	139	600
	2	50	178	148	300	216	148	600	178	148	300	216	148	600
	2 1/2	65	190	209	600	241	209	1000	190	209	600	241	209	1000
	3	80	203	219	600	283	219	1000	203	219	600	283	219	1000
	4	100	229	251	1000	305	286	360	229	251	1000	305	286	360
5	125	356	302	360	381	299	500	356	302	360	-	-	-	
6	150	394	335	360	403	360	500	394	335	360	403	360	500	
8	200	457	417	500	502	489	500	457	417	500	502	489	500	
BODY	Cast Steel					Cast Steel			Cast Steel			Cast Steel		
CAP	Cast Steel					Cast Steel			Cast Steel			Cast Steel		
STEM	Stainless Steel					Stainless Steel			Stainless Steel			Stainless Steel		
BALL	Stainless Steel+SFNi					Stainless Steel+SFNi			Stainless Steel+SFNi			Stainless Steel+SFNi		
SEAT	Stainless Steel+SFNi					Stainless Steel+SFNi			Stainless Steel+SFNi			Stainless Steel+SFNi		
	Full Port SIZE: 125 to 200 Gear operation type					Full Port SIZE: 100 to 200 Gear operation type			Full Port SIZE: 5 to 8 Gear operation type			Full Port SIZE: 4 to 8 Gear operation type		






Bronze & Brass
 Cast Iron
 Ductile Iron
 Stainless Steel
 Carbon Steel
 Butterfly Valve
 Ball Valve
 Ball Valve Seal
 Actuated Valve



BALL VALVE SEAT

Ball Valve Seat

TYPE	PTFE	HYPATITE® PTFE	C/F PTFE	FILLTITE® (1H)
BALL VALVE SEAT	Polytetrafluoroethylene resin 	HYPATITE® Polytetrafluoroethylene resin 	Carbon fiber filled Polytetrafluoroethylene resin 	Polytetrafluoroethylene resin with carbon based special filler 
	<ul style="list-style-type: none"> PTFE seats possess high chemical resistance and excellent sealing performance 	<ul style="list-style-type: none"> HYPATITE® seats are made of modified PTFE. HYPATITE® seats has an excellent resistance to creep or compression and abrasion service, featuring of high elasticity and resilience. HYPATITE® seats also have good chemical resistance, so they can be used for a widerange of chemicals as PTFE. * HYPATITE® PTFE is a registered trademark of KITZ Corporation. 	<ul style="list-style-type: none"> This ball seat is made of PTFE reinforced with carbon. The seat has high mechanical strength and abrasion resistance. 	<ul style="list-style-type: none"> FILLTITE® seats can be used at a temperature as high as 300°C, the highest service temperature among PTFE based ball seats. <p>The ball seats are used in Class JIS 10K · 20K / ASME Class 150 · 300 ductile iron, stainless steel and carbon steel floating ball valves.</p>
	<p>The ball seats are used in bronze, brass and cast iron floating ball valves</p> <p>Maximum Service Temperature: 200°C</p>	<p>The ball seats are used in Class JIS 10K · 20K / ASME Class 150 · 300 ductile iron, stainless steel and carbon steel floating ball valves.</p> <p>Maximum Service Temperature: 270°C</p>	<p>The ball seats are used in Class JIS 10K · 20K / ASME Class 150 · 300 ductile iron, stainless steel and carbon steel floating ball valves.</p> <p>Maximum Service Temperature: 270°C</p>	<p>The ball seats are used in Class JIS 10K · 20K / ASME Class 150 · 300 ductile iron, stainless steel and carbon steel floating ball valves.</p> <p>Maximum allowable seat leakage</p> <ul style="list-style-type: none"> For oil-free valves: ANSI /FCI 70-2 Class VI. (Test media, Air) <p>Maximum Service Temperature: 300°C</p>

TYPE	CARBOTITE (3H)	Metal seat (5H)	Metal seat (6H)	SWELLESS® seat	PEEK seat
BALL VALVE SEAT	Hard carbon 	Hard faced metal seat 	Hard faced metal seat 		Polyetheretherketone resin 
	<ul style="list-style-type: none"> CARBOTITE seats are made of hard carbon with excellent heat resistance. Maximum service temperature is 500°C. The leakage may increase when valves are exposed to an oxidized service at a higher temperature than 450°C for extended periods 	<ul style="list-style-type: none"> The surface of the 316 stainless steel seats is hard faced by thermal-spraying with nickel and chrome alloys for 300°C high temperature service. The seat has high abrasion resistance so that it can handle fluids including foreign particles. 	<ul style="list-style-type: none"> The ball and ball seat surfaces are hard faced by thermal-spraying with nickel and chrome alloys, which enables valves to be used at a temperature of 500°C. Valves with the 6H seats are excellent in high abrasion and high temperature services so that they can be used for fluids including foreign particles and application of heated steam. 	<ul style="list-style-type: none"> SWELLESS® seats have excellent resistance to the permeation of monomer, such as Styrene or Butadiene, into the molecular structure of the ball seat materials, which is known as a "swelling" problem. Excellent sealing performance, operability and chemical resistance have been achieved by using fluoride resin as the base for the ball seat. 	<ul style="list-style-type: none"> PEEK seats have high mechanical strength at a wide range of temperatures. The seat has excellent heat and chemical resistance.
	<p>The ball seats are used in Class JIS 10K · 20K / ASME Class 150 · 300 stainless steel and carbon steel floating ball valves.</p> <p>Maximum allowable seat leakage ANSI /FCI 70-2 Class VI. (Test media, Air)</p> <p>Maximum Service Temperature: 500°C</p>	<p>The ball seats are used in Class JIS 10K · 20K / ASME Class 150 · 300 stainless steel and carbon steel floating ball valves.</p> <p>Maximum allowable seat leakage ANSI /FCI 70-2 Class VI. (Test media, Air) * For oil-free valves: 21.75ml/min. x port diameter (inch) x differential pressure (MPa)</p> <p>Maximum Service Temperature: 300°C</p>	<p>The ball seats are used in Class JIS 10K · 20K / ASME Class 150 · 300 stainless steel and carbon steel floating ball valves.</p> <p>Maximum allowable seat leakage ANSI /FCI 70-2 Class VI. (Test media, Air) * For oil-free valves: 21.75ml/min. x port diameter (inch) x differential pressure (MPa)</p> <p>Maximum Service Temperature: 500°C</p>	<p>The ball seats are used in Class JIS 10K · 20K / ASME Class 150 · 300 stainless steel and carbon steel floating ball valves.</p> <p>Maximum Service Temperature: 260°C</p>	<p>The ball seats are used in Class ASME Class 150 · 300 stainless steel and carbon steel floating and trunnion mounted ball valves.</p> <p>Maximum Service Temperature: 270°C</p>

ACTUATED VALVE

KITZ 10K Compact Ball Valves

Valve Design Features

- Convenient size range from 1/4^B through 2^B.
- Integral actuator mounting pads, which enable easy mounting or dismounting of actuators for speedy maintenance.
- Tight contact between PTFE ball seats and high-precision-machined balls for leakage-free service.
- Stems, made of high-strength brass, are used for a long service life.
- Choice of materials: Stainless steel for corrosion-resistant service, or brass and bronze for general W.O.G. service.

Valve Design Specifications

Threaded ends:	JIS B 0203
Union ends:	JIS B 2301
Maximum service pressure:	1.0 MPa
	TKE, TKVE & TKSE for 3/4 ^B and larger, 5UTWE: 0.5 MPa

Ball Valve Design and Applications

KITZ Fig.	JIS Material	Port	Bore*	Neck	End connection	Applications	Electric Actuator	Pneumatic Actuator
TE	CAC406	2-way	S.B.	Short	Threaded	On-off control of water, oil, and gas.	EA EAB EAL EALB ED** EAE***	Type C & CS (FBS)
TFE	C3771BE or CAC406		F.B.			Instantaneous change of line fluid.		
TLE	CAC406	Horizontal 3-way	S.B.	Long	Insulation for thermal isolation.			
TNE			Short	Instantaneous change of line fluid.				
TUE	CAC406	2-way	R.B.	Short	Male and female threaded with a union ring	Easy installation.	EAE***	Type C & CS
TLUE					Long	TUE with insulation for thermal isolation.		
TKE	Chrome plating C3771BE	Vertical 3-way	R.B.	Short	Threaded	On-off control of water, oil, and gas. M5 tapped for panel mounting.	EC	
TKVE						Instantaneous change of line fluid. (Free from concern of fluid mixing.)	ECS	
TKSE						2-way	On-off control of water, oil, and gas. M5 tapped for panel mounting.	
TNVE	CAC406	Vertical 3-way	S.B.	Short	Threaded	Instantaneous change of line fluid. (Free from concern of fluid mixing.)	EAH EAHB	
UTE	SCS14A	2-way	R.B.			TE made of stainless steel.	EA EAB EAL EALB ED** EAE***	
UTFE			F.B.	TEE made of stainless steel.				
UTNE		Horizontal 3-way	S.B.	TNE made of stainless steel.				
UTGE		2-way	R.B.	TGE made of stainless steel.				
5/10UTWE	SCS13A	2-way	F.B.		Wafer	Full bore wafer design. Easy maintenance.		
UTVE	SCS14A	Vertical 3-way	R.B.		Threaded	Integrally molded body. Instantaneous change of fluid. (Free from concern of fluid mixing.)	EAH EAHB	

* Bore design: F.B.=Full bore, S.B.=Standard bore, R.B.=Reduced bore to API 608.

** ED Series are available only for TE, TNE, UTE, UTFE, UTGE and 5/10UTWE ball valves.

*** EAE Series are available only for TE, TNE, TUE, TKSE and UTE ball valves.

Applications

Automated on-off or three-way flow control in HVAC service handling water, oil, gas, and air (by brass and bronze valves) or in light-load industrial processes for pharmaceutical, fine chemical, petrochemical, food, beverage, textile, and other general industries.

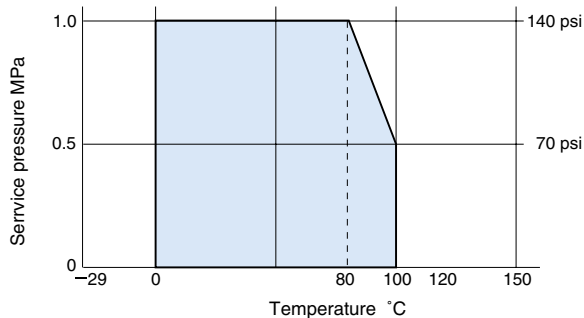
Precautions

- ① No application to fluids including powders, dirt, or sands.
- ②
 - High viscosity fluid, steam, or vacuum
 - Operational frequency higher than 10 times an hour
 - Velocity of 3 m/s or higher
 - Service with concern of an extraordinary pressure rise of line fluid or a variation of fluid temperature higher than 80°C.
 - For voltages other than the KITZ standard specification, contact KITZ or its local distributors for technical advice on application to the following:

PTFE Seat Pressure-temperature Ratings

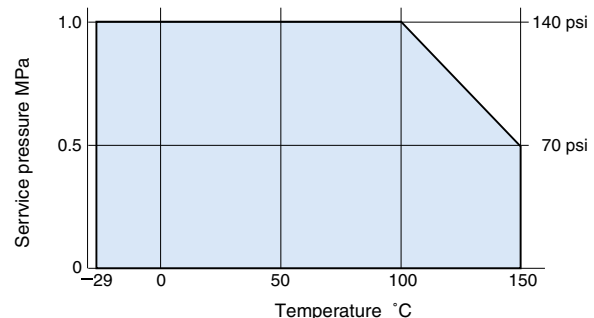
Valve: TE·TFE·TLE·TNE·TUE·TLUE UTE·UTFE·UTNE·5/10UTWE

- Fluid: water, oil, or gas (unfrozen)
- Ball seat: PTFE (Standard)
- O-ring: FKM (Standard)



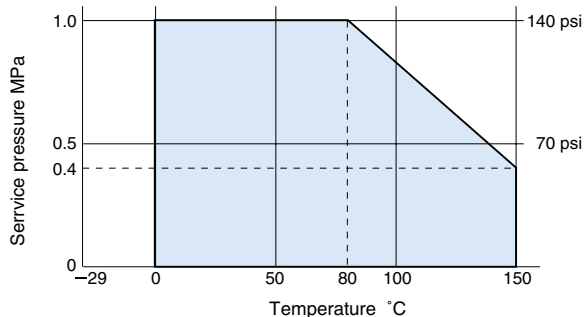
Valve: UTGE

- Fluid: water, oil, or gas (unfrozen)
- Ball seat: reinforced PTFE
- Gland packing: Flexible graphite + PTFE braided packing



Valve: TE·TFE·TLE·TNE·TUE·TLUE UTE·UTFE·UTNE·5/10UTWE

- Fluid: water, oil, or gas (unfrozen) or saturated steam
- Ball seat: reinforced PTFE (Option*)
- O-ring: FKM (Option*)



* Specify these materials in your order for the P-T ratings covered by the graph shown above, except for 1½^B and 2^B. Standard materials are only available for these sizes.

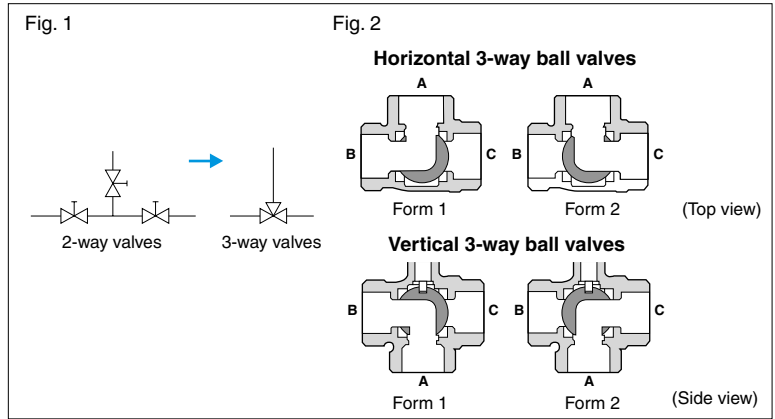
- Note:**
- Please refer to our website (www.kitz.co.jp) or contact KITZ for PTFE pressure-temperature ratings of TKE, TKVE and TKSE.
 - Serviceable ambient temperature depends on the design of actuators. Refer to the information given for each of actuators introduced in this catalog.

Actuated Valve

KITZ Three-way Compact Ball Valves: Change in Flow Directional Form

KITZ horizontal three-way ball valves are used primarily for a quick change in the flow direction. Furthermore, three-way ball valves can be used for simplification of piping systems, as shown in Fig. 1.

KITZ Figs. TNE, TNVE, TKVE, UTNE, and UTVE three-way ball valves are provided with an L-port and double face seating design for achieving a change in the flow direction between Forms 1 and 2. It should be noted if the line pressure of the closed bore is higher than the open bore, slight fluid leakage may occur from the closed bore. (Fig. 2)

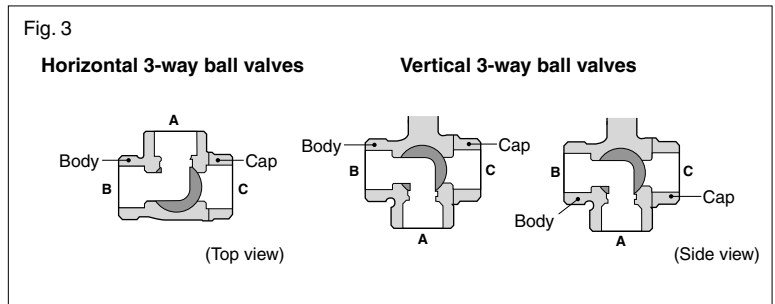


KITZ 3-way Compact Ball Valves: Flow Directional Form

Shipment shall be made with the flow directional form fixed as illustrated here. (Fig. 3)

Location of cord connectors (top view):

- Horizontal 3-way: Size 1 & 1.5: Right hand side
- Size 2: Diagonally forward right
- Vertical 3-way: Size 1: Right hand side
- Size 2: Diagonally forward left

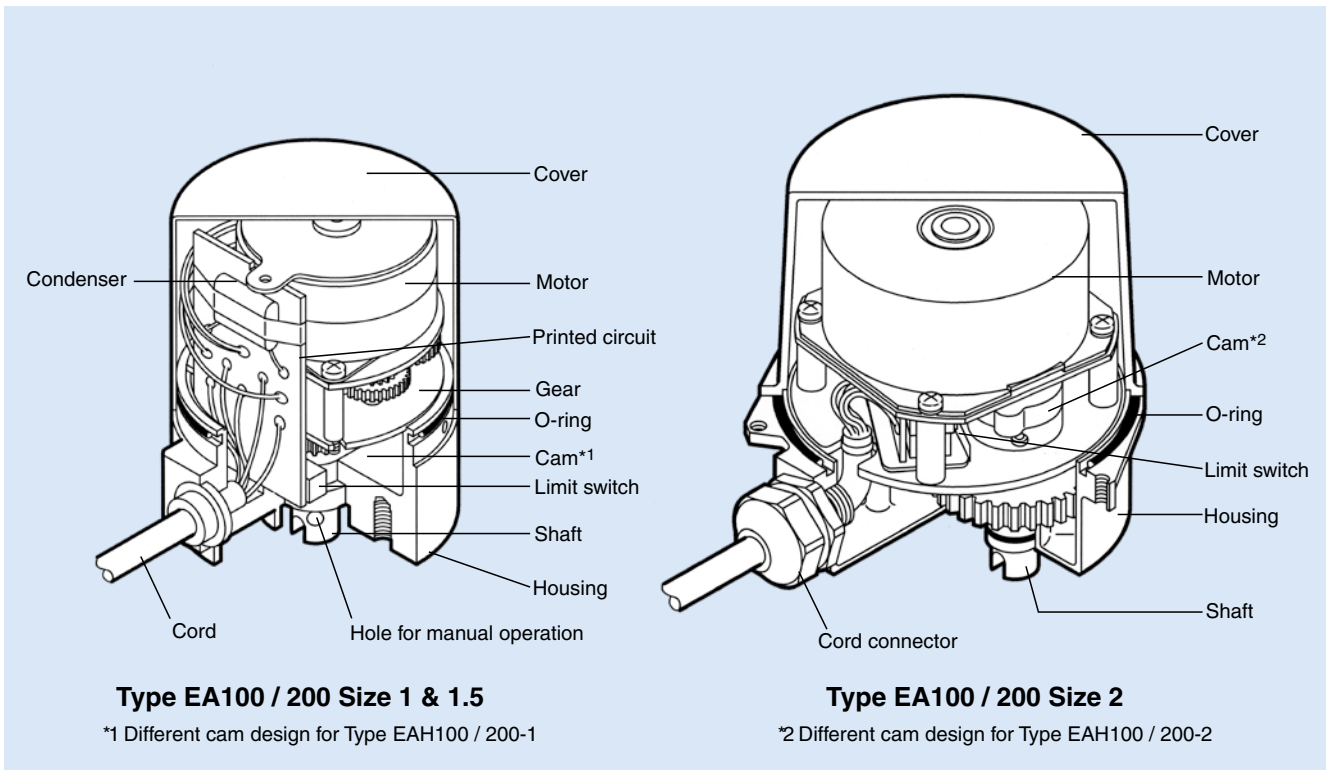


KITZ KELMO® Electric Actuators: EA and ED Series

General design features

- Compact size and light weight with die-cast aluminum housing and powerful miniature motor for economy and handling ease.
- Simple mechanism with minimized number of component parts for high durability and trouble-free service.
- Free from concerns common to conventional solenoid valves, such as water hammer, pressure loss, malfunction caused by jammed valve interior, and restricted flow direction.
- All-weather-type design for outdoor service.
- Availability of manual operation in the case of electric failure.
- Versatile applications by means of optional built-in relay circuit for parallel drive, terminal boxes, and 180° rotary mechanism for three-way flow direction.
- Safety provision to protect the motor from overheating damage caused by accidental overload.
- Factory-made actuator-to-valve assembly for off-the-shelf supply.

KITZ KELMO® Electric Actuators



Compact KELMO® actuators: power sources and functional features

Type of actuator		* Power source	Functional features
EA Series	EA100 / EA200	100 V AC 200 V AC (50 Hz / 60 Hz)	90° bi-directional rotation
	EAB100 / EAB200		90° bi-directional rotation / Terminal box
	EAL100 / EAL200		90° bi-directional rotation / Built-in relay
	EALB100 / EALB200		90° bi-directional rotation / Built-in relay / Terminal box
	EAH100 / EAH200		180° bi-directional rotation
	EAHB100 / EAHB200		180° bi-directional rotation / Terminal box
	EAE100 / EAE200	100 V / 200 V AC (50 Hz / 60 Hz)	90° bi-directional rotation / Spring-return
ED Series	ED12 / ED24	12 V / 24 V DC	90° bi-directional rotation / Parallel drive

* Optional Specification (EA Series)

110 V AC (50/60 HZ)

115 V AC* (50/60 HZ)

120 V AC (50/60 HZ)

230 V AC* (50/60 HZ)

240 V AC (50/60 HZ)

* EA100/200-1 only

Actuated Valve

Type EA Electric Actuators / 10K Bronze or Stainless Steel Ball Valves

■ 90° bi-directional rotation

100 V / 200 V AC 50 Hz / 60 Hz

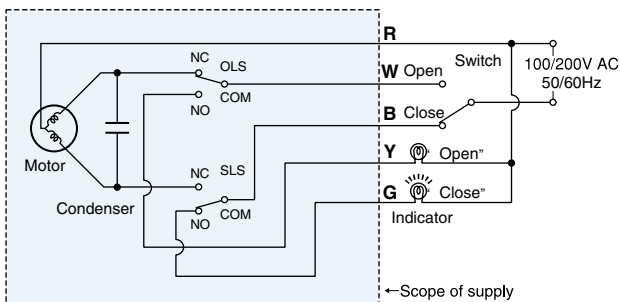
Type EA actuator design specifications

Specification \ Type	EA100-1	EA200-1	EA100-1.5	EA200-1.5	EA100-2	EA200-2
Power source 50 Hz / 60 Hz	100 V AC	200 V AC	100 V AC	200 V AC	100 V AC	200 V AC
Rated current	90 mA	50 mA	90 mA	50 mA	100 mA	50 mA
Max. power consumption	9 W	10 W	9 W	10 W	10 W	
Valve closing time 90°	50 Hz	Approx. 6 sec		Approx. 12 sec		Approx. 15 sec
	60 Hz	Approx. 5 sec		Approx. 10 sec		Approx. 13 sec
Max. output torque	1.9 N·m		3.9 N·m		9.8 N·m	
Rated time	Continuous					
Insulation class	JIS Class E					
Sensitive switch contact capacity	125 V AC / 2 A (Resistance load) 250 V AC / 0.6 A (Resistance load)				125 V AC / 2 A (Resistance load) 250 V AC / 2 A (Resistance load)	
Position limit switch	1 unit each for opening / closing (Using the same power source as that of the actuator)					
Insulation strength	1500 V AC (1 min. interval)					
Insulation resistance	Minimum 10 MΩ (500 V DC)					
Standard protection	All weather type (for outdoor use, avoid sunlight)					
Ambient temperature	−20°C to +50°C					
Mounting position	Vertical to horizontal					
Wiring	Vinyl cabtyre cord with 5 cores, 700 mm in length					
	0.3 mm ²				0.5 mm ²	
Lubrication	Grease					
Overload protection	Impedance protection					
Coating color	Housing: black Cover: light blue					

Note: Contact KITZ for technical advice when the service conditions differ from the above.

Type EA actuator circuit diagrams (with the valve fully closed)

EA100 / 200 Size 1 to 2



Note: For all sizes of Type EAB 100 / 200, the terminals are numbered 1, 2, 3, 4 and 5 in place of R, W, B, Y, and G respectively.

- Wire color: **R** red **W** white **B** black **Y** yellow **G** green
- Actuator rotates:
 - R-W:** counter-clockwise to fully open the valve
 - R-B:** clockwise to fully close the valve
- Limit switches activate:
 - OLS:** on fully opening the valve (R-W: off W-Y: on)
 - SLS:** on fully closing the valve (R-B: off B-G: on)

- Note:**
- When two or more actuators are operated by a single switch, ensure to prevent unintended current flows by using relay contacts.
 - Auxiliary devices, such as lamps or relays, where minute current is used, may cause failure in the contacts of limit switches. Consult KITZ for such applications.

Type ED Electric Actuators / Class 10K Bronze or Stainless Steel Ball Valves

■ DC 12V or 24V for handy, on-the-spot automated valve operation

12 V / 24 V DC

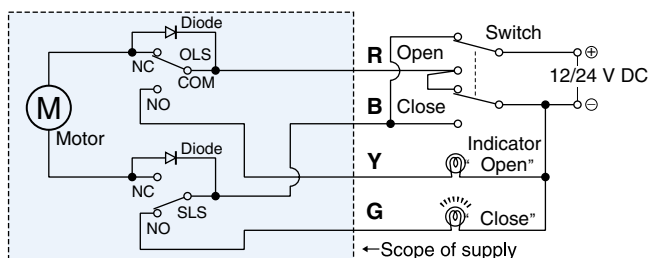
Type ED actuator design specifications

Specification \ Type	ED12-1	ED24-1	ED12-2	ED24-2
Power source 50Hz / 60Hz	12 V DC	24 V DC	12 V DC	24 V DC
Rated current	360 mA	140 mA	520 mA	260 mA
Max. power consumption	5 W	4 W	9 W	10 W
Valve closing time 90° 50 Hz	Approx. 5 sec			
Max. output torque	1.4 N·m		7.3 N·m	
Rated time	5 min			
Insulation class	JIS Class E			
Position limit switch	1 unit each for opening / closing (Using the same power source as that of the actuator)			
Insulation strength	250 V AC (1 min. interval)		500 V AC (1 min. interval)	
Insulation resistance	Minimum 10 MΩ (500 V DC)			
Standard protection	All weather type (for outdoor use)			
Ambient temperature	-20°C to +50°C			
Mounting position	Vertical to horizontal			
Wiring	Vinyl cabtyre cord with 4 cores		UL approved noninflammable cord with 4 cores	
	0.3 mm ²		0.5 mm ²	
Lubrication	Grease			
Overload protection	Impedance protection		Thermal protection	
Coating color	Housing: black		Cover: light blue	

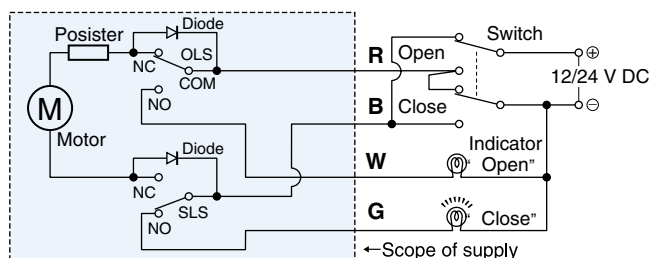
Note: Type ED12-2 and ED24-2 are optionally available for mobile application.
Don't spray high pressure water directly to Type ED actuator during car wash.

Type ED actuator circuit diagrams (with the valve fully closed)

ED 12 / 24 Size 1



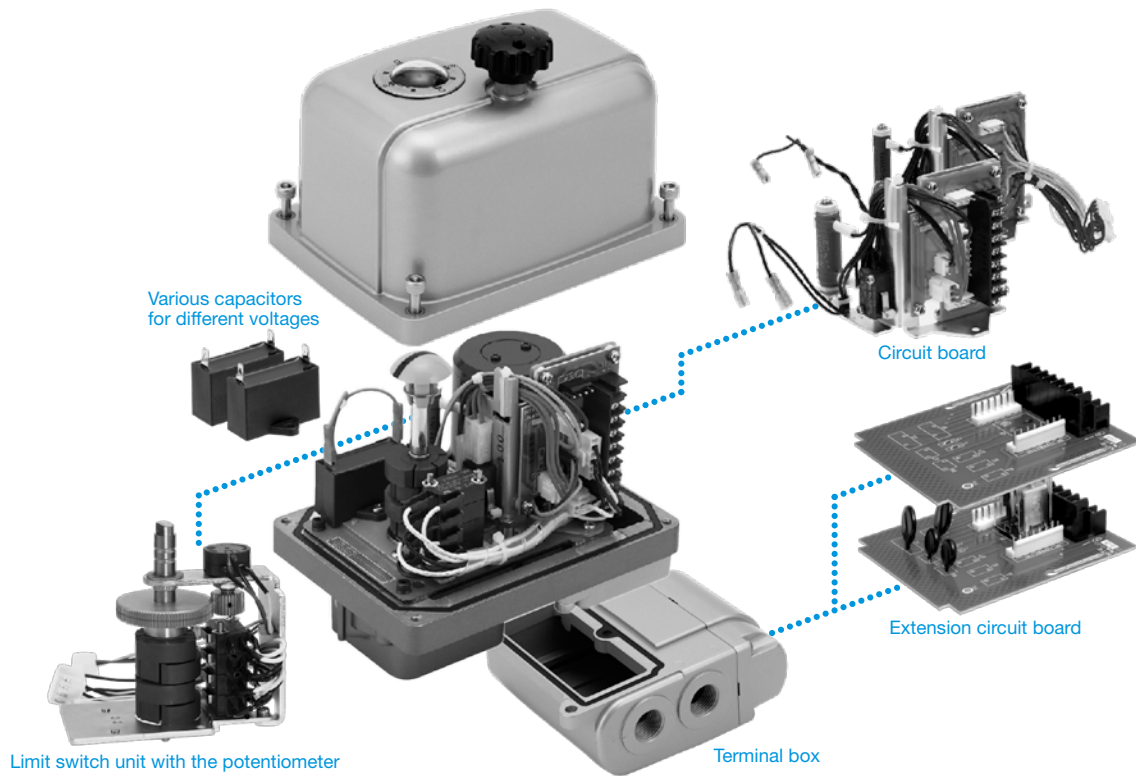
ED 12 / 24 Size 2



- Wire color: **R** red **W** white **B** black **Y** yellow **G** green
- Actuator rotates:
 - R**⊕ - **B**⊖: Counter-clockwise to fully open the valve
 - R**⊖ - **B**⊕: Clockwise to fully close the valve
- Limit switches activate:
 - OLS: on fully opening the valve (R-B: off R-Y(W): on)
 - SLS: on fully closing the valve (R-B: off B-G: on)

Actuated Valve

The adoption of common parts and part modularization have enabled flexible modification, which will widen the applications of the actuator.



Optional specification

Power supply

EXH EXS

AC110 V 50/60 Hz

AC115 V 50/60 Hz

AC120 V 60 Hz

AC220 V 50/60 Hz

AC230 V 50/60 Hz

AC240 V 50 Hz

AC115 V 50 Hz, AC120 V 60 Hz, AC230 V 60 Hz, AC240 V
Allowable fluctuation of supply voltage is limited within between minus 10% and plus 5% for 50 Hz.

Relays

EXH EXS

Relays (on/off by a-contact) can be provided in the actuator by using extension circuit boards

Limit switch specification

EXH EXS

Contact for Micro load (Minute electrical current)
Two standard limit switches can be replaced by optional limit switches for micro load (minute electrical current)

Potentiometer output

EXH EXS

135 Ω (Coil type)

500 Ω (Coil type)

The valve opening degree is indicated by resistance value.

Auxiliary limit switch specification

EXH EXS

Two more additional limit switches can be added.

Switches for micro load application are also available.

Including four standard limit switches, total six switches can be used. (In case the potentiometer is used, four limit switches in total can be used at maximum.)

Terminal box

EXH

G1/2 two conduit ports

G3/4 one conduit port

NPT1/2 two conduit ports

NPT3/4 one conduit port

M20 one conduit port

Terminal box with two G1/2 conduit ports is equipped as standard for EXS type.

For EXH type, the use of the terminal box will enable the actuator to connect cables without removing the cover and to extend the actuator functions by using optional circuit boards.

Conduit port

EXH EXS

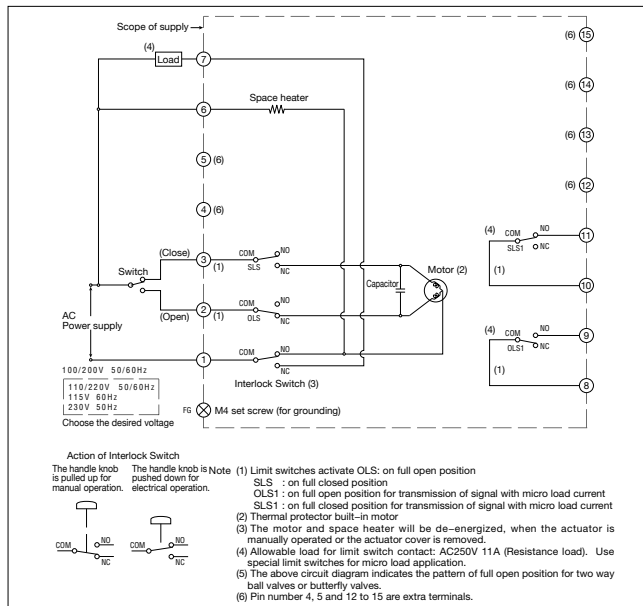
G3/4, NPT1/2, NPT3/4, M20

Specification

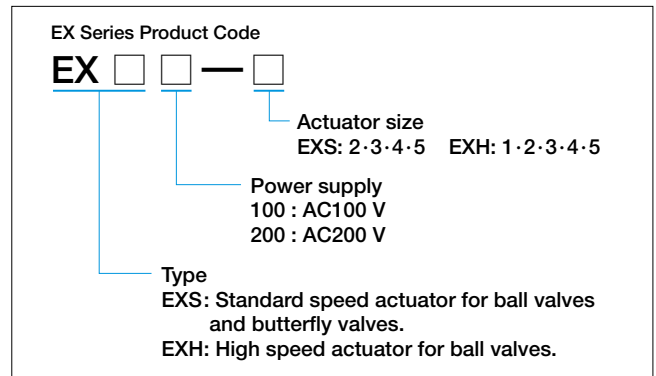
High-speed type For ball valve	EXH100/200-1	EXH100/200-2	EXH100/200-3	EXH100/200-4	EXH100/200-5
Standard-speed type For butterfly valve and ball valve	EXS100/200-2	EXS100/200-3	EXS100/200-4	EXS100/200-5	EXS100/200-5
Power Supply	100/200 V AC ±10% 50/60 Hz				
Output Torque (Nm)	9.8	49	196	588	1000
Rated Current (50/60Hz) (A) *1	100 V AC	0.65	1.2	2.8	2.8
	200 V AC	0.35	0.35	0.6	1.5
Motor Type	Reversible				
Motor Output (W) (Rating)	13/16	13/16	26/31	72/85	72/85
Rotating Direction *2	Tuning clockwise to close and counterclockwise to open valves				
Duty Factor [%ED]	30	30	30	30	30
Valve Closing Time [SEC] *3	EXH 50 Hz	9	14	21	28
	EXH 60 Hz	8	12	17	23
	EXS 50 Hz	—	25	35	49
	EXS 60 Hz	—	21	30	41
Space Heater Volume [W]	100 V AC	15	15	15	15
	200 V AC	15	15	15	15
Position Limit Switch *4	Two switches with voltage and two without voltage supplied				
Switch Contact Voltage	250 V AC 2 A least resistance load				
Insulation Class	JIS Class E, Strength: 1500 V AC 1min. or 1800 V 1sec., Resistance: 100 minimum at 500 V DC				
Overload Protection	Thermal protection				
Service Environment	Indoor / Outdoor (Submergence and direct sunlight must be avoided.)				
Water, Dust — Proof	Equivalent to IP-67				
Ambient Temperature	-10°C to +50°C				
Conduit Port	EXH	One G1/2			
	EXS	Two G1/2			
Mounting Position	From Vertical position to Horizontal position (No downward position)				
Manual Operation	Pull up the manual override handle knob for manual operation, which will activate the built-in interlock switch to cut off power supply. For the restoration of electrical operation, push down the handle knob				
Mechanical Stopper	EXH	Mechanical stoppers are equipped in open and closed position. The stoppers are adjustable by 7 degrees in the both positions			
	EXS	Mechanical stoppers, which can be adjusted in the closed position, are equipped in open and closed position			
Position Indicator	Position indicator, covered by transparent cover, is equipped on the top of the actuator cover				
Mounting Flange	In accordance with ISO5211				

*1 As the actuator is subjected to approx. tenfold rated current at startup, the contacts of electrical devices connected to the actuator must have enough capacity to handle this large electrical current.
 *2 Refer to "Operation manual" for 3 way valves.
 *3 Valve closing time is calculated based on an unloaded condition without the valve being mounted. The closing time will be 10% slower, when the valve is mounted.
 *4 In case load current is 50 mA or smaller, use limit switches for micro load (minute current).

Circuit Diagram



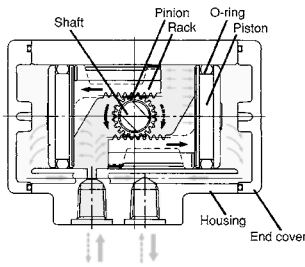
Product Code



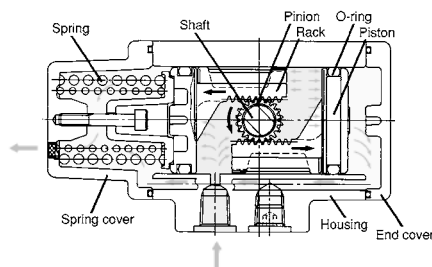
Actuated Valve

KITZ C-CS Series Pneumatic Actuators

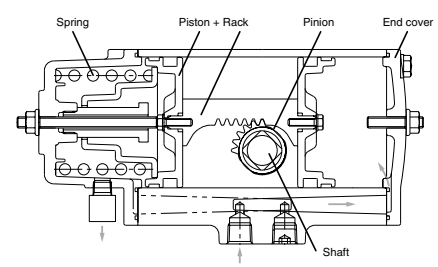
Type C (Double action)



Type CS (Spring return)



Type FBS (Spring return)



Actuator design Specifications

Specification	Type	C-1	C-2	CS-1	CS-2	FBS-1
Operating media		Instrumentation air				
Standard operating pressure		0.4 MPa				
Operating pressure range		0.4 to 0.7 MPa				
Output torque* ¹		3.9 N·m	8.5 N·m	1.3 N·m	3.1 N·m	7.6 N·m
Housing shell test pressure		0.97 MPa				
Angle of revolution		90° (+1 to +5°)				90° ± 7°
Cylinder volume (Litter)		0.073	0.160	0.033	0.071	0.15
Operation time		Max. 1 sec.* ⁴				
Service temperature range* ²		-20°C to +60°C -4°F to +140°F				-20°C to +80°C -4°F to +176°F
Ambient condition* ³		Indoor				

Notes:

*1 At supply pressure 0.4 MPa

*2 Free from freezing of supply air

*3 For outdoor service, consult a KITZ engineer

*4 On a condition of KITZ standard air equipments and no load on

Design Features of KITZ C-CS / FBS Series Actuators

■ Light weight and compact size

Die-cast aluminum body and double-piston mechanism make the actuator lightweight and compact.

■ Simple mechanism

This actuator consists of a minimum number of parts. This enables the actuator to have a longer service life and lowers the possibility of malfunction.

■ Special solenoid valve

A direct-mount-type special solenoid valve used exclusively for the KITZ C type actuator is available.

■ High-efficiency quarter-turn actuator

The double-piston-type rack and pinion mechanism provides high-efficiency quarter-turn rotation.

■ Direct mount type

The actuator is directly mounted on a valve with only two bolts.

The FBS-type actuator should be chosen for larger-sized valves.

Standard guide actuator selection

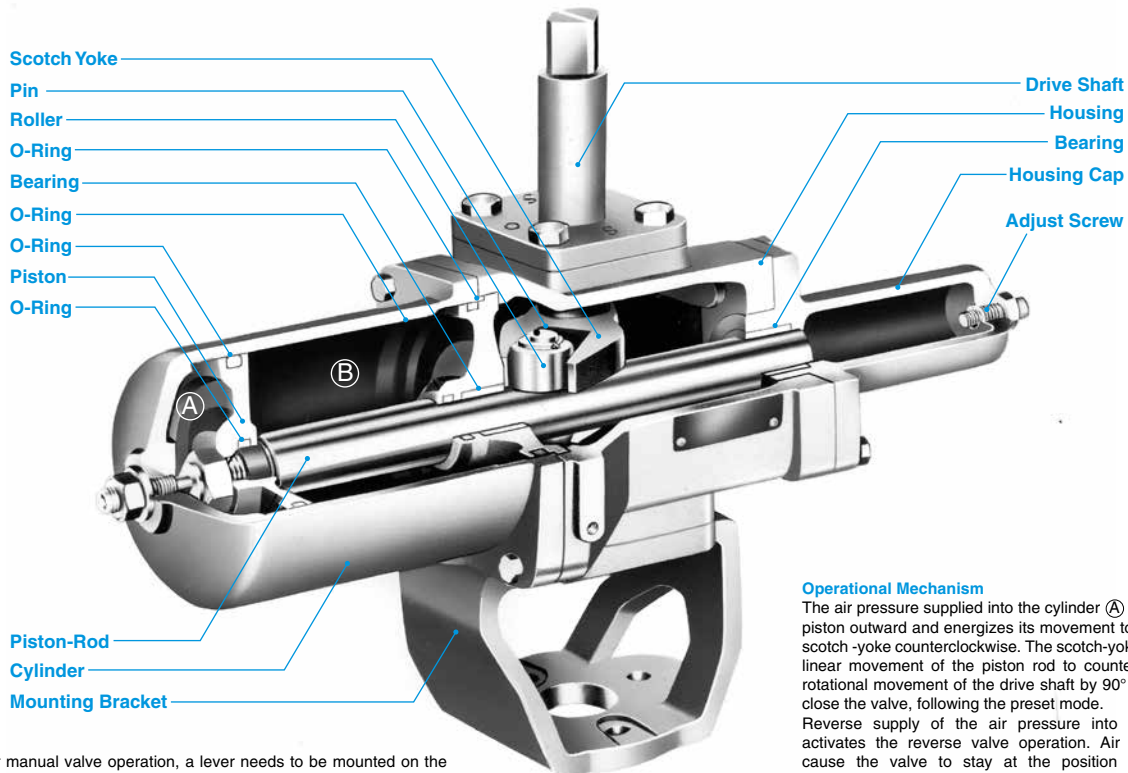
Fig	Size	1/4	3/8	1/2	3/4	1	1 1/4	1 1/2	2
TE		C-1				C-2			
		CS-1	CS-2			(FBS-1)			
TFE		C-1			C-2				
		CS-2	(FBS-1)						
TLE		C-1			C-2				
		CS-2			(FBS-1)				
TNE		C-1				C-2			
		CS-1	CS-2			(FBS-1)			
TUE		C-1							
		CS-2							
UTE		C-1				C-2			
		CS-1	CS-2			(FBS-1)			
UTFE		C-1			C-2				
		CS-2	(FBS-1)						
UTGE		C-1			C-2				
		CS-2	(FBS-1)						
5/10UTWE		C-1			C-2				
		CS-2	(FBS-1)						
UTNE		C-1				C-2			
		CS-1	CS-2			(FBS-1)			

For the size ranges not covered by KITZ C Series actuators, more powerful KITZ Type FBS-1 actuators are recommended.

Features of KITZ B Series Pneumatic Actuators

Type B (Double-Action)

Internationally patented



Note: For manual valve operation, a lever needs to be mounted on the top end of the drive shaft of Type B-1 through B-4 actuators. Separate manual operators are available for Type B-5 and B-6 actuators.

Operational Mechanism

The air pressure supplied into the cylinder (A) pushes the piston outward and energizes its movement to rotate the scotch-yoke counterclockwise. The scotch-yoke converts linear movement of the piston rod to counterclockwise rotational movement of the drive shaft by 90° to open or close the valve, following the preset mode.

Reverse supply of the air pressure into cylinder (B) activates the reverse valve operation. Air failure will cause the valve to stay at the position where the operation is disturbed, unlike the valve driven by the Type BS or BWS actuator.

Smooth operation with minimum friction

Extensive use of fluorocarbon resin to coat the inner parts of the actuator reduces friction to a minimum for smooth operation. This includes the inside of the cylinder, resulting in smooth sliding of the piston and O-rings, as well as the surfaces of the driving shaft, piston rod, and all bearings. As a result, the actuator achieves long-term stable operation.

Simple, trouble-free construction

The number of parts has been minimized to reduce mechanical problems and simplify periodic checks, maintenance, disassembly, or reassembly.

Separated turning mechanism and cylinder

Unlike conventional designs, in which the cylinder drive transmission mechanism is incorporated in the cylinder itself, the transmission mechanism of KITZ B Series actuators is designed with a scotch yoke installed separately from the cylinder.

This construction prevents air leakage even when the shaft clearance has increased during service.

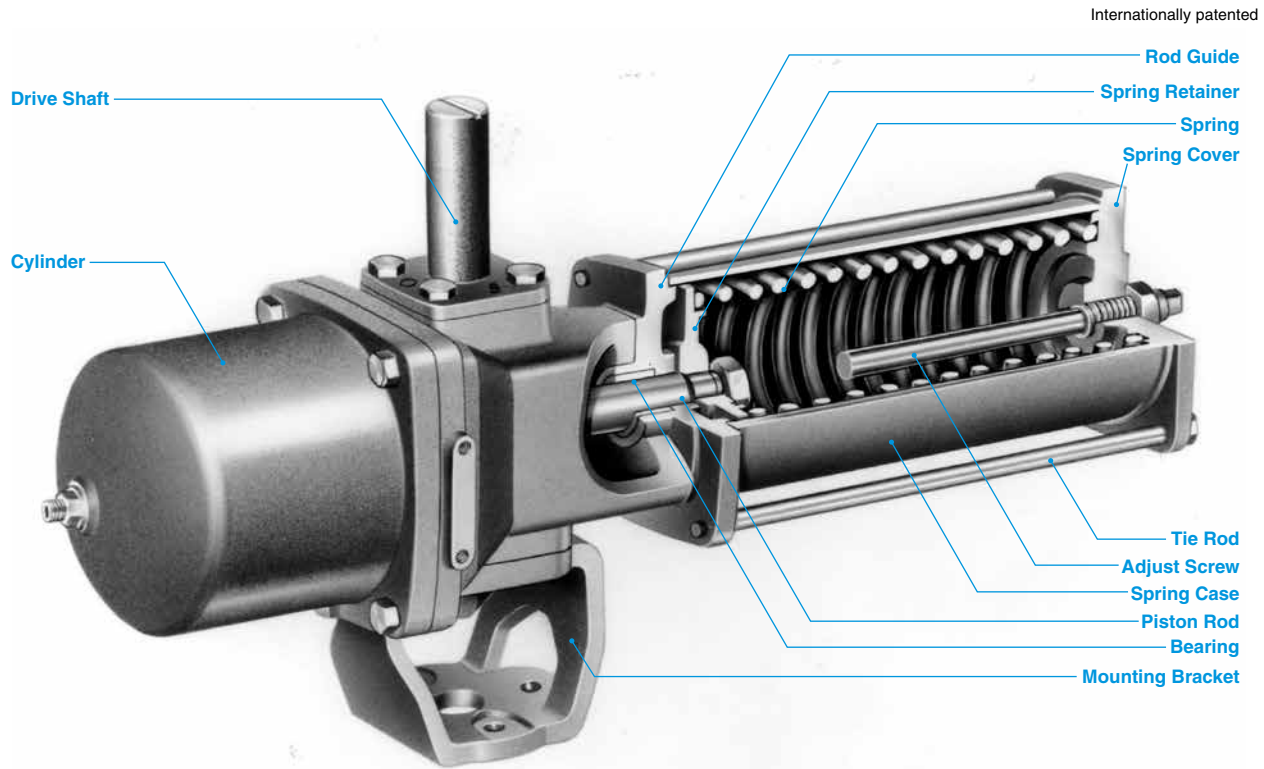
Drive characteristics suited to quarter-turn valves

Unlike conventional cylinder actuators that deploy linear drive characteristics, the use of a scotch yoke mechanism provides a U-shaped curve that maximizes the force obtained at the start and end areas of each stroke. This performance curve is similar to the torque characteristics of ball and butterfly valves in general, making KITZ B Series actuators suitable for such quarter-turn valves (see Page 103).

Installation of accessories

The actuator housing is provided with an arrangement for mounting limit switches and valve positioners, etc., on its top, and solenoid valves, air filters, and regulators on its side.

Type BS (Spring-Return) Type BSW (Spring-Return with Manual Operation Device)



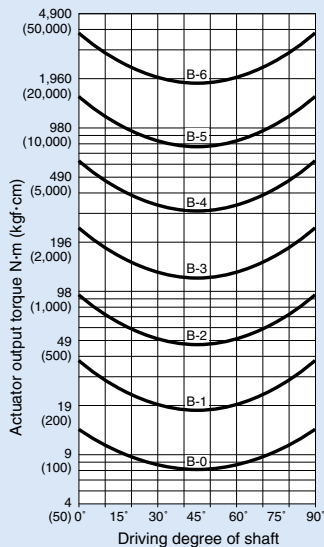
Operational Mechanism

The air pressure supplied into the cylinder pushes the piston outward and energizes its movement to rotate the scotch-yoke counterclockwise, compressing the spring. The scotch-yoke converts linear movement of the piston rod to counterclockwise rotational movement of the drive shaft by 90°, to open or close the valve, following the preset mode.

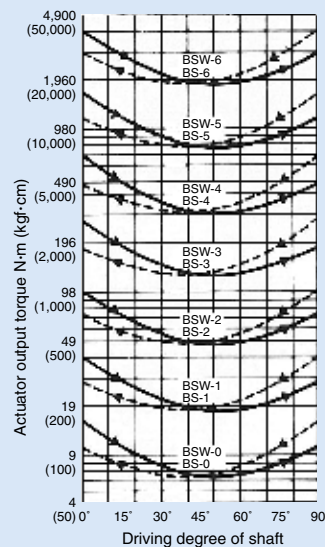
At the moment the air is discharged to the atmosphere through the solenoid valve, the spring force pushes the piston to the reverse direction, and the scotch-yoke activates clockwise rotation of the shaft to reversely operate the valve. Air failure will cause the valve to return to the original open or closed position automatically, following the preset mode, unlike the valve driven by the Type B actuator.

The BSW actuator is driven with the same mechanism as the Type BS, but provided with a handwheel for manual operation. Please bear in mind that the handwheel must be factory mounted.

Type B Actuator Output Torque



Type BS/BSW Actuator Output Torque



— Output torque when air pressure is supplied.
--- Output torque caused by spring force when air pressure is exhausted.

Operating pressure:
0.4 MPa (4 kgf/cm² or 60 psi)

※Please contact KITZ Corporation for B-7, BS-7 and BSW-7.

KITZ F Series Pneumatic Valve Actuators

Characterized by utmost ease of handling and extended service life with high operational efficiency

Easy answers to engineering modification requirements

Economic advantage

Use of monobloc casting of the piston-rack assembly results in a 10% to 15% reduction in the housing dimensions (compared to KITZ D Series actuators) and saves air consumption for valve actuation.

Extended service life with monobloc casting of two pistons and a gear rack

Threads of a gear rack are positioned in the center of the actuator housing, and two pistons are cast in combination with the gear rack as a one-piece unit. This helps to keep the piston position in parallel during actuator travel.

Light and compact housing

Employment of die-cast aluminum for housings and piston-rack assemblies has reduced the actuator weight by 20% to 40% (compared to KITZ D Series actuators) for improved torque to weight ratio.

Conformity to international standards

NAMUR VDI/VDE 3845 designs are for tubeless mounting of a solenoid valve and switchbox on the actuator housing as well as conforming to ISO 5211 requirements for valve mounting flanges. The stem top design also conforms to NAMUR dimensions.

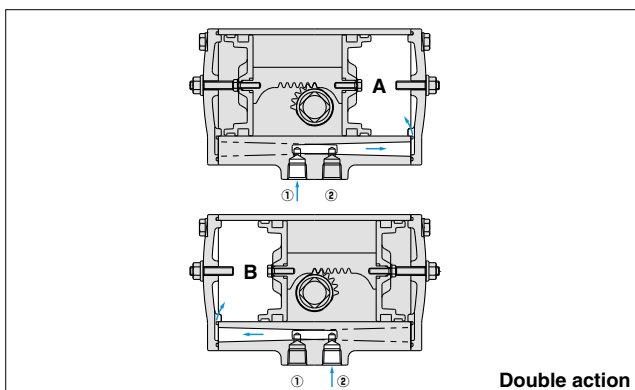
Actuators can be directly mounted to KITZ DJ, XJ Series Butterfly Valves

Optional adaptors (connectors) to the valves at the bottom of the actuators can be provided for various mounting requirements.

Operating Mechanism

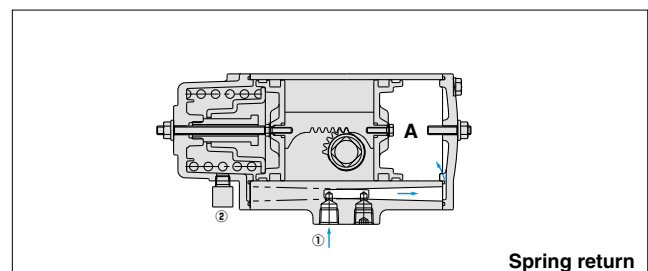
Double action (Type FA)

- (1) Air pressure supplied to chamber **A** through port ① pushes the gear rack with two pistons outward and discharges the air residue through port ②.
- (2) The gear rack rotates the pinion gear and the shaft counterclockwise to drive the valve.
- (3) Reverse supply of the air pressure activates reverse valve operation.



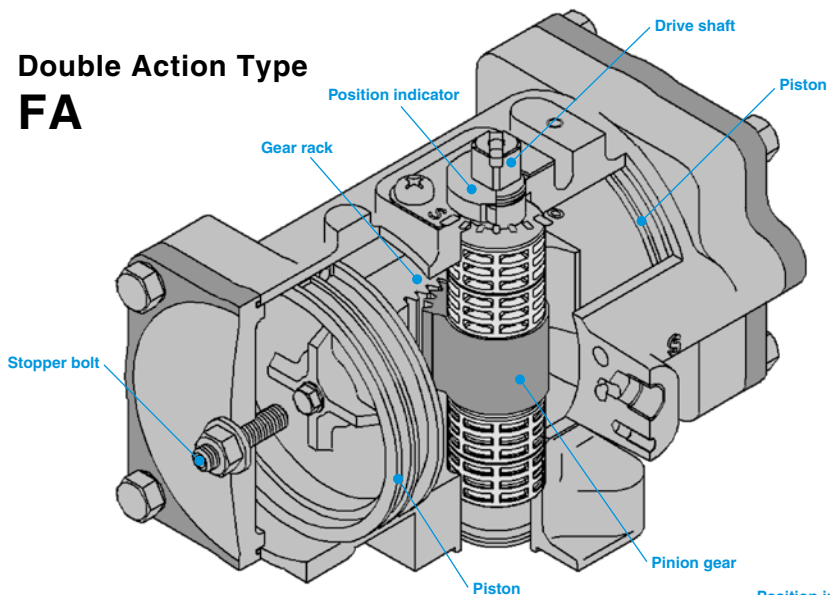
Spring return (Type FAS)

- (1) Air pressure supplied to chamber **A** through port ① pushes the gear rack with two pistons outward, compresses the springs, and discharges the air residue through port ②.
- (2) The gear rack rotates the pinion gear and the shaft counterclockwise to drive the valve.
- (3) At the instant when the air in chamber **A** is discharged through the solenoid valve, the spring force pushes the pistons to the reverse direction and the gear rack activates clockwise rotation of the shaft to reversely operate the valve.

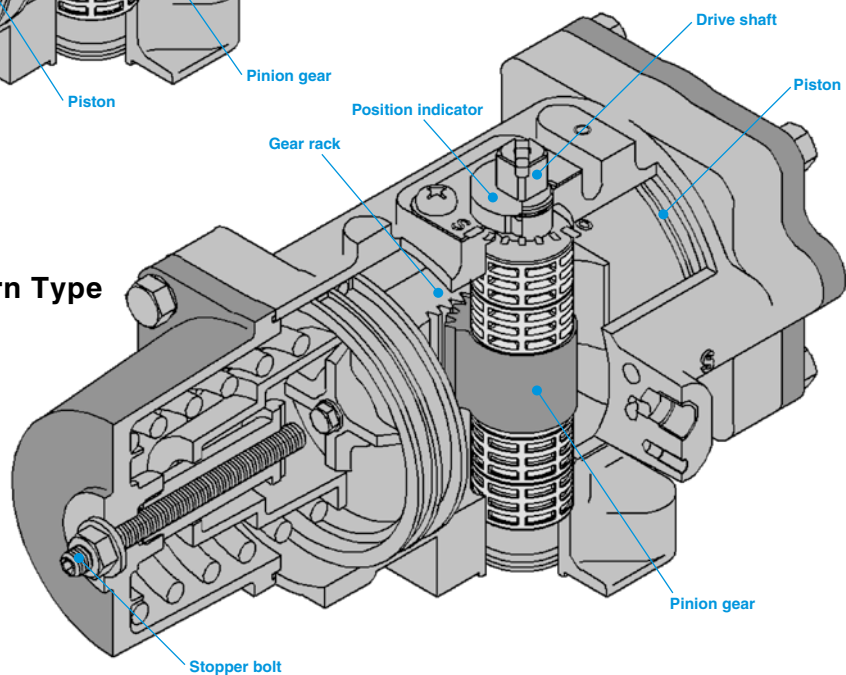


Design Features

Double Action Type FA



Spring Return Type FAS



Specification

Operating medium	Compressed instrumentation air or nitrogen gas
Operating pressure	Standard operating pressure 0.4 MPa
Operating pressure range	0.3 MPa to 0.7 MPa*
Cylinder test pressure	0.97 MPa
Shaft rotating angle	90°±7°
Service temperature	-20°C to +80°C (Supply air should not be frozen.)
Opening degree indication	Indicator has 15 degree graduation
Valve mounting flange	ISO 5211
Accessory mounting connection	NAMUR VDI/VDE 3845
Coating	Baked Polyester Resin Coating

* Be consulted by KITZ for non-standard operating pressure.

Product Coding

FAS-2

Type of actuator

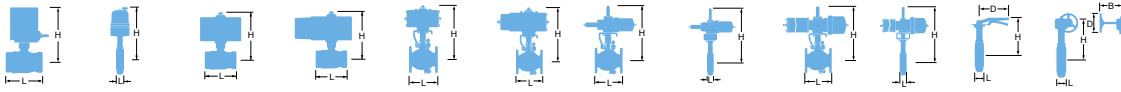
F

Type of operation:

No code...Double action
S.....Spring return

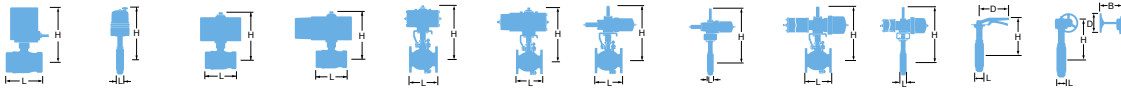
Actuator size:

1...Size 1 4...Size 4
2...Size 2 5...Size 5
3...Size 3 6...Size 6



TYPE	FLOATING BALL					FLOATING BALL			3WAY FLOATING BALL / 3WAY TRUNNION BALL			FLOATING BALL			FLOATING BALL		
Actuators Valves																	
FIG	EA100/200-TE					EA100/200-TFE			EA100/200-TNE			EA100/200-UTE			EA100/200-UTFE		
PRESSURE	10K					10K			10K			10K			10K		
END CONNECTION	BS21 (JIS B0203)					BS21 (JIS B0203)			BS21 (JIS B0203)			BS21 (JIS B0203)			BS21 (JIS B0203)		
DIMENSIONS	inch	mm	L	H	D	L	H	D	L	H	D	L	H	D	L	H	D
	1/4	8	—	—	—	—	—	—	46	101.5	—	44	102	—	—	—	—
	3/8	10	46	104	—	—	—	—	46	101.5	—	44	102	—	—	—	—
	1/2	15	65	109.5	—	63	113.5	—	67	109.5	—	56.5	102	—	62	113.5	—
	3/4	20	68	113.5	—	73	117.5	—	68	114	—	59	105	—	73	117.5	—
	1	25	79	117.5	—	85	128.5	—	79	118	—	71	108	—	85	128.5	—
	1 1/4	32	86	128.5	—	98	142.2	—	89	129.5	—	78	132.5	—	98	143	—
	1 1/2	40	96	142.5	—	108	148.5	—	100	142.5	—	83	135.5	—	108	149	—
2	50	109	148.5	—	—	—	—	115	148.5	—	100	141.5	—	—	—	—	
BODY	Cast Bronze					Forged Brass / Cast Bronze			Cast Bronze			Stainless Steel			Stainless Steel		
CAP	Forged Brass					Forged Brass			Forged Brass			—			Stainless Steel		
STEM	High Tension Brass					High Tension Brass			High Tension Brass			Stainless Steel			Stainless Steel		
BALL	Special Brass					Special Brass			Special Brass			Stainless Steel			Stainless Steel		
SEAT	PTFE					PTFE			PTFE			PTFE			PTFE		
	Standard Port					Full Port			Standard Port			Reduced Port			Full Port		

TYPE	FLOATING BALL					3WAY FLOATING BALL			FLOATING BALL / TRUNNION BALL			3WAY FLOATING BALL / 3WAY TRUNNION BALL			FLOATING BALL		
Actuators Valves																	
FIG	EA100/200-UTGE					EA100/200-UTNE			ED12/24-TE			ED12/24-TNE			ED12/24-UTE		
PRESSURE	10K					10K			10K			10K			10K		
END CONNECTION	BS21 (JIS B0203)					BS21 (JIS B0203)			BS21 (JIS B0203)			BS21 (JIS B0203)			BS21 (JIS B0203)		
DIMENSIONS	inch	mm	L	H	D	L	H	D	L	H	D	L	H	D	L	H	D
	1/4	8	44	128	—	44	101.5	—	—	—	—	46	109.5	—	44	110	—
	3/8	10	44	128	—	44	101.5	—	46	112	—	46	109.5	—	44	110	—
	1/2	15	56.5	128	—	58	106.5	—	65	117.5	—	67	117.5	—	56.5	110	—
	3/4	20	59	131	—	61.5	110.5	—	68	121.5	—	68	122	—	59	113	—
	1	25	71	134	—	74	114	—	79	120.5	—	79	121	—	71	116	—
	1 1/4	32	—	—	—	82.5	132.5	—	86	124.5	—	89	125.5	—	78	128.5	—
	1 1/2	40	—	—	—	90.5	135.5	—	96	138.5	—	100	138.5	—	83	131.5	—
2	50	—	—	—	109.5	141.5	—	109	144.5	—	115	144.5	—	100	137.5	—	
BODY	Stainless Steel					Stainless Steel			Cast Bronze			Cast Bronze			Stainless Steel		
CAP	—					—			Forged Brass			Forged Brass			—		
STEM	Stainless Steel					Stainless Steel			High Tension Brass			High Tension Brass			Stainless Steel		
BALL	Stainless Steel					Stainless Steel			Special Brass			Special Brass			Stainless Steel		
SEAT	REINFORCED PTFE					C/F PTFE			PTFE			PTFE			PTFE		
	Reduced Port					Reduced Port			Standard Port			Standard Port			Reduced Port		



TYPE	FLOATING BALL / TRUNNION BALL			FLOATING BALL			BUTTERFLY			BUTTERFLY			BUTTERFLY				
Actuators Valves																	
FIG	ED12/24-UTFE			ED12/24-UTGE			EXS100/200-10DJ			EXS100/200-10DJE			EXS100/200-10XJME				
PRESSURE	10K			10K			10K			10K			10K				
END CONNECTION	BS21 (JIS B0203)			BS21 (JIS B0203)			Wafer Type (JIS 5K,10K)			Wafer Type (JIS 5K,10K)			Wafer Type (JIS 5K,10K)				
DIMENSIONS	inch	mm	L	H	D	L	H	D	L	H	D	L	H	D	L	H	D
	1/4	8	-	-	-	44	123.5	-	-	-	-	-	-	-	-	-	-
	3/8	10	-	-	-	44	123.5	-	-	-	-	-	-	-	-	-	-
	1/2	15	62	121.5	-	56.5	124	-	-	-	-	-	-	-	-	-	-
	3/4	20	73	121.5	-	59	126.5	-	-	-	-	-	-	-	-	-	-
	1	25	85	125.5	-	71	129.4	-	-	-	-	-	-	-	-	-	-
	1 1/4	32	98	140.5	-	-	-	-	-	-	-	-	-	-	-	-	-
	1 1/2	40	108	146.5	-	-	-	-	-	-	-	-	-	-	33	309	-
	2	50	-	-	-	-	-	-	43	328	-	43	328	-	43	313	-
	2 1/2	65	-	-	-	-	-	-	46	336	-	46	336	-	46	322	-
	3	80	-	-	-	-	-	-	46	354	-	46	354	-	46	330	-
	4	100	-	-	-	-	-	-	52	364	-	52	364	-	52	341	-
	5	125	-	-	-	-	-	-	56	417.5	-	56	417.5	-	56	401	-
	6	150	-	-	-	-	-	-	56	429.5	-	56	429.5	-	56	413.5	-
8	200	-	-	-	-	-	-	60	454.5	-	60	454.5	-	60	440	-	
10	250	-	-	-	-	-	-	68	580	-	68	580	-	68	604	-	
12	300	-	-	-	-	-	-	78	605	-	78	605	-	78	629	-	
14	350	-	-	-	-	-	-	78	717	-	78	717	-	-	-	-	
16	400	-	-	-	-	-	-	102	772	-	102	772	-	-	-	-	
BODY	Stainless Steel			Stainless Steel			Ductile Iron / Cast Iron			Ductile Iron			Aluminum Die-Cast				
CAP	Stainless Steel			-			-			-			-				
STEM	Stainless Steel			Stainless Steel			Stainless Steel			Stainless Steel			Stainless Steel				
BALL	Stainless Steel			Stainless Steel			Ductile Iron+ENP			Ductile Iron+ENP			Stainless Steel				
SEAT	PTFE			REINFORCED PTFE			NBR			EPDM			EPDM				
	Full Port			Reduced Port			Ductile iron (Ni-plated) disc			Ductile iron (Ni-plated) disc							

Bronze & Brass

Cast Iron

Ductile Iron

Stainless Steel

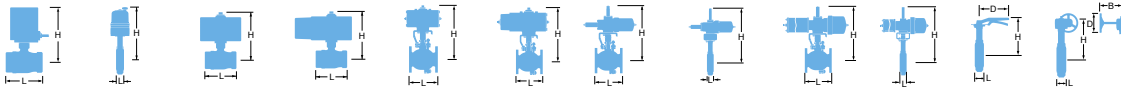
Carbon Steel

Butterfly Valve

Ball Valve

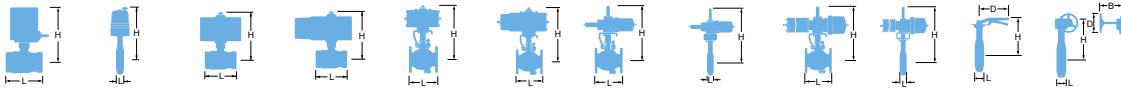
Ball Valve Seal

Actuated Valve



TYPE	FLOATING BALL / TRUNNION BALL					FLOATING BALL / TRUNNION BALL			FLOATING BALL / TRUNNION BALL			3WAY FLOATING BALL / 3WAY TRUNNION BALL			FLOATING BALL		
Actuators Valves																	
FIG	C-TE					C-TFE			C-TLE			C-TNE			C-TUE		
PRESSURE	10K					10K			10K			10K			10K		
END CONNECTION	BS21 (JIS B0203)					BS21 (JIS B0203)			BS21 (JIS B0203)			BS21 (JIS B0203)			BS21 (JIS B0203)		
DIMENSIONS	inch	mm	L	H	D	L	H	D	L	H	D	L	H	D	L	H	D
	1/4	8	—	—	—	—	—	—	—	—	—	46	85.5	—	—	—	—
	3/8	10	46	87.5	—	—	—	—	—	—	—	46	85.5	—	—	—	—
	1/2	15	65	93.5	—	63	97.5	—	56	115.5	—	67	93.5	—	78.5	85.5	—
	3/4	20	68	97.5	—	73	101.5	—	65	120.5	—	68	97.5	—	81	88.5	—
	1	25	79	101.5	—	85	124.5	—	78	123.5	—	79	101.5	—	—	—	—
	1 1/4	32	86	124.5	—	98	138.5	—	86	158.5	—	89	125.5	—	—	—	—
	1 1/2	40	96	137.5	—	108	144.5	—	96	161.5	—	100	138.5	—	—	—	—
2	50	109	144.5	—	—	—	—	109	168.5	—	115	144.5	—	—	—	—	
BODY	Cast Bronze					Forged Brass / Cast Bronze			Cast Bronze			Cast Bronze			Cast Bronze		
CAP	Forged Brass					Forged Brass			Cast Bronze			Forged Brass			—		
STEM	High Tension Brass					High Tension Brass			High Tension Brass			High Tension Brass			High Tension Brass		
BALL	Special Brass					Special Brass			Special Brass			Special Brass			Special Brass		
SEAT	PTFE					PTFE			PTFE			PTFE			PTFE		
	Standard Port					Full Port			Standard Port			Standard Port			Reduced Port		

TYPE	FLOATING BALL					FLOATING BALL			3WAY FLOATING BALL			FLOATING BALL			FLOATING BALL		
Actuators Valves																	
FIG	C-UTE					C-UTGE			C-UTNE			CS-TE			CS-TLE		
PRESSURE	10K					10K			10K			10K			10K		
END CONNECTION	BS21 (JIS B0203)					BS21 (JIS B0203)			BS21 (JIS B0203)			BS21 (JIS B0203)			BS21 (JIS B0203)		
DIMENSIONS	inch	mm	L	H	D	L	H	D	L	H	D	L	H	D	L	H	D
	1/4	8	44	85.5	—	44	105.5	—	44	85	—	—	—	—	—	—	—
	3/8	10	44	85.5	—	44	105.5	—	44	85	—	46	87.5	—	—	—	—
	1/2	15	56.5	85.5	—	56.5	124.5	—	58	90	—	65	112.5	—	56	134.5	—
	3/4	20	59	88.5	—	59	127.5	—	61.5	94	—	68	116.5	—	65	139.5	—
	1	25	71	91.5	—	71	130.5	—	74	97.5	—	79	120.5	—	78	142.5	—
	1 1/4	32	78	128.5	—	—	—	—	82.5	128	—	—	—	—	—	—	—
	1 1/2	40	83	131.5	—	—	—	—	90.5	131	—	—	—	—	—	—	—
2	50	100	137.5	—	—	—	—	109.5	137	—	—	—	—	—	—	—	
BODY	Stainless Steel					Stainless Steel			Stainless Steel			Cast Bronze			Cast Bronze		
CAP	—					—			—			Forged Brass			Cast Bronze		
STEM	Stainless Steel					Stainless Steel			Stainless Steel			High Tension Brass			High Tension Brass		
BALL	Stainless Steel					Stainless Steel			Stainless Steel			Special Brass			Special Brass		
SEAT	PTFE					REINFORCED PTFE			C/F PTFE			PTFE			PTFE		
	Reduced Port					Reduced Port			Reduced Port			Standard Port			Standard Port		



TYPE	3WAY FLOATING BALL					FLOATING BALL				FLOATING BALL			FLOATING BALL			3WAY FLOATING BALL		
Actuators Valves																		
FIG	CS-TNE					CS-TUE				CS-UTE			CS-UTGE			CS-UTNE		
PRESSURE	10K					10K				10K			10K			10K		
END CONNECTION	BS21 (JIS B0203)					BS21 (JIS B0203)				BS21 (JIS B0203)			BS21 (JIS B0203)			BS21 (JIS B0203)		
DIMENSIONS	inch	mm	L	H	D	L	H	D	L	H	D	L	H	D	L	H	D	
	1/4	8	46	85.5	—	—	—	—	44	85.5	—	44	124.5	—	44	85	—	
	3/8	10	46	85.5	—	—	—	—	44	85.5	—	44	124.5	—	44	85	—	
	1/2	15	67	112.5	—	78.5	104.5	—	56.5	104.5	—	—	—	—	58	109	—	
	3/4	20	68	116.5	—	81	107.5	—	59	107.5	—	—	—	—	61.5	113	—	
1	25	79	120.5	—	—	—	—	71	110.5	—	—	—	—	74	116.5	—		
BODY	Cast Bronze					Cast Bronze				Stainless Steel			Stainless Steel			Stainless Steel		
CAP	Forged Brass					—				—			—			—		
STEM	High Tension Brass					High Tension Brass				Stainless Steel			Stainless Steel			Stainless Steel		
BALL	Special Brass					Special Brass				Stainless Steel			Stainless Steel			Stainless Steel		
SEAT	PTFE					PTFE				PTFE			Reinforced PTFE			C/F PTFE		
	Standard Port					Reduced Port				Reduced Port			Reduced Port			Reduced Port		

TYPE	FLOATING BALL					FLOATING BALL				3WAY FLOATING BALL			FLOATING BALL			FLOATING BALL		
Actuators Valves																		
FIG	FA-10FCT					FA-10FCTB				FA-10FCTB2L			FA-10SCTDZ			FA-10UT		
PRESSURE	10K					10K				10K			10K			10K		
END CONNECTION	BS21 (JIS B0203)					JIS B2239				JIS B2239			JIS B2220			BS21 (JIS B0203)		
DIMENSIONS	inch	mm	L	H	D	L	H	D	L	H	D	L	H	D	L	H	D	
	3/8	10	72	216	—	—	—	—	—	—	—	—	—	—	62	216	—	
	1/2	15	80	225	—	110	225	—	—	—	—	108	215	—	65	225	—	
	3/4	20	85	228	—	120	228	—	—	—	—	117	218	—	80	228	—	
	1	25	95	235	—	130	235	—	—	—	—	127	240	—	90	235	—	
	1 1/4	32	120	239	—	140	239	—	—	—	—	—	—	—	110	239	—	
	1 1/2	40	120	297	—	165	297	—	210	297	—	165	297	—	120	297	—	
	2	50	140	304	—	180	304	—	220	306	—	178	306	—	140	304	—	
	2 1/2	65	160	345	—	190	345	—	250	347	—	190	363	—	160	345	—	
	3	80	182	413	—	200	413	—	260	413	—	203	419	—	182	413	—	
4	100	—	—	—	230	436	—	330	440	—	229	447	—	—	—	—		
5	125	—	—	—	300	520	—	—	—	—	356	519	—	—	—	—		
6	150	—	—	—	340	545	—	—	—	—	394	552	—	—	—	—		
8	200	—	—	—	450	628	—	—	—	—	457	656	—	—	—	—		
BODY	Cast Iron					Cast Iron				Cast Iron			Cast Steel			Stainless Steel		
CAP	Cast Iron					Cast Iron				Cast Iron			Cast Steel			Stainless Steel		
STEM	Stainless Steel					Stainless Steel				Stainless Steel			Stainless Steel			Stainless Steel		
BALL	Stainless Steel					Stainless Steel				Stainless Steel			Stainless Steel			Stainless Steel		
SEAT	PTFE					PTFE				PTFE			HYPATITE® PTFE			PTFE		
	Full Port					Full Port				Full Port			Full Port			Full Port		

Bronze & Brass

Cast Iron

Ductile Iron

Stainless Steel

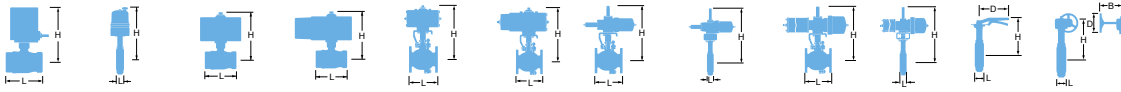
Carbon Steel

Buttery Valve

Ball Valve

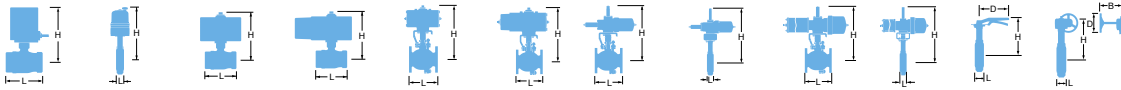
Ball Valve Seal

Actuated Valve



TYPE		3WAY FLOATING BALL			3WAY FLOATING BALL			FLOATING BALL			FLOATING BALL			FLOATING BALL			
Actuators Valves																	
FIG		FA-10UTB2L			FA-10UTB4LA			FA-10UTBLN			FA-10UTDZ			FA-150SCTDZ			
PRESSURE		10K			10K			10K			10K			Class 150			
END CONNECTION		JIS B2220			JIS B2220			JIS B2220			JIS B2220			ASME B16.5			
DIMENSIONS	inch	mm	L	H	D	L	H	D	L	H	D	L	H	D	L	H	D
	1/2	15	—	—	—	120	237	—	140	228	—	108	215	—	108	215	—
	3/4	20	—	—	—	140	263	—	152	229	—	117	218	—	117	218	—
	1	25	165	235	—	160	267	—	165	240	—	127	240	—	127	240	—
	1 1/4	32	—	—	—	—	—	—	—	—	—	140	244	—	—	—	—
	1 1/2	40	210	297	—	180	335	—	191	301	—	165	297	—	165	297	—
	2	50	220	304	—	200	403	—	216	307	—	178	306	—	178	306	—
	2 1/2	65	250	347	—	240	422	—	240	347	—	190	363	—	190	363	—
	3	80	260	413	—	260	498	—	250	416	—	203	419	—	203	419	—
	4	100	330	440	—	330	549	—	280	442	—	229	447	—	229	447	—
	5	125	—	—	—	400	585	—	—	—	—	356	519	—	356	519	—
	6	150	—	—	—	—	—	—	—	—	—	394	552	—	394	552	—
	8	200	—	—	—	—	—	—	—	—	—	457	656	—	457	656	—
BODY		Stainless Steel			Stainless Steel			Stainless Steel			Stainless Steel			Cast Steel			
CAP		Stainless Steel			Stainless Steel			Stainless Steel			Stainless Steel			Cast Steel			
STEM		Stainless Steel			Stainless Steel			Stainless Steel			Stainless Steel			Stainless Steel			
BALL		Stainless Steel			Stainless Steel			Stainless Steel			Stainless Steel			Stainless Steel			
SEAT		HYPATITE® PTFE			HYPATITE® PTFE			HYPATITE® PTFE			HYPATITE® PTFE			HYPATITE® PTFE			
		Full Port			Full Port			Full Port			Full Port			Full Port			

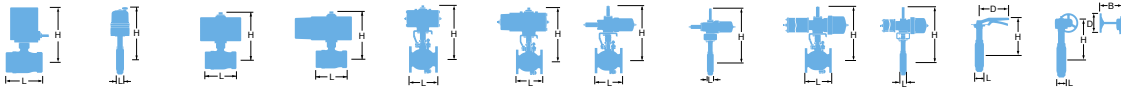
TYPE		FLOATING BALL			FLOATING BALL			FLOATING BALL			FLOATING BALL			FLOATING BALL			
Actuators Valves																	
FIG		FA-150UTDZ			FA-20SCTDZ			FA-20UTDZ			FA-300SCTDZ			FA-300UTDZ			
PRESSURE		Class 150			20K			20K			Class 300			Class 300			
END CONNECTION		ASME B16.5			JIS B2220			JIS B2220			ASME B16.5			ASME B16.5			
DIMENSIONS	inch	mm	L	H	D	L	H	D	L	H	D	L	H	D	L	H	D
	1/2	15	108	215	—	140	215	—	140	215	—	140	215	—	140	215	—
	3/4	20	117	218	—	152	218	—	152	218	—	152	218	—	152	218	—
	1	25	127	240	—	165	240	—	165	240	—	165	240	—	165	240	—
	1 1/4	32	140	244	—	—	—	—	178	244	—	—	—	—	—	—	—
	1 1/2	40	165	297	—	190	297	—	190	297	—	190	297	—	190	297	—
	2	50	178	306	—	216	306	—	216	306	—	216	306	—	216	306	—
	2 1/2	65	190	363	—	241	363	—	241	363	—	241	363	—	241	363	—
	3	80	203	419	—	283	419	—	283	419	—	283	419	—	283	419	—
	4	100	229	447	—	305	447	—	305	447	—	305	447	—	305	447	—
	5	125	356	519	—	381	519	—	381	519	—	—	—	—	—	—	—
	6	150	394	552	—	403	552	—	403	552	—	403	552	—	403	552	—
	8	200	457	656	—	502	656	—	502	656	—	502	656	—	502	656	—
BODY		Stainless Steel			Cast Steel			Stainless Steel			Cast Steel			Stainless Steel			
CAP		Stainless Steel			Cast Steel			Stainless Steel			Cast Steel			Stainless Steel			
STEM		Stainless Steel			Stainless Steel			Stainless Steel			Stainless Steel			Stainless Steel			
BALL		Stainless Steel			Stainless Steel			Stainless Steel			Stainless Steel			Stainless Steel			
SEAT		HYPATITE® PTFE			HYPATITE® PTFE			HYPATITE® PTFE			HYPATITE® PTFE			HYPATITE® PTFE			
		Full Port			Full Port			Full Port			Full Port			Full Port			



TYPE	FLOATING BALL			BUTTERFLY			BUTTERFLY			BUTTERFLY			FLOATING BALL				
Actuators Valves																	
FIG	FA-300UTDZM			FA-10XJME			FA-10DJ			FA-10DJE			FAS-10FCT				
PRESSURE	Class 300			10K			10K			10K			10K				
END CONNECTION	ASME B16.5			Wafer Type (JIS 5K,10K)			Wafer Type (JIS 5K,10K)			Wafer Type (JIS 5K,10K)			BS21 (JIS B0203)				
DIMENSIONS	inch	mm	L	H	D	L	H	D	L	H	D	L	H	D	L	H	D
	3/8	10	-	-	-	-	-	-	-	-	-	-	-	-	72	216	-
	1/2	15	140	215	-	-	-	-	-	-	-	-	-	-	80	225	-
	3/4	20	152	218	-	-	-	-	-	-	-	-	-	-	85	228	-
	1	25	165	240	-	-	-	-	-	-	-	-	-	-	95	258	-
	1 1/4	32	-	-	-	-	-	-	-	-	-	-	-	-	120	262	-
	1 1/2	40	190	297	-	33	251	-	-	-	-	-	-	-	120	313	-
	2	50	216	306	-	43	255	-	43	270	-	43	270	-	140	343	-
	2 1/2	65	241	363	-	46	287	-	46	278	-	46	278	-	160	404	-
	3	80	283	419	-	46	295	-	46	319	-	46	319	-	182	468	-
	4	100	305	447	-	52	306	-	52	329	-	52	329	-	-	-	-
	5	125	-	-	-	56	357	-	56	373	-	56	373	-	-	-	-
6	150	403	552	-	56	369	-	56	385	-	56	385	-	-	-	-	
8	200	502	656	-	60	435	-	60	449	-	60	449	-	-	-	-	
10	250	-	-	-	68	573	-	68	549	-	68	549	-	-	-	-	
12	300	-	-	-	78	627	-	78	603	-	78	603	-	-	-	-	
BODY	Stainless Steel			Aluminum Die-Cast			Ductile Iron			Ductile Iron			Cast Iron				
CAP	Stainless Steel			-			-			-			Cast Iron				
STEM	Stainless Steel			Stainless Steel			Stainless Steel			Stainless Steel			Stainless Steel				
BALL	Stainless Steel			Stainless Steel			Ductile Iron+ENP			Ductile Iron+ENP			Stainless Steel				
SEAT	HYPATITE® PTFE			EPDM			NBR			EPDM			PTFE				
	Full Port						Ductile iron (Ni-plated) disc			Ductile iron (Ni-plated) disc			Full Port				

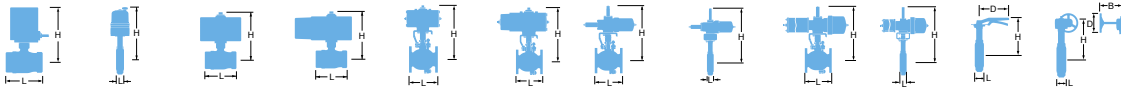
TYPE	FLOATING BALL			3WAY FLOATING BALL			FLOATING BALL			FLOATING BALL			3WAY FLOATING BALL				
Actuators Valves																	
FIG	FAS-10FCTB			FAS-10FCTB2L			FAS-10SCTDZ			FAS-10UT			FAS-10UTB2L				
PRESSURE	10K			10K			10K			10K			10K				
END CONNECTION	JIS B2239			JIS B2239			JIS B2220			BS21 (JIS B0203)			JIS B2220				
DIMENSIONS	inch	mm	L	H	D	L	H	D	L	H	D	L	H	D	L	H	D
	3/8	10	-	-	-	-	-	-	-	-	-	62	216	-	-	-	-
	1/2	15	110	225	-	-	-	-	108	215	-	65	225	-	-	-	-
	3/4	20	120	228	-	-	-	-	117	241	-	80	228	-	-	-	-
	1	25	130	258	-	-	-	-	127	276	-	90	258	-	165	258	-
	1 1/4	32	140	262	-	-	-	-	-	-	-	110	262	-	-	-	-
	1 1/2	40	165	313	-	210	313	-	165	313	-	120	313	-	210	313	-
	2	50	180	343	-	220	345	-	178	355	-	140	343	-	220	345	-
	2 1/2	65	190	404	-	250	406	-	190	409	-	160	404	-	250	406	-
	3	80	200	468	-	260	468	-	203	475	-	182	468	-	260	468	-
4	100	230	500	-	330	504	-	229	503	-	-	-	-	330	504	-	
5	125	300	549	-	-	-	-	356	548	-	-	-	-	-	-	-	
6	150	340	574	-	-	-	-	394	581	-	-	-	-	-	-	-	
BODY	Cast Iron			Cast Iron			Cast Steel			Stainless Steel			Stainless Steel				
CAP	Cast Iron			Cast Iron			Cast Steel			Stainless Steel			Stainless Steel				
STEM	Stainless Steel			Stainless Steel			Stainless Steel			Stainless Steel			Stainless Steel				
BALL	Stainless Steel			Stainless Steel			Stainless Steel			Stainless Steel			Stainless Steel				
SEAT	PTFE			PTFE			HYPATITE® PTFE			PTFE			HYPATITE® PTFE				
	Full Port			Full Port			Full Port			Full Port			Full Port				

Bronze & Brass
 Cast Iron
 Ductile Iron
 Stainless Steel
 Carbon Steel
 Butterfly Valve
 Ball Valve
 Ball Valve Seal
 Actuated Valve



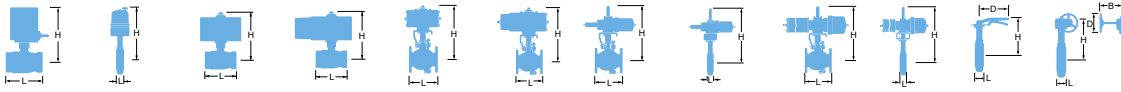
TYPE	3WAY FLOATING BALL					FLOATING BALL			FLOATING BALL			FLOATING BALL			FLOATING BALL		
Actuators Valves																	
FIG	FAS-10UTB4LA					FAS-10UTBLN			FAS-10UTDZ			FAS-150SCTDZ			FAS-150UTDZ		
PRESSURE	10K					10K			10K			Class 150			Class 150		
END CONNECTION	JIS B2220					JIS B2220			JIS B2220			ASME B16.5			ASME B16.5		
DIMENSIONS	inch	mm	L	H	D	L	H	D	L	H	D	L	H	D	L	H	D
	1/2	15	120	260	—	140	228	—	108	215	—	108	215	—	108	215	—
	3/4	20	140	279	—	152	229	—	117	241	—	117	241	—	117	241	—
	1	25	160	283	—	165	263	—	127	276	—	127	276	—	127	276	—
	1 1/4	32	—	—	—	—	—	—	140	280	—	—	—	—	140	280	—
	1 1/2	40	180	394	—	191	317	—	165	313	—	165	313	—	165	313	—
	2	50	200	458	—	216	346	—	178	355	—	178	355	—	178	355	—
	2 1/2	65	240	515	—	240	406	—	190	409	—	190	409	—	190	409	—
	3	80	260	527	—	250	471	—	203	475	—	203	475	—	203	475	—
	4	100	—	—	—	280	506	—	229	503	—	229	503	—	229	503	—
	5	125	—	—	—	—	—	—	356	548	—	356	548	—	356	548	—
	6	150	—	—	—	—	—	—	394	581	—	394	581	—	394	581	—
BODY	Stainless Steel					Stainless Steel			Stainless Steel			Cast Steel			Stainless Steel		
CAP	Stainless Steel					Stainless Steel			Stainless Steel			Cast Steel			Stainless Steel		
STEM	Stainless Steel					Stainless Steel			Stainless Steel			Stainless Steel			Stainless Steel		
BALL	Stainless Steel					Stainless Steel			Stainless Steel			Stainless Steel			Stainless Steel		
SEAT	HYPATITE® PTFE					HYPATITE® PTFE			HYPATITE® PTFE			HYPATITE® PTFE			HYPATITE® PTFE		
	Full Port					Full Port			Full Port			Full Port			Full Port		

TYPE	FLOATING BALL					FLOATING BALL			FLOATING BALL			FLOATING BALL			FLOATING BALL		
Actuators Valves																	
FIG	FAS-150UTDZM					FAS-20SCTDZ			FAS-20UTDZ			FAS-300SCTDZ			FAS-300UTDZM		
PRESSURE	Class 150					20K			20K			Class 300			Class 300		
END CONNECTION	ASME B16.5					JIS B2220			JIS B2220			ASME B16.5			ASME B16.5		
DIMENSIONS	inch	mm	L	H	D	L	H	D	L	H	D	L	H	D	L	H	D
	1/2	15	108	215	—	140	215	—	140	215	—	140	215	—	140	215	—
	3/4	20	117	241	—	152	241	—	152	241	—	152	241	—	152	241	—
	1	25	127	276	—	165	276	—	165	276	—	165	276	—	165	276	—
	1 1/4	32	140	280	—	—	—	—	178	280	—	—	—	—	—	—	—
	1 1/2	40	165	313	—	190	313	—	190	313	—	190	313	—	190	313	—
	2	50	178	355	—	216	355	—	216	355	—	216	355	—	216	355	—
	2 1/2	65	190	409	—	241	409	—	241	409	—	241	409	—	241	409	—
	3	80	203	475	—	283	475	—	283	475	—	283	475	—	283	475	—
	4	100	229	503	—	305	503	—	305	503	—	305	503	—	305	503	—
	5	125	356	548	—	381	548	—	381	548	—	—	—	—	—	—	—
	6	150	394	581	—	403	581	—	403	581	—	403	581	—	403	581	—
BODY	Stainless Steel					Cast Steel			Stainless Steel			Cast Steel			Stainless Steel		
CAP	Stainless Steel					Cast Steel			Stainless Steel			Cast Steel			—		
BONNET	—					—			—			—			Stainless Steel		
STEM	Stainless Steel					Stainless Steel			Stainless Steel			Stainless Steel			Stainless Steel		
BALL / DISC	Stainless Steel					Stainless Steel			Stainless Steel			Stainless Steel			Stainless Steel		
SEAT	HYPATITE® PTFE					HYPATITE® PTFE			HYPATITE® PTFE			HYPATITE® PTFE			HYPATITE® PTFE		
	Full Port					Full Port			Full Port			Full Port			Full Port		



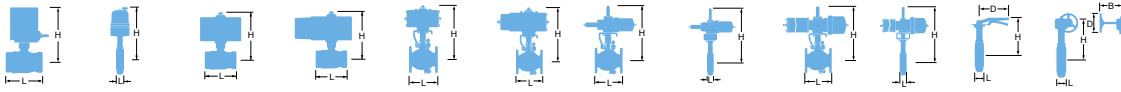
TYPE	FLOATING BALL					BUTTERFLY			BUTTERFLY			BUTTERFLY			BUTTERFLY		
Actuators Valves																	
FIG	FAS-300UTDZ					FAS-10XJME			FAS-10DJ			FAS-10DJE			FAS-10LJF		
PRESSURE	Class 300					10K			10K			10K			10K		
END CONNECTION	ASME B16.5					Wafer Type (JIS 5K,10K)			Wafer Type (JIS 5K,10K)			Wafer Type (JIS 5K,10K)			Wafer Type (JIS 10K)		
DIMENSIONS	inch	mm	L	H	D	L	H	D	L	H	D	L	H	D	L	H	D
	1/2	15	140	215	-	-	-	-	-	-	-	-	-	-	-	-	-
	3/4	20	152	241	-	-	-	-	-	-	-	-	-	-	-	-	-
	1	25	165	276	-	-	-	-	-	-	-	-	-	-	-	-	-
	1 1/2	40	190	313	-	33	274	-	-	-	-	-	-	-	-	-	-
	2	50	216	355	-	43	278	-	43	293	-	43	293	-	43	284	-
	2 1/2	65	241	409	-	46	303	-	46	301	-	46	301	-	46	334	-
	3	80	283	475	-	46	311	-	46	335	-	46	335	-	46	342	-
	4	100	305	503	-	52	364	-	52	384	-	52	384	-	52	391	-
	5	125	-	-	-	56	396	-	56	412	-	56	412	-	56	455	-
	6	150	403	581	-	56	452	-	56	468	-	56	468	-	56	468	-
8	200	-	-	-	60	508	-	60	522	-	60	522	-	-	-	-	
10	250	-	-	-	-	-	-	68	578	-	68	578	-	-	-	-	
BODY	Stainless Steel					Aluminum Die-Cast			Ductile Iron			Ductile Iron			Ductile Iron		
BONNET	Stainless Steel					-			-			-			-		
STEM	Stainless Steel					Stainless Steel			Stainless Steel			Stainless Steel			Stainless Steel		
BALL / DISC	Stainless Steel					Stainless Steel			Ductile Iron+ENP			Ductile Iron+ENP			Stainless Steel+PFA		
SEAT	HYPATITE® PTFE					EPDM			NBR			EPDM			-		
	Full Port								Ductile iron (Ni-plated) disc			Ductile iron (Ni-plated) disc					

TYPE	FLOATING BALL					FLOATING BALL			3WAY FLOATING BALL			FLOATING BALL			FLOATING BALL		
Actuators Valves																	
FIG	B-10FCT					B-10FCTB			B-10FCTB2L			B-10STLBF			B-10UT		
PRESSURE	10K					10K			10K			10K			10K		
END CONNECTION	BS21 (JIS B0203)					JIS B2239			JIS B2239			JIS B2239			BS21 (JIS B0203)		
DIMENSIONS	inch	mm	L	H	D	L	H	D	L	H	D	L	H	D	L	H	D
	3/8	10	72	202	-	-	-	-	-	-	-	-	-	-	62	202	-
	1/2	15	80	212	-	110	212	-	-	-	-	108	216	-	65	212	-
	3/4	20	85	215	-	120	215	-	-	-	-	117	219	-	80	215	-
	1	25	95	222	-	130	222	-	-	-	-	127	227	-	90	222	-
	1 1/4	32	120	298	-	140	298	-	-	-	-	140	302	-	110	298	-
	1 1/2	40	120	318	-	165	318	-	210	318	-	165	318	-	120	318	-
	2	50	140	365	-	180	365	-	220	367	-	178	365	-	140	365	-
	2 1/2	65	160	390	-	190	390	-	250	392	-	190	390	-	160	390	-
	3	80	182	464	-	200	464	-	260	464	-	203	464	-	182	464	-
	4	100	-	-	-	230	487	-	330	491	-	229	487	-	-	-	-
5	125	-	-	-	300	600	-	-	-	-	356	600	-	-	-	-	
6	150	-	-	-	340	625	-	-	-	-	394	625	-	-	-	-	
8	200	-	-	-	450	712	-	-	-	-	457	712	-	-	-	-	
10	250	-	-	-	533	772	-	-	-	-	-	-	-	-	-	-	
BODY	Cast Iron					Cast Iron			Cast Iron			Ductile Iron			Stainless Steel		
BONNET	Cast Iron					Cast Iron			Cast Iron			Ductile Iron			Stainless Steel		
STEM	Stainless Steel					Stainless Steel			Stainless Steel			Stainless Steel			Stainless Steel		
BALL	Stainless Steel					Stainless Steel			Stainless Steel			Stainless Steel			Stainless Steel		
SEAT	PTFE					PTFE			PTFE			PTFE			PTFE		
	Full Port					Full Port			Full Port			Full Port			Full Port		



TYPE		FLOATING BALL					FLOATING BALL					3WAY FLOATING BALL					3WAY FLOATING BALL									
Actuators Valves																										
FIG		B-10UTDZ					B-10UTDZM					B-10SCTDZ					B-10UTB2L					B-10UTB4LA				
PRESSURE		10K					10K					10K					10K					10K				
END CONNECTION		JIS B2220					JIS B2220					JIS B2220					JIS B2220					JIS B2220				
DIMENSIONS	inch	mm	L	H	D	L	H	D	L	H	D	L	H	D	L	H	D	L	H	D						
	1/2	15	108	202	—	108	202	—	108	202	—	—	—	—	120	296	—	—	—	—						
	3/4	20	117	205	—	117	205	—	117	205	—	—	—	140	299	—	—	—	—							
	1	25	127	299	—	127	299	—	127	299	—	165	207	—	160	303	—	—	—							
	1 1/4	32	140	303	—	140	303	—	—	—	—	—	—	—	—	—	—	—	—							
	1 1/2	40	165	358	—	165	358	—	165	358	—	210	318	—	180	380	—	—	—							
	2	50	178	367	—	178	367	—	178	367	—	220	367	—	200	454	—	—	—							
	2 1/2	65	190	408	—	190	408	—	190	408	—	250	392	—	240	473	—	—	—							
	3	80	203	470	—	203	470	—	203	470	—	260	464	—	260	578	—	—	—							
	4	100	229	498	—	229	498	—	229	498	—	330	491	—	330	600	—	—	—							
	5	125	356	599	—	356	599	—	356	599	—	—	—	—	—	—	—	—	—							
	6	150	394	632	—	394	632	—	394	632	—	—	—	—	—	—	—	—	—							
	8	200	457	740	—	457	740	—	457	740	—	—	—	—	—	—	—	—	—							
	10	250	533	783	—	533	783	—	533	783	—	—	—	—	—	—	—	—	—							
BODY		Stainless Steel					Stainless Steel					Cast Steel					Stainless Steel					Stainless Steel				
BONNET		Stainless Steel					Stainless Steel					Cast Steel					Stainless Steel					Stainless Steel				
STEM		Stainless Steel					Stainless Steel					Stainless Steel					Stainless Steel					Stainless Steel				
BALL		Stainless Steel					Stainless Steel					Stainless Steel					Stainless Steel					Stainless Steel				
SEAT		HYPATITE® PTFE					HYPATITE® PTFE					HYPATITE® PTFE					HYPATITE® PTFE					HYPATITE® PTFE				
		Full Port					Full Port					Full Port					Full Port					Full Port				

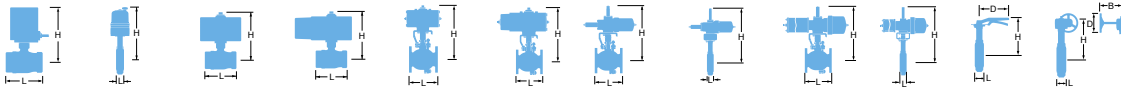
TYPE		FLOATING BALL					FLOATING BALL					FLOATING BALL					FLOATING BALL					FLOATING BALL				
Actuators Valves																										
FIG		B-10UTBLN					B-150SCTDZ					B-150UTDZ					B-150UTDZM					B-20SCTDZ				
PRESSURE		10K					Class 150					Class 150					Class 150					20K				
END CONNECTION		JIS B2220					ASME B16.5					ASME B16.5					ASME B16.5					JIS B2220				
DIMENSIONS	inch	mm	L	H	D	L	H	D	L	H	D	L	H	D	L	H	D	L	H	D						
	1/2	15	140	215	—	108	202	—	108	202	—	108	202	—	140	202	—	140	202	—						
	3/4	20	152	217	—	117	205	—	117	205	—	117	205	—	152	205	—	152	205	—						
	1	25	165	227	—	127	299	—	127	299	—	127	299	—	165	299	—	165	299	—						
	1 1/4	32	—	—	—	—	—	—	140	303	—	140	303	—	—	—	—	—	—							
	1 1/2	40	191	322	—	165	358	—	165	358	—	165	358	—	190	358	—	190	358	—						
	2	50	216	368	—	178	367	—	178	367	—	178	367	—	216	367	—	216	367	—						
	2 1/2	65	240	392	—	190	408	—	190	408	—	190	408	—	241	408	—	241	408	—						
	3	80	250	467	—	203	470	—	203	470	—	203	470	—	283	470	—	283	470	—						
	4	100	280	493	—	229	498	—	229	498	—	229	498	—	305	498	—	305	498	—						
	5	125	—	—	—	356	599	—	356	599	—	356	599	—	381	599	—	381	599	—						
	6	150	—	—	—	394	632	—	394	632	—	394	632	—	403	632	—	403	632	—						
	8	200	—	—	—	457	740	—	457	740	—	457	740	—	502	740	—	502	740	—						
	10	250	—	—	—	533	783	—	533	783	—	533	783	—	—	—	—	—	—							
BODY		Stainless Steel					Cast Steel					Stainless Steel					Stainless Steel					Cast Steel				
BONNET		Stainless Steel					Cast Steel					Stainless Steel					Stainless Steel					Cast Steel				
STEM		Stainless Steel					Stainless Steel					Stainless Steel					Stainless Steel					Stainless Steel				
BALL		Stainless Steel					Stainless Steel					Stainless Steel					Stainless Steel					Stainless Steel				
SEAT		HYPATITE® PTFE					HYPATITE® PTFE					HYPATITE® PTFE					HYPATITE® PTFE					HYPATITE® PTFE				
		Full Port					Full Port					Full Port					Full Port					Full Port				



TYPE	FLOATING BALL					FLOATING BALL			FLOATING BALL			FLOATING BALL			FLOATING BALL		
Actuators Valves																	
FIG	B-20UTDZ					B-20UTDZM			B-300SCTDZ			B-300UTDZ			B-300UTDZM		
PRESSURE	20K					20K			Class 300			Class 300			Class 300		
END CONNECTION	JIS B2220					JIS B2220			ASME B16.5			ASME B16.5			ASME B16.5		
DIMENSIONS	inch	mm	L	H	D	L	H	D	L	H	D	L	H	D	L	H	D
	1/2	15	140	202	—	140	202	—	140	202	—	140	202	—	140	202	—
	3/4	20	152	205	—	152	205	—	152	205	—	152	205	—	152	205	—
	1	25	165	299	—	165	299	—	165	299	—	165	299	—	165	299	—
	1 1/4	32	178	303	—	178	303	—	—	—	—	—	—	—	—	—	—
	1 1/2	40	190	358	—	190	358	—	190	358	—	190	358	—	190	358	—
	2	50	216	367	—	216	367	—	216	367	—	216	367	—	216	367	—
	2 1/2	65	241	408	—	241	408	—	241	408	—	241	408	—	241	408	—
	3	80	283	470	—	283	470	—	283	470	—	283	470	—	283	470	—
	4	100	305	498	—	305	498	—	305	498	—	305	498	—	305	498	—
5	125	381	599	—	381	599	—	—	—	—	—	—	—	—	—	—	
6	150	403	632	—	403	632	—	403	632	—	403	632	—	403	632	—	
8	200	502	740	—	502	740	—	502	740	—	502	740	—	502	740	—	
BODY	Stainless Steel					Stainless Steel			Cast Steel			Stainless Steel			Stainless Steel		
BONNET	Stainless Steel					Stainless Steel			Cast Steel			Stainless Steel			Stainless Steel		
STEM	Stainless Steel					Stainless Steel			Stainless Steel			Stainless Steel			Stainless Steel		
BALL	Stainless Steel					Stainless Steel			Stainless Steel			Stainless Steel			Stainless Steel		
SEAT	HYPATITE® PTFE					HYPATITE® PTFE			HYPATITE® PTFE			HYPATITE® PTFE			HYPATITE® PTFE		
	Full Port					Full Port			Full Port			Full Port			Full Port		

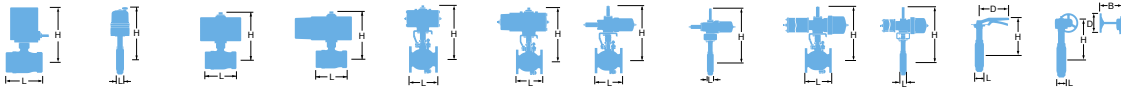
TYPE	BUTTERFLY			BUTTERFLY			BUTTERFLY			FLOATING BALL			FLOATING BALL				
Actuators Valves																	
FIG	B-10DJ			B-10DJE			B-10LJF			BS-10FCT			BS-10FCTB				
PRESSURE	10K			10K			10K			10K			10K				
END CONNECTION	Wafer Type (JIS 5K,10K)			Wafer Type (JIS 5K,10K)			Wafer Type (JIS 10K)			BS21 (JIS B0203)			JIS B2239				
DIMENSIONS	inch	mm	L	H	D	L	H	D	L	H	D	L	H	D	L	H	D
	3/8	10	—	—	—	—	—	—	—	—	—	72	202	—	—	—	—
	1/2	15	—	—	—	—	—	—	—	—	—	80	212	—	110	212	—
	3/4	20	—	—	—	—	—	—	—	—	—	85	215	—	120	215	—
	1	25	—	—	—	—	—	—	—	—	—	95	222	—	130	222	—
	1 1/4	32	—	—	—	—	—	—	—	—	—	120	298	—	140	298	—
	1 1/2	40	—	—	—	—	—	—	—	—	—	120	318	—	165	318	—
	2	50	43	374	—	43	374	—	43	369	—	140	365	—	180	365	—
	2 1/2	65	46	382	—	46	382	—	46	397	—	160	390	—	190	390	—
	3	80	46	420	—	46	420	—	46	404	—	182	464	—	200	464	—
	4	100	52	445	—	52	445	—	52	469	—	—	—	—	230	487	—
	5	125	56	473	—	56	473	—	56	504	—	—	—	—	300	600	—
	6	150	56	485	—	56	485	—	56	600	—	—	—	—	340	625	—
8	200	60	570	—	60	570	—	60	634	—	—	—	—	450	712	—	
10	250	68	709	—	68	709	—	68	736	—	—	—	—	533	772	—	
12	300	78	734	—	78	734	—	78	761	—	—	—	—	—	—	—	
BODY	Ductile Iron			Ductile Iron			Ductile Iron			Cast Iron			Cast Iron				
BONNET	—			—			—			Cast Iron			Cast Iron				
STEM	Stainless Steel			Stainless Steel			Stainless Steel			Stainless Steel			Stainless Steel				
BALL / DISC	Ductile Iron+ENP			Ductile Iron+ENP			Stainless Steel+PFA			Stainless Steel			Stainless Steel				
SEAT	NBR			EPDM			—			PTFE			PTFE				
	Ductile iron (Ni-plated) disc			Ductile iron (Ni-plated) disc			—			Full Port			Full Port				

Bronze & Brass
 Cast Iron
 Ductile Iron
 Stainless Steel
 Carbon Steel
 Butterfly Valve
 Ball Valve
 Ball Valve Seal
 Actuated Valve



TYPE	3WAY FLOATING BALL					FLOATING BALL			FLOATING BALL			FLOATING BALL			FLOATING BALL		
Actuators Valves																	
FIG	BS-10FCTB2L					BS-10STLBF			BS-10UT			BS-10UTDZ			BS-10UTDZM		
PRESSURE	10K					10K			10K			10K			10K		
END CONNECTION	JIS B2239					JIS B2239			BS21 (JIS B0203)			JIS B2220			JIS B2220		
DIMENSIONS	inch	mm	L	H	D	L	H	D	L	H	D	L	H	D	L	H	D
	3/8	10	-	-	-	-	-	-	62	202	-	-	-	-	-	-	-
	1/2	15	-	-	-	108	216	-	65	212	-	108	202	-	108	202	-
	3/4	20	-	-	-	117	219	-	80	215	-	117	205	-	117	205	-
	1	25	-	-	-	127	227	-	90	222	-	127	299	-	127	299	-
	1 1/4	32	-	-	-	140	302	-	110	298	-	140	303	-	140	303	-
	1 1/2	40	210	318	-	165	318	-	120	318	-	165	358	-	165	358	-
	2	50	220	367	-	178	365	-	140	365	-	178	367	-	178	367	-
	2 1/2	65	250	392	-	190	390	-	160	390	-	190	408	-	190	408	-
	3	80	260	464	-	203	464	-	182	464	-	203	470	-	203	470	-
	4	100	330	491	-	229	487	-	-	-	-	229	498	-	229	498	-
	5	125	-	-	-	356	600	-	-	-	-	356	599	-	356	599	-
	6	150	-	-	-	394	625	-	-	-	-	394	632	-	394	632	-
	8	200	-	-	-	457	712	-	-	-	-	457	740	-	457	740	-
	10	250	-	-	-	-	-	-	-	-	-	533	792	-	533	792	-
BODY	Cast Iron					Ductile Iron			Stainless Steel			Stainless Steel			Stainless Steel		
BONNET	Cast Iron					Ductile Iron			Stainless Steel			Stainless Steel			Stainless Steel		
STEM	Stainless Steel					Stainless Steel			Stainless Steel			Stainless Steel			Stainless Steel		
BALL	Stainless Steel					Stainless Steel			Stainless Steel			Stainless Steel			Stainless Steel		
SEAT	PTFE					PTFE			PTFE			HYPATITE® PTFE			HYPATITE® PTFE		
	Full Port					Full Port			Full Port			Full Port			Full Port		

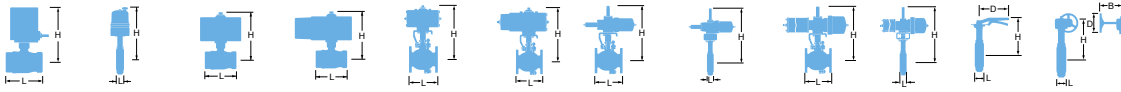
TYPE	FLOATING BALL					3WAY FLOATING BALL			3WAY FLOATING BALL			FLOATING BALL			LAMBDA PORT		
Actuators Valves																	
FIG	BS-10SCTDZ					BS-10UTB2L			BS-10UTB4LA			BS-10UTBLN			BS-10UVC		
PRESSURE	10K					10K			10K			10K			10K		
END CONNECTION	JIS B2220					JIS B2220			JIS B2220			JIS B2220			JIS B2220		
DIMENSIONS	inch	mm	L	H	D	L	H	D	L	H	D	L	H	D	L	H	D
	1/2	15	108	202	-	-	-	-	120	296	-	140	215	-	-	-	-
	3/4	20	117	205	-	-	-	-	140	299	-	152	217	-	-	-	-
	1	25	127	299	-	165	207	-	160	303	-	165	227	-	127	306	-
	1 1/2	40	165	358	-	210	318	-	180	380	-	191	322	-	165	369	-
	2	50	178	367	-	220	367	-	200	454	-	216	368	-	178	375.5	-
	2 1/2	65	190	408	-	250	392	-	240	473	-	240	392	-	190	459.5	-
	3	80	203	470	-	260	464	-	260	578	-	250	467	-	203	466	-
	4	100	229	498	-	330	491	-	330	600	-	280	493	-	229	493	-
	5	125	356	599	-	-	-	-	-	-	-	-	-	-	350	620.5	-
	6	150	394	632	-	-	-	-	-	-	-	-	-	-	394	638	-
	8	200	457	740	-	-	-	-	-	-	-	-	-	-	457	727	-
	10	250	533	792	-	-	-	-	-	-	-	-	-	-	533	751	-
BODY	Cast Steel					Stainless Steel			Stainless Steel			Stainless Steel			Stainless Steel		
BONNET	Cast Steel					Stainless Steel			Stainless Steel			Stainless Steel			Stainless Steel		
STEM	Stainless Steel					Stainless Steel			Stainless Steel			Stainless Steel			Stainless Steel		
BALL	Stainless Steel					Stainless Steel			Stainless Steel			Stainless Steel			Stainless Steel		
SEAT	HYPATITE® PTFE					HYPATITE® PTFE			HYPATITE® PTFE			HYPATITE® PTFE			-		
	Full Port					Full Port			Full Port			Full Port			Full Port		





TYPE	FLOATING BALL					FLOATING BALL			FLOATING BALL			FLOATING BALL			FLOATING BALL		
Actuators Valves																	
FIG	BS-150SCTDZ					BS-150UTDZ			BS-20SCTDZ			BS-20UTDZ			BS-20UTDZM		
PRESSURE	Class 150					Class 150			20K			20K			20K		
END CONNECTION	ASME B16.5					ASME B16.5			JIS B2220			JIS B2220			JIS B2220		
DIMENSIONS	inch	mm	L	H	D	L	H	D	L	H	D	L	H	D	L	H	D
	1/2	15	108	202	—	108	202	—	140	202	—	140	202	—	140	202	—
	3/4	20	117	205	—	117	205	—	152	205	—	152	205	—	152	205	—
	1	25	127	299	—	127	299	—	165	299	—	165	299	—	165	299	—
	1 1/4	32	—	—	—	140	303	—	—	—	—	178	303	—	178	303	—
	1 1/2	40	165	358	—	165	358	—	190	358	—	190	358	—	190	358	—
	2	50	178	367	—	178	367	—	216	367	—	216	367	—	216	367	—
	2 1/2	65	190	408	—	190	408	—	241	408	—	241	408	—	241	408	—
	3	80	203	470	—	203	470	—	283	470	—	283	470	—	283	470	—
	4	100	229	498	—	229	498	—	305	498	—	305	498	—	305	498	—
	5	125	356	599	—	356	599	—	381	599	—	381	599	—	381	599	—
6	150	394	632	—	394	632	—	403	632	—	403	632	—	403	632	—	
8	200	457	740	—	457	740	—	502	740	—	502	740	—	502	740	—	
10	250	533	792	—	533	792	—	—	—	—	—	—	—	—	—	—	
BODY	Cast Steel					Stainless Steel			Cast Steel			Stainless Steel			Stainless Steel		
BONNET	Cast Steel					Stainless Steel			Cast Steel			Stainless Steel			Stainless Steel		
STEM	Stainless Steel					Stainless Steel			Stainless Steel			Stainless Steel			Stainless Steel		
BALL	Stainless Steel					Stainless Steel			Stainless Steel			Stainless Steel			Stainless Steel		
SEAT	HYPATITE® PTFE					HYPATITE® PTFE			HYPATITE® PTFE			HYPATITE® PTFE			HYPATITE® PTFE		
	Full Port					Full Port			Full Port			Full Port			Full Port		

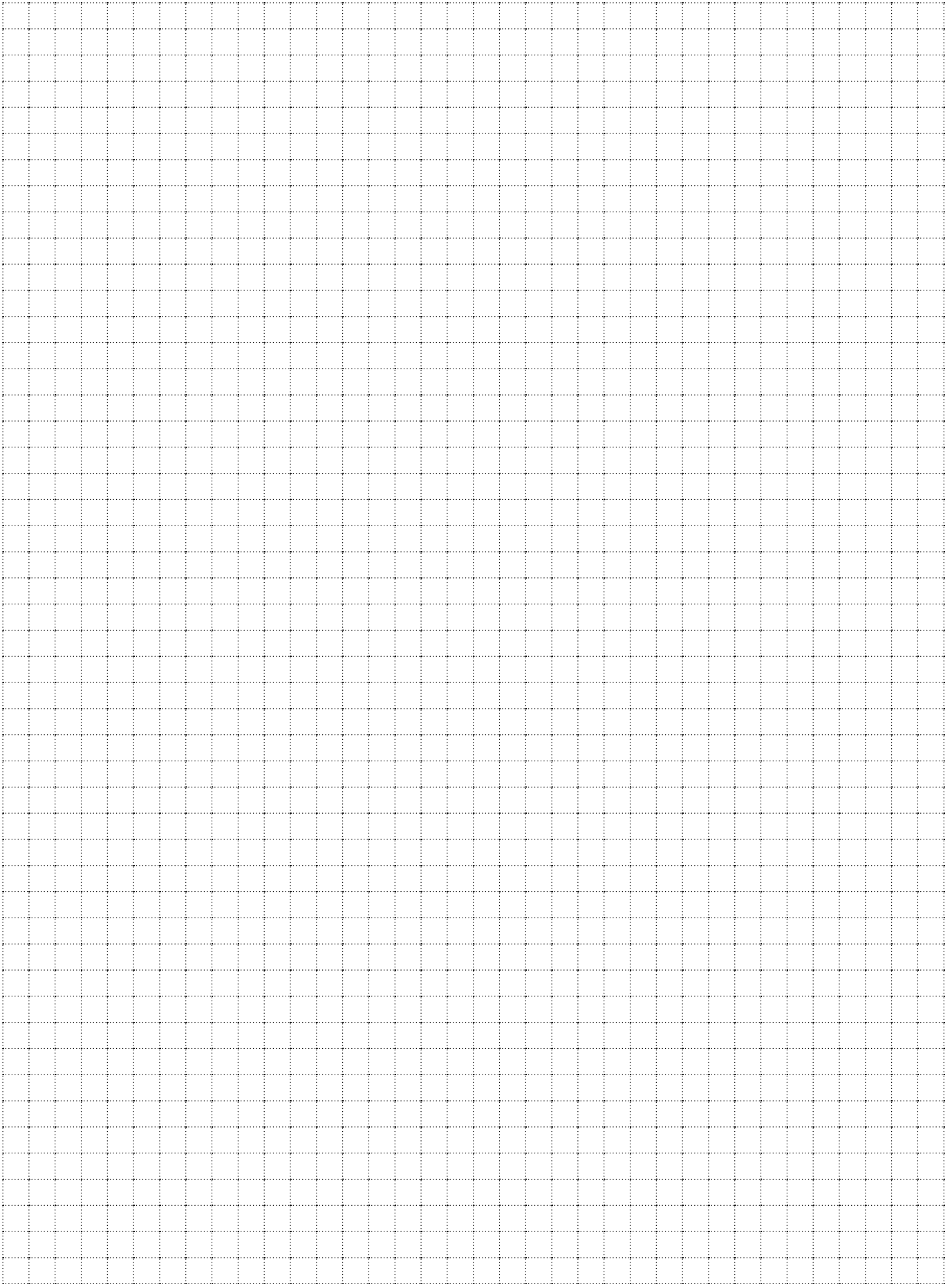
TYPE	FLOATING BALL					FLOATING BALL			FLOATING BALL			BUTTERFLY			BUTTERFLY		
Actuators Valves																	
FIG	BS-300SCTDZ					BS-300UTDZ			BS-300UTDZM			BS-10DJ			BS-10DJE		
PRESSURE	Class 300					Class 300			Class 300			10K			10K		
END CONNECTION	ASME B16.5					ASME B16.5			ASME B16.5			Wafer Type (JIS 5K,10K)			Wafer Type (JIS 5K,10K)		
DIMENSIONS	inch	mm	L	H	D	L	H	D	L	H	D	L	H	D	L	H	D
	1/2	15	140	202	—	140	202	—	140	202	—	—	—	—	—	—	—
	3/4	20	152	205	—	152	205	—	152	205	—	—	—	—	—	—	—
	1	25	165	299	—	165	299	—	165	299	—	—	—	—	—	—	—
	1 1/4	32	—	—	—	—	—	—	—	—	—	—	—	—	—	—	—
	1 1/2	40	190	358	—	190	358	—	190	358	—	33	355	—	33	355	—
	2	50	216	367	—	216	367	—	216	367	—	43	374	—	43	374	—
	2 1/2	65	241	408	—	241	408	—	241	408	—	46	382	—	46	382	—
	3	80	283	470	—	283	470	—	283	470	—	46	435	—	46	435	—
	4	100	305	498	—	305	498	—	305	498	—	52	445	—	52	445	—
	5	125	—	—	—	403	632	—	403	632	—	56	473	—	56	473	—
	6	150	403	632	—	502	740	—	502	740	—	56	545	—	56	545	—
	8	200	502	740	—	—	—	—	—	—	—	60	570	—	60	570	—
10	250	—	—	—	—	—	—	—	—	—	68	709	—	68	709	—	
12	300	—	—	—	—	—	—	—	—	—	78	734	—	78	734	—	
BODY	Cast Steel					Stainless Steel			Stainless Steel			Ductile Iron			Ductile Iron		
BONNET	Cast Steel					Stainless Steel			Stainless Steel			—			—		
STEM	Stainless Steel					Stainless Steel			Stainless Steel			Stainless Steel			Stainless Steel		
BALL / DISC	Stainless Steel					Stainless Steel			Stainless Steel			Ductile Iron+ENP			Ductile Iron+ENP		
SEAT	HYPATITE® PTFE					HYPATITE® PTFE			HYPATITE® PTFE			NBR			EPDM		
	Full Port					Full Port			Full Port			Ductile iron (Ni-plated) disc			Ductile iron (Ni-plated) disc		

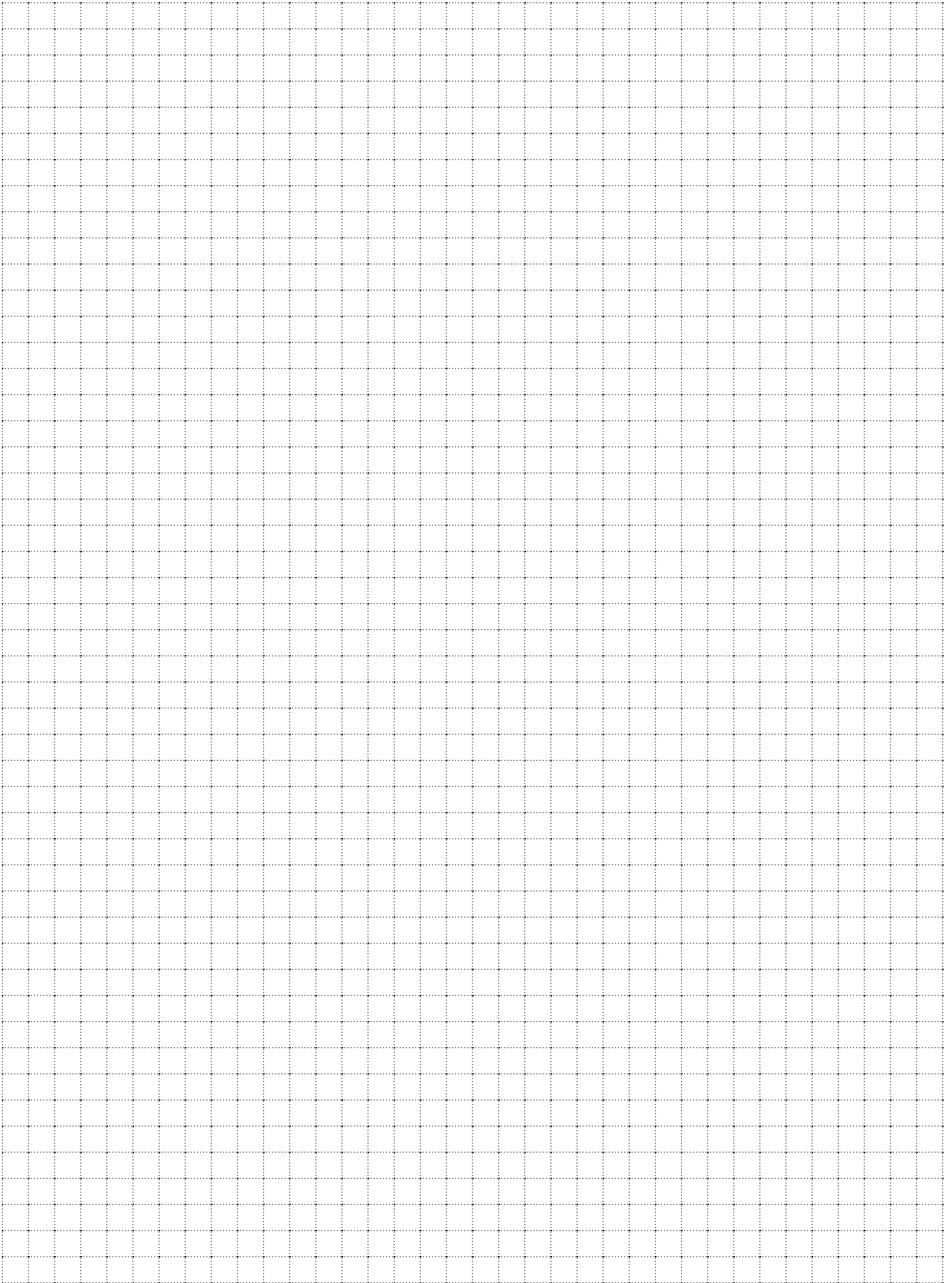
Bronze & Brass
 Cast Iron
 Ductile Iron
 Stainless Steel
 Carbon Steel
 Butterfly Valve
 Ball Valve
 Ball Valve Seal
 Actuated Valve



TYPE		BUTTERFLY				BUTTERFLY			
Actuators Valves		 NO IMAGE				 NO IMAGE			
FIG		BS-10LJF				BSW-10LJF			
PRESSURE		10K				10K			
END CONNECTION		Wafer Type (JIS 10K)				Wafer Type (JIS 10K)			
DIMENSIONS	inch	mm	L	H	D	L	H	D	
	2	50	43	384	—	43	384	—	
	2½	65	46	397	—	46	397	—	
	3	80	46	464	—	46	464	—	
	4	100	52	469	—	52	469	—	
	5	125	56	504	—	56	504	—	
	6	150	56	600	—	56	600	—	
	8	200	60	634	—	60	634	—	
	10	250	68	736	—	68	736	—	
	12	300	78	761	—	78	761	—	
BODY		Ductile Iron				Ductile Iron			
STEM		Stainless Steel				Stainless Steel			
BALL / DISC		Stainless Steel+PFA				Stainless Steel+PFA			

Bronze & Brass
 Cast Iron
 Ductile Iron
 Stainless Steel
 Carbon Steel
 Butterfly Valve
 Ball Valve
 Ball Valve Seat
 Actuated Valve





CAUTION

Pressure-temperature ratings and other performance data published in this catalog have been developed from our design calculation, in-house testing, field reports provided by our customers and/or published official standards or specifications. They are good only to cover typical applications as a general guideline to users of KITZ products introduced in this catalog.

For any specific application, users are kindly requested to contact KITZ Corporation for technical advice, or to carry out their own study and evaluation for proving the suitability of these products to such an application. Failure to follow this request could result in property damage and/or personal injury, for which we shall not be liable.

While this catalog has been compiled with the utmost care, we assume no responsibility for errors, impropriety, or inadequacy. Any information provided in this catalog is subject to from-time-to-time change without notice for error rectification, product discontinuation, design modification, new product introduction, or any other cause that KITZ Corporation considers necessary. This edition cancels all previous issues.

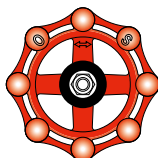
Read the instruction manual carefully before use.

NOTICE

If any products designated as strategic material in the Foreign Exchange and Foreign Trade Law, Cabinet Order Concerning Control of Export Trade, Cabinet Order Concerning Control of Foreign Exchange, and other related laws and ordinances ("Foreign Exchange Laws") are exported to any foreign country or countries, an export license issued by the Japanese Government will be required under the Foreign Exchange Laws.

Further, there may be cases where an export license issued by the government of the United States or other country will be required under the applicable export-related laws and ordinances in such relevant countries.

The contract shall become effective subject to the fact that a relevant export license is obtained from the Japanese Government.



*A chrysanthemum-handle is a symbol of KITZ,
the brand of valve reliability*

ISO 9001 certified since 1989

KITZ
KITZ CORPORATION

1-10-1 Nakase, Mihama-ku, Chiba 261-8577, Japan
International Sales Dept.
Phone : 81-43-299-1730
Fax : 81-43-299-0121

— Distributed by —